

# Bidding Document

**MADHYANCHAL VIDYUT VITRAN NIGAM  
LIMITED (MVVNL)**

**Request for Proposal**

**For**

**Appointment of Advanced Metering Infrastructure  
(AMI) Service Provider for Smart Prepaid Metering  
in MVVNL (U.P.) India on DBFOOT basis**

**Request for Proposal (RFP): RDSS/0002/2022**

Superintending Engineer (Commercial)

MVVNL Head Office,

4-A, Gokhale Marg,

Lucknow (U.P.)-226001

Phone: +91-8004922297

Email: mvvnlsmrds@gmail.com

Last date of Submission: 03.09.2022

Cost of Bid document (Bid Fee): INR 50,000.00+GST @18%

Bid Security: INR 2,00,00,000/- (INR Two Crore Only)

## Guidance Note

<The terms and conditions of this RFP have been defined considering full implementation of AMI Project at the Utility level. Utility may decide phase-wise roll-out of such AMI Project.  
>

General Instructions for Utility:

- a) Note 1: The provisions in angle brackets (< >) are for guidance and should be omitted from the RFP before it is issued to prospective Bidders.
- b) Note 2: All Project-specific provisions in this RFP have been enclosed in square parenthesis ([ ]) and may be modified, as necessary, before issuing the RFP to prospective Bidders. The square parenthesis should be removed after carrying out the required modification>

Instructions for Utility:

1. Incorporation of a Special Purpose Vehicle (SPV) by the Selected Bidder for project implementation would be mandatory, in both cases, where the Bidder is either a Sole bidder or a bidding Consortium.
2. However, if a Central Public Sector Enterprise (CPSE) / Public Sector Undertaking (PSU) or Subsidiary/ Joint Venture of a CPSE/ PSU is either the sole Bidder or a lead member of a Bidding Consortium, then creation of an SPV is not mandatory. In such an event, the following changes as mentioned in (3) below may be required to be made in the contract.
3. Changes required:
  - a. Article 1.1(j) of GCC, Section 7: Definitions. “AMISP Contract” or “Contract” should be modified at the time of award of contract.

### Existing

“AMISP Contract” or “Contract” shall mean this Contract entered into between, the SPV incorporated by the Selected Bidder (if applicable and so indicated in SCC), Selected Bidder (represented by the Lead Member acting for and on behalf of the consortium if the Selected Bidder is a consortium) and the Utility for undertaking the AMI Project and is the legally binding written agreement signed by the Parties and which includes all the attached documents listed in its paragraph 1 of the Form of Contract (the General Conditions (GCC), the Special Conditions (SCC), and the Appendices, Attachments, Annexures etc.).

### Modified

“AMISP Contract” or “Contract” shall mean the Contract to be entered into between Selected Bidder and the Utility for undertaking the AMI Project and is the legally binding written agreement signed by the Parties and which includes all the attached documents listed in its paragraph 1 of the Form of Contract (the

General Conditions (GCC), the Special Conditions (SCC), and the Appendices, Attachments, Annexures etc.);

- b. Article 1.2.1 of Section 7 shall be modified at the time of award of contract as under:

**Existing**

Utility, the Selected Bidder, and the AMISP/ Contractor shall individually be referred to as “Party” and collectively as “Parties.”

**Modified**

Utility and the AMISP/ Contractor shall individually be referred to as “Party” and collectively as “Parties.”

4. The execution page would have to modified to remove reference to Selected Bidder

## **Tender Disclaimer**

To be provided by **MVVNL**

---

## **SUMMARY**

### **PART I – BIDDING PROCEDURES AND REQUIREMENTS**

#### **Section 1: Request for Proposals (RFP) Notice**

This Section includes Request for Proposals.

#### **Section 2: Eligibility and Qualification Requirements**

This Section contains information regarding specific eligibility and qualification requirements applicable for prospective bidders to be considered for further evaluation of their proposal.

#### **Section 3: Instructions to Bidders and Bid Data Sheet**

This Section consists of two parts: “Instructions to Bidders” and “Bid Data Sheet”. “Bid Data Sheet” contains information specific to selection and corresponds to the clauses in “Instructions to Bidders” that call for selection-specific information. This Section provides information to help prospective bidders prepare their proposals. Information is also provided on submission, opening and evaluation of proposals, selection of successful bidder and award of contract.

#### **Section 4: Bidding Forms – Technical Proposal**

This Section includes the forms for Technical Proposal that are to be completed by the prospective bidders and submitted in accordance with the requirements of Section 3.

#### **Section 5: Bidding Forms - Financial Proposal**

This Section includes the financial forms that are to be completed by the prospective bidders, including the bidders’ costing and pricing, which are to be submitted in accordance with the requirements of Section 3.

#### **Section 6: Project Requirements**

This Section describes the background information of the Project, Scope, of Work, System Requirement, Specifications, Quality Requirements, Service Level Agreement (SLA), Standards, Activities and Tasks, Plans, Deliverables, Documentation, and other requirements/ details related to and/or connected with the Project.

### **PART II – CONTRACT FORM AND CONDITIONS OF CONTRACT**

#### **Section 7: Contract Form and Conditions of Contract**

This Section includes standard contract form. It includes General Conditions of Contract (“GCC”) and Special Conditions of Contract (“SCC”). The SCC include clauses specific to this contract to supplement the General Conditions.

### **PART III – Contract Related Forms**

#### **Section 8: Contract Related Forms**

This Section includes the form used to notify Award of the Contract to the successful bidder and the form for Performance Security to be furnished by the bidder.

## ABBREVIATIONS

1.	<b>AMI</b>	Advanced Metering Infrastructure
2.	<b>ACI</b>	Available Capital for Investment
3.	<b>AMISP</b>	Advanced Metering Infrastructure Service Provider
4.	<b>BG</b>	Bank Guarantee
5.	<b>BIS</b>	Bureau of Indian Standards
6.	<b>BoM</b>	Bill of Material
7.	<b>C&amp;I</b>	Commercial and Industrial
8.	<b>CAIDI</b>	Consumer Average Interruption Duration Index
9.	<b>CAIFI</b>	Consumer Average Interruption Frequency Index
10.	<b>CEA</b>	Central Electricity Authority
11.	<b>CERT-In</b>	Indian Computer Emergency Response Team
12.	<b>CIM</b>	Common Information Model
13.	<b>CIS</b>	Consumer Information System
14.	<b>CMMI</b>	Capability Maturity Model Integration
15.	<b>CPU</b>	Central Processing Unit
16.	<b>CRM</b>	Consumer Relationship Management
17.	<b>CT</b>	Current Transformer
18.	<b>CUM</b>	Cumulative
19.	<b>CV</b>	Curriculum Vitae
20.	<b>DBFOOT</b>	Design Build Finance Own Operate and Transfer
21.	<b>DBMS</b>	Database Management System
22.	<b>DCU</b>	Data Concentrator Unit
23.	<b>DMZ</b>	Demilitarized Zone
24.	<b>DT</b>	Distribution Transformer
25.	<b>ESB</b>	Enterprise Service Bus
26.	<b>FAT</b>	Factory Acceptance Test
27.	<b>FOR</b>	Freight on Road
28.	<b>GIS</b>	Geographic Information System

29.	<b>GPRS</b>	General Packet Radio Service
30.	<b>GPS</b>	Global Positioning System
31.	<b>GST</b>	Goods and Services Tax
32.	<b>GUI</b>	Graphical User Interface
33.	<b>HES</b>	Head-End System
34.	<b>HHU</b>	Handheld Unit
35.	<b>IBMS</b>	Integrated Building Management Systems
36.	<b>IDS</b>	Intrusion Detection Systems
37.	<b>IEC</b>	International Electrotechnical Commission
38.	<b>IP</b>	Internet Protocol
39.	<b>IPR</b>	Intellectual Property Rights
40.	<b>IS</b>	Indian Standard
41.	<b>ISO</b>	International Organization for Standardization
42.	<b>ISP</b>	Internet Service Provider
43.	<b>IT</b>	Information Technology
44.	<b>IVRS</b>	Interactive Voice Response System
45.	<b>Kva</b>	kilo Volt-Ampere
46.	<b>Kw</b>	kilo Watt
47.	<b>LAN</b>	Local Area Network
48.	<b>LCD</b>	Liquid Crystal Display
49.	<b>LED</b>	Light Emitting Diode
50.	<b>LT</b>	Low Tension
51.	<b>M&amp;V</b>	Monitoring and Verification
52.	<b>MCB</b>	Miniature Circuit Breaker
53.	<b>MD</b>	Maximum Demand
54.	<b>MDAS</b>	Meter Data Acquisition System
55.	<b>MDM</b>	Meter Data Management
56.	<b>MICC</b>	Mineral-Insulated Copper-Clad Cable
57.	<b>NAN</b>	Neighborhood Area Network
58.	<b>NIC</b>	Network Interface Card

59.	<b>NMS</b>	Network Management System
60.	<b>NOMC</b>	Network Operation cum Monitoring Center
61.	<b>NTP</b>	Network Time Protocol
62.	<b>OEM</b>	Original Equipment Manufacturer
63.	<b>OS</b>	Operating System
64.	<b>OSF</b>	Open Software Foundation
65.	<b>P&amp;L</b>	Profit & Loss
66.	<b>PCI</b>	Payment Card Industry
67.	<b>PLC</b>	Power Line Communication
68.	<b>PLCC</b>	Power Line Carrier Communication
69.	<b>PO</b>	Purchase Order
70.	<b>PON</b>	Power Outage Notification
71.	<b>PRN</b>	Power Restoration Notification
72.	<b>PT</b>	Potential Transformer
73.	<b>PV</b>	Photovoltaic System
74.	<b>QA</b>	Quality Assurance
75.	<b>QC</b>	Quality Control
76.	<b>QR</b>	Qualification Requirement
77.	<b>RAM</b>	Random Access Memory
78.	<b>RDBMS</b>	Relational Database Management System
79.	<b>RF</b>	Radio Frequency
80.	<b>RFP</b>	Request for Proposal
81.	<b>RPO</b>	Recovery Point Objective
82.	<b>RTC</b>	Real Time Clock
83.	<b>RTO</b>	Recovery Time Objective
84.	<b>SAIDI</b>	System Average Interruption Duration Index
85.	<b>SAIFI</b>	System Average Interruption Frequency Index
86.	<b>SAN</b>	Storage Area Network
87.	<b>SAT</b>	Site Acceptance Test
88.	<b>SCADA</b>	Supervisory Control and Data Acquisition



89.	<b>SEBI</b>	Securities and Exchange Board of India
90.	<b>SI</b>	System Integrator OR System Integration
91.	<b>SLA</b>	Service Level Agreement
92.	<b>SNMP</b>	Simple Network Management Protocol
93.	<b>SOA</b>	Service Oriented Architecture
94.	<b>SQL</b>	Structured Queried Language
95.	<b>TCP</b>	Transmission Control Protocol
96.	<b>TOD</b>	Time of Day
97.	<b>TOU</b>	Time of Use
98.	<b>UDP</b>	User Datagram Protocol
99.	<b>UPS</b>	Uninterrupted Power Supply
100.	<b>VEE</b>	Validation Estimation and Editing
101.	<b>VM</b>	Virtual Machine
102.	<b>VoIP</b>	Voice over Internet Protocol
103.	<b>WAN</b>	Wide Area Network
104.	<b>WO</b>	Work Order
105.	<b>WPC</b>	Wireless Planning & Coordination Wing
106.	<b>XML</b>	Extensible Mark-up Language
107	<b>ITB</b>	Instruction to Bidder

## TABLE OF CONTENT

Guidance Note .....	2
<b>PART I.....</b>	<b>11</b>
Section – 1: Request for Proposal Notice.....	12
Section – 2: Eligibility and Qualification Requirements.....	16
Section – 3: Instructions to Bidders and Bid Data Sheet.....	27
Section 4. Bidding Forms- Technical Proposal .....	69
Section 5. Financial Proposal - Forms.....	145
Section 6. Project Requirements .....	154
Section 7. Contract Form and Conditions of Contract .....	351
Section 8. Contract Related Forms.....	412

**PART I**

**BIDDING PROCEDURES AND REQUIREMENTS**

## Section – 1: Request for Proposal Notice

### “Appointment of Advanced Metering Infrastructure (AMI) Service Provider for Smart Prepaid Metering in MVVNL, Uttar Pradesh, India on DBFOOT basis”

#### PROCUREMENT NOTICE

(Single Stage Two-Envelope Bidding Process with e-Procurement)

#### GLOBAL OPEN COMPETITIVE PROCUREMENT

**Contract Title: “Appointment of Advanced Metering Infrastructure (AMI) Service Provider for Smart Prepaid Metering in MVVNL, Uttar Pradesh, India on DBFOOT basis”**

**Request for Proposal (RFP)/ Tender Number: RDSS/0002/2022**

**Issued on: 02.08.2022**

1. **MVVNL** (hereinafter also referred to as ‘**MVVNL**’) invites online Proposals for “**Appointment of Advanced Metering Infrastructure (AMI) Service Provider for Smart Prepaid Metering in MVVNL, Uttar Pradesh, India on DBFOOT basis**”. Bidders are advised to note the clauses on Eligibility and Qualification Requirements in Section-2 and Evaluation Criteria in Section-3 of the RFP Document for evaluation of Proposals.
2. Bidding for selection of AMI Service Provider will be conducted through global open competitive procurement.
3. The RFP Document is available online on <https://etender.up.nic.in> from 08.08.2022 to 03.09.2022 on payment of cost of document (Tender Fee) as indicated in the TABLE below. The prospective Bidders would be responsible for downloading the RFP Document and ensuring that any addenda/ corrigendum/ amendment/ clarification thereto available on the website is also downloaded and incorporated.
4. The bidding shall be conducted **under Single Stage Two-Envelope Bidding process with e-Procurement** as specified in Section 3.
5. Under the Single Stage Two-Envelope Bidding process, the Bidder shall not quote, disclose, or submit its price in the Technical Proposal (First Envelope) or in any other manner, whatsoever, except as part of the Financial Proposal (Second Envelope). In case of any non-compliance in this regard, the Proposal shall be out-rightly / summarily rejected.

6. An incomplete and/or ambiguous and/or conditional Proposal and/or Proposal submitted late is liable to be ignored/ summarily rejected.
7. Proposal must be submitted online through the e-Procurement/ e-Tendering process specified in Section 3. Any Proposal or modifications to Proposal received outside the e-Procurement system will not be considered, unless otherwise specified in Section 3. **MVVNL** shall not be held liable for any delays due to e-Procurement/ e-Tendering system failure beyond its control. Even though the system will attempt to notify the bidders of any bid updates, **MVVNL** shall not be liable for any information not received by the bidder. It is the bidders' responsibility to verify the website for the latest information related to this RFP.
8. Important dates, amounts and other details pertaining to this RFP Notice including submission and opening of proposal, cost of documents/ Tender Fee, address for communication, etc., are given in the TABLE below.
9. If **MVVNL** office happens to be closed on the specified date of opening of the Proposals, the Proposals/ bids will be opened on the next working day at the same time and venue or as may be notified by **MVVNL**.
10. Other details can be seen in the RFP document.

## TABLE

### Important Dates, Amounts and Other Details

#### Dates

		Date	Time
a)	Commencement of downloading of this RFP and e-bidding	08.08.2022	11:00 hrs
b)	<del>Pre-bid meeting</del> Submission of query through E-mail- <a href="mailto:mvvnlsmrds@gmail.com">mvvnlsmrds@gmail.com</a> on RFP	12.08.2022	17:00 hrs
c)	Last date for submission of e-bid	03.09.2022	17:00 hrs
d)	<del>Last date for receipt of RFP</del> Opening Date of e-bid Part-1	05.09.2022	16:00 hrs
e)	<del>Date of Opening of Technical Bid (if possible)</del> Opening Date of e-bid Part-2	To be provided latter	

#### Amounts for Bidding

A.	Tender Fee to be submitted with the RFP (Non- Refundable)	: INR 50,000 + GST @18%	Fifty thousand + GST rupees only
B.	Bid Security (Refundable)	: INR 2,00,00,000	Two crores rupees only
C.	Other Payments or Bank Guarantees for the AMISP shall be as per the terms and conditions defined in this RFP		

#### Other Details

A.	Address for Communication including Contact details: Superintending Engineer (Commercial) MVVNL Head Office, 4-A, Gokhale Marg, Lucknow (U.P.)-226001 Phone: +91-8004922297 Email: <a href="mailto:mvvnlsmrds@gmail.com">mvvnlsmrds@gmail.com</a>
----	---

B.	<p>Payment of cost of document/ Tender Fee:</p> <ol style="list-style-type: none"> <li>1. Tender Fee shall be made in the form of A/C payee demand draft or RTGS drawn on any indian Scheduled Commercial Bank in favour of Executive Engineer to Managing Director, MVVNL, Lucknow payable at Lucknow Bank Name State Bank of India Account Number- 10101985738 IFSC Code- SBIN0003347 Branch Name- State Bank of India, Ashok Marg, Lucknow</li> <li>2. Tender Fee (or its receipt in case of RTGS payment) and Bid Security must be submitted in physical form in a sealed envelope at address given above, before the Bid Submission Deadline. The sealed envelope shall be clearly marked on the top as “Tender Fee for Appointment of Advanced Metering Infrastructure (AMI) Service Provider for Smart Prepaid Metering in MVVNL (U.P.) India on DBFOOT basis.” The sealed envelope shall also clearly mention the name of the Lead Consortium Member/ Sole Bidder submitting the Bid, as further detailed in Section 3.</li> <li>3. Any Bid not accompanied by a Tender Fee as above shall be rejected by <b>MVVNL</b> as non-responsive.</li> <li>4. Tender Fee is non-refundable</li> </ol>
C.	<p>Other Payments or Bank Guarantees for the RFP/ Contract shall be as per the terms and conditions defined in this RFP Document. Bank Account Details are as follows:</p> <p><b>Executive Engineer to Managing Director, MVVNL, Lucknow</b>  <b>Bank Name- State Bank of India</b>  <b>Account Number- 10101985738</b>  <b>IFSC Code- SBIN0003347</b>  <b>Branch Name- State Bank of India, Ashok Marg, Lucknow</b></p>
D.	<p>Bidder has to provide name of Company, Company Address, contact name and Mobile number in the query submitted by Bidders on email.</p> <p>Superintending Engineer (Commercial)  MVVNL Head Office,  4-A, Gokhale Marg,  Lucknow (U.P.)-226001  Phone: +91-8004922297  Email: <a href="mailto:mvvnlsmdss@gmail.com">mvvnlsmdss@gmail.com</a></p>

## Section – 2: Eligibility and Qualification Requirements

1. The Bid can be submitted by a Sole Bidder as an individual entity or a Consortium of firms/companies (specific requirements for Consortium are given under Clause 4 below) who are eligible to participate in tenders for public procurement in India in accordance with Applicable Laws including the guidelines issued in Order No. F/No.6/18/2019-PPD by Ministry of Finance, Department of Expenditure, Public Procurement Division dated 23 July 2020, Order No. No.9/16/2016-Trans-Part (2) dated 18 November 2020, latest Government of India Guidelines for Make in India, Domestically manufactured products, Atmanirbhar Bharat and circulars DIPP Office Memorandum No. P-45021/2/2017-PP (BE-II) date: 16th Sept. 2020, MeitY Circular No.1(10)/2017-CLES dated 06.12.2019 and Order No. 11/05/2018-Coord. by the Ministry of Power dated 17 September 2020 including any amendments or modifications to the same from time to time.
2. If at any stage of the bidding, any order/ ruling is found to have been passed in the last 1 (one) year preceding the Bid submission deadline by a competent Court of Law or any appropriate Commission or any Arbitral Tribunal against the Sole Bidder/ Lead Bidder/ any Consortium Members or its Affiliates for breach of any Contract awarded by any Government agency/department, then Bids from such Bidders shall be liable to be rejected. All Bidders shall confirm in accordance to Form 7 given in Section 4 that no such order(s)/ ruling(s) have been passed by a competent Court of Law or an appropriate Commission against it or its Affiliates. In case of any such order/ ruling, it is the duty of the Bidder to inform **MVVNL** for the same during the Bid submission.
3. Technically qualified Bidders shall continue to maintain compliance with the Eligibility and Qualification Requirements specified herein. Failure to comply with the aforesaid requirements shall make the Bid from such Bidders liable for rejection at any stage of the bidding process.
4. **Eligibility Requirements for Consortium**
  - 4.1 Members of the Consortium shall enter into a binding Consortium Agreement, in the form specified at Form 8 (the “Consortium Agreement”) given in Section 4 of RFP Document, for the purpose of submitting Bid. The Consortium Agreement, to be submitted along with the Bid, shall, inter alia:
    - (a) convey the intent to comply with the terms and conditions of the AMISP Contract in the event selected to undertake the Project; and
    - (b) clearly outline the proposed roles and responsibilities, if any, of each member.
  - 4.2 In the event Selected Bidder is a bidding Consortium, except in the case when a Central Public Sector Enterprise (CPSE) / Public Sector Undertaking (PSU) or Subsidiary/ Joint Venture of a CPSE/ PSU is the lead consortium member, then the members of the consortium shall be required to form an appropriate Special Purpose Vehicle, incorporated under the Companies Act 2013 (the “SPV”), to execute the AMISP Contract and implement the Project. In such a case, the Selected Bidder shall comply with the following requirements:
    - 4.2.1 The members of the consortium shall ensure that they subscribe to 100% of the equity share capital of the SPV. The members of the Consortium shall hold shares in accordance with the shareholding pattern indicated in the Consortium Agreement for a period up to two years after the Installation Milestone;
    - 4.2.2 The members of the consortium shall continue to hold not less than 51% for the entire term of the AMISP Contract;



- 4.2.3 The Lead Consortium Member shall hold at least 51% (fifty-one per cent) of the equity of the SPV at all times until two years from Installation Milestone as per the AMISP Contract and 26% for the remaining term of the AMISP Contract.
- 4.2.4 If equity is held by the Affiliates, Parent Company or Ultimate Parent Company, then subject to this Clause, such Affiliate, Parent Company or Ultimate Parent Company shall be permitted to transfer its shareholding in the SPV to another Affiliate or to the Parent Company / Ultimate Parent Company. If any such shareholding entity, qualifying as an Affiliate / Parent Company / Ultimate Parent Company, is likely to cease to meet the criteria to qualify as an Affiliate / Parent Company / Ultimate Parent Company, the shares held by such entity shall be transferred to another Affiliate / Parent Company / Ultimate Parent Company.

Provided that in case the Lead Member or Sole Bidder is holding equity through Affiliate's, Ultimate Parent Company or Parent Company, such restriction shall apply to such entities.

Provided further, that the aggregate equity share holding of the Bidding Consortium or a Sole Bidder in the issued and paid-up equity share capital of the SPV shall not be less than hundred percent (100%) up to a period of two (2) years after Installation Milestone and the lead Consortium Member shall have the equity share holding not less than fifty one percent (51%). In case the Selected Bidder is a Bidding Consortium. then any Member (other than the Lead Member) of such Bidding Consortium shall be allowed to divest its equity as long as the other remaining Members (which shall always include the Lead Member) hold the minimum equity specified above.

- 4.2.5 The Selected Bidder may invest in the equity share capital of the SPV through its Affiliate(s) or Ultimate Parent Company or Parent Company. Details of such investment will have to be specified in the Technical Bid of the RFP. If the Selected Bidder so invests through any Affiliate(s) or Ultimate Parent Company or Parent Company, the Selected Bidder shall be liable to ensure that minimum equity holding/lock-in limits as specified in Clause 4.2 above and as computed as per the provisions of Clause 4.2.6 of this section are still maintained.
- 4.2.6 For computation of effective Equity holding, the Equity holding of the Selected Bidder or its Ultimate Parent Company in such Affiliate(s) or Parent Company and the equity holding of such Affiliate (s) or Ultimate Parent company in the SPV shall be computed in accordance with the example given below:

If the Parent Company or the Ultimate Parent Company of the Selected Bidder A directly holds thirty percent (30%) of the equity in the SPV, then holding of Selected Bidder A in the SPV shall be thirty percent (30%);

If Selected Bidder A holds thirty percent (30%) equity of the Affiliate and the Affiliate holds fifty percent (50%) equity in the SPV, then for the purposes of ascertaining the minimum equity/equity lock-in requirements specified above, the effective holding or Bidder A in the SPV shall be fifteen percent (15%). (i.e., 30%\*50%);

- 4.3 The Lead Bidder / Sole Bidder shall have a registered office (under the Companies Act 1956/ 2013 with Registrar of Companies) in India at the time of submission of the Bid. In case of Award of Contract, other Consortium Members shall be required to have a registered office (under the Companies Act 1956/ 2013 with Registrar of Companies) in India.

- 4.4 Every Consortium Member shall provide consent to the Lead Consortium Member and make itself aware of all the proceedings of the bidding process and Project implementation through legally enforceable Consortium Agreement, power of attorneys, legal undertakings, etc. (if applicable) entered amongst all members of that Bidding Consortium including but not limited to those as prescribed in Form 8, Form 9 and Form 11 given in Section 4. In the absence of duly executed formats, the Bid shall not be considered for evaluation and shall be rejected.
- 4.5 The Lead Consortium Member shall be liable for the execution of the entire obligation in the AMISP Contract in accordance with the terms and conditions thereof. Only the Lead Consortium Member shall have the authority to conduct all businesses for and on behalf of the Consortium during the bidding process.
- 5.1 The Bidder, participating in the bid as a Sole Bidder, or as a Consortium Member or as Lead Consortium Member of a Bidding Consortium, and its Sub-Contractor(s) should not be blacklisted by any Govt. Organization or regulatory agencies or Govt. Undertaking as on the date of submission of the Bid. Bidder should submit a self-undertaking signed by its authorized signatories for the same as per the format prescribed in Form 7 given in Section 4.
- 5.2 The Bidder, participating in the bid as a Sole Bidder, or as a Consortium Member or as Lead Consortium Member, and its Sub-Contractor(s) shall not be banned/ debarred by the **MVVNL** or any of its subsidiaries/ holding company, as on the date of submission of the Bid. Bidder should submit a self-undertaking signed by its authorized signatories for the same as per the format prescribed in Form 7 given in Section 4.
6. The Lead Consortium Member/ Sole Bidder shall submit the Bid after submitting the Tender Fees and Bid Security as per the various terms, schedules and formats prescribed in this RFP. Further, The Lead Consortium Member shall be the point of contact for the Consortium during the Bid process before award of the Project to the AMISP, and **MVVNL** shall communicate directly to the contact person appointed through the Power of Attorney as per Form 10 given in Section 4.
7. The Bidder may seek qualification on the basis of technical and financial capability of its Parent(s) and/ or its Affiliate(s), as defined in section 3, for the purpose of meeting the qualification requirements. Authorization for use of such technical or financial capability shall have to be provided from its Parent(s) and/or Affiliate(s). A Bidder shall submit only one Bid in the same bidding process, either individually as a Sole Bidder or as a Lead Member of a Bidding Consortium. Any member of the bidding consortium, including its Parent(s) and/or Affiliate(s), whose technical and financial capabilities are showcased for meeting the criteria as mentioned in Clause 8.1 of Section 2, shall not separately participate directly or indirectly in another bid in the same bidding process for meeting the criteria as mentioned in Clause 8.1 of section 2.

The determination of the relationship of Parent(s) and/or Affiliate(s) with the Bidder shall be on the date 7 (seven) Days prior to the Bid Submission Deadline. Documentary evidence to establish such relationship shall be furnished by the Bidder along with the Technical Bid.

If the Technically Evaluated Entity and/or Financially Evaluated Entity is an entity other than the Sole Bidder or a Member in a Bidding Consortium, the Sole Bidder or Member relying on such Technically Evaluated Entity and/or Financially Evaluated Entity will have to submit a legally binding undertaking supported by a board resolution from the Technically Evaluated

Entity and/or Financially Evaluated Entity or its Ultimate Parent Company, that all the equity investment obligations of the Sole Bidder or the Member of the Consortium shall be deemed to be equity investment obligations of the Technically Evaluated Entity and/or Financially Evaluated Entity or its Ultimate Parent Company, and in the event of any default the same shall be met by such evaluated entity or by the Ultimate Parent Company. The Sole Bidder or the Consortium Member shall have to provide information and documents relating to its relationship with such Technically Evaluated Entity and or Financially Evaluated Entity including details about the equity shareholding between them as per Form 16 provided in Section 4.

The Technically Evaluated Entity may be the Sole Bidder or the Lead Member of a Consortium or an Affiliate or Parent of such Sole Bidder or the Lead Member, as the case may be.

The Qualified Bidder(s) will be required to continue to maintain compliance with the Qualification Requirements throughout the bidding process and till execution of the AMISP Contract. Where the Technically Evaluated Entity and/or the Financially Evaluated Entity is not the Sole Bidder or a Member in a Bidding Consortium, as the case may be, the Sole Bidder or Member shall continue to be an Affiliate of the Technically Evaluated Entity and/or Financially Evaluated Entity till the execution of the AMISP Contract. Failure to comply with the aforesaid provisions shall make the Bid liable for rejection at any stage.

## 8. Qualification Requirements

8.1 The technical and financial requirements of qualification are as follows:

S. No.	Requirements	Supporting Documents
<b>Technical Requirements</b>		
1.	<p>Sole/ Lead Bidder must have either:</p> <p>(a) paid for, or received payments for, construction of Eligible Project(s);</p> <p style="text-align: center;"><b><u>Or</u></b></p> <p>(b) paid for development of Eligible project(s)</p> <p>in the infrastructure sector in the last 7 (seven) Financial Years with aggregate project value of not less than INR [50% of the Estimated Project Cost]</p>	<p>a) References along with requisite contract/ Purchase Order (PO)/ Work Order (WO). The references should indicate client name, scope of work, Project start date (as per the format prescribed in Form 13 given in Section 4);</p> <p>b) Documentary evidence of completion of the Project or completion of Go-live status (i.e., Go-live certificate, UAT testing certificate etc.) of the respective project as per the definition of Go-Live/ UAT specified therein or other documentary evidence indicating</p>
2.	<p>Sole/ Lead Bidder/ any other Consortium Member must have experience of integration of head-end system with MDM on standard interfaces and data exchange models for at least [20,000] consumers / end points (cumulatively) in an Indian/ Global Utility (power/ water/ natural gas/ telecom) in the last 7 (seven) years which are in operation for</p>	

S. No.	Requirements	Supporting Documents
	<p>at least 1 (one) year.</p> <p><b><u>Or</u></b></p> <p>Sole/ Lead Bidder/ any other Consortium Member should have installed, integrated, tested, and commissioned control center hardware (or on cloud) and application software for at least [50,000] endpoints (cumulatively) in an Indian/ Global Utility (power/ water/ natural gas/ telecom) in last 7 (seven) years which are in operation for at least 1(one) year</p>	<p>completion (e.g., proof of payment received/ proof of asset capitalized in books of accounts (as applicable) and client certificate for supply of material or similar proofs) along with contact details of the client;</p> <p>c) Client certificate and other documentation for implementation performance/ operation</p>
3.	<p>The Sole/ Lead Bidder should have a valid pre-qualification and technical empanelment certificate for the required communication technology, issued by REC and approved by the committee constituted vide the letter issued by the Ministry of Power F.No.14/02/2021-UR&amp;SI-II-Part(1)-(E-258136) dt. 10<sup>th</sup> January 2022, at the time of bid submission.</p>	<p>Valid Empanelment certificate of the sole/ lead bidder for the proposed solution, issued by REC / committee constituted thereby</p>
<b>Financial Requirements</b>		
4.	<p>The Bidder shall have positive net worth for each of the last three financial years. The Net worth of the Bidder should be at least [30]% of the estimated Project cost in any of the last three Financial Years</p> <p><b><u>Or</u></b></p> <p>Bidder shall have a minimum ACI of [30]% of the estimated Project cost at the close of the preceding financial year</p> <p><i>[Net Worth means sum total of the paid up capital and free reserves (excluding reserves created out of revaluation) reduced by aggregate value of accumulated losses (including debit balance in profit and loss account for current year) and intangible assets.]</i></p> <p><i>[ACI means minimum investible funds (i.e.,</i></p>	<p>Audited Annual financial statements, Balance Sheet and P&amp;L Account for the respective Financial Years as per the format prescribed in Form 12 given in Section 4</p>

S. No.	Requirements	Supporting Documents
	<p><i>immediately available funds for investment and callable capital) subject to the limits of investment in a single investee entity (in the relevant jurisdiction for a Foreign Investment Fund, or the maximum permissible investment limit for an AIF) (as per the SEBI (AIF) Regulations, 2012, as may be amended from time to time), as applicable].</i></p> <p>Please note:</p> <ol style="list-style-type: none"> <li>In case a Bidder and/(or) it's Parent(s)/ Affiliate(s) has issued any fresh equity capital during the current financial year, the same shall be permitted to be added to the Bidder's Net Worth subject to the statutory auditor of the Bidder certifying to this effect.</li> <li>In case a Bidder and/(or) it's parent(s)/ Affiliate(s), being a SEBI registered AIF or Foreign Investment Fund, has received any fresh capital commitment available for the immediate deployment during the current financial year, the same shall be permitted to be added to the Bidder's ACI subject to the statutory auditor of the Bidder certifying to this effect.</li> </ol> <p><b>Project Cost as per EXHIBIT-4</b></p>	

8.2 The Sole/ Lead Bidder would have to clearly include and mention the details of all the solution / component providers given below. However, such solution / component providers may or may not necessarily be included as a part of the Bidding Consortium. For avoidance of doubt, it is clarified that the sole bidder/ any member of the bidding consortium can also be a solution/ component provider, provided that they meet the relevant qualification requirements as mentioned below. The Sole / lead bidder has to mandatorily mention at least one vendor for each of the solution/ component providers given below in Form 1 of section 4:

- Smart Meter Manufacturer(s)
- Head End System (HES) solution provider
- Meter Data Management System (MDMS) solution provider
- System Integrator
- RF Communication Provider (if applicable)

Accordingly, in addition to the requirements provided in 8.1, the various solution / component providers should also separately meet the following requirements as on date of bid submission or as on date of replacement of solution/ component provider post award of contract, subject to necessary approval in writing from the **MVVNL**. Each of the solution / component providers shall sign an agreement with the sole/ lead bidder, provided the solution/ component provider is not the sole/ lead bidder, in the format as specified in Form 23 of section 4, clearly mentioning:

- a) their intent to comply with the terms and conditions of the AMISP Contract in the event the solution/ component provider is selected to undertake the Project
- b) their willingness to work with the said sole/ lead bidder; and
- c) their proposed roles and responsibilities.

S. No.	Requirements	Supporting Documents
<b>A. Meter Manufacturer – Technical Requirements</b>		
A1.	<p><b>Option 1:</b> Should have manufactured and supplied minimum [1,00,000] nos. of Smart meters (cumulative) on proposed communication technology in Indian/Global Power Distribution Utility in the last 7 (seven) years.</p> <p><b>Option 2:</b> Should have manufactured and supplied minimum [20,00,000] nos. of static electricity meters (cumulative) in Indian/Global Power Distribution Utility in the last 7 (seven) years.</p> <p><b>Option 3:</b> Any meter manufacturer who doesn't satisfy Option 1 &amp; 2 but satisfies conditions (A2), (A3) &amp; (A4) below, can also be eligible to participate in the bid as a meter manufacturer. However, meters procured for this tender from this particular meter manufacturer/ supplier, shall be limited to [25%] of the total meters proposed to be implemented as part of this tender.</p>	<p>a) References along with requisite contract/ Purchase Order (PO)/ Work Order (WO). The references should indicate client name, scope of work, Project start date (as per the format prescribed in Form 13);</p> <p>b) Documentary evidence of completion of the Project or other documentary evidence indicating completion of supply (e.g. proof of payment received/ proof of asset capitalized in books of accounts (as applicable) and client certificate for supply of material or similar proofs) along with contact details of the client;</p> <p>c) Client certificate and other documentation for implementation performance/ operation</p>
A2.	Smart meters shall have all the valid test certificate (issued within the last 5 years) and BIS certificate, compliant to IS 16444	Valid BIS and type-test certificate to be submitted



S. No.	Requirements	Supporting Documents
	<p>Part-1*</p> <p><i>Note: *At the time of supply of LT-CT operated Meters, the smart meters shall have all the valid test certificate and BIS Certificate, compliant to IS 16444 Part-2.</i></p>	
A3.	Should have in-house NABL or ISO/ IEC - 17025 accredited Laboratory	A valid registration certificate mentioning issue/renewal/expiry date.
A4.	Should have a valid ISO 9001:2015 certification	Copy of valid certificate
<b>B. Head End System (HES) solution provider – Technical Requirements</b>		
B1.	The HES solution should have been successfully integrated with at least 2 (two) different MDMS/ other utility IT Solution in Indian/ Global Utility(ies) (power/ water/ natural gas/ telecom) in last 7 (seven) years which are in operation for at least 1(one) year.	<p>Certificate / report issued by Client / MDMS OEM / solution provider.</p> <p><i>In case the HES solution provider, has integrated with their own MDMS, then a self-certification shall be provided.</i></p>
<b>C. Meter Data Management System (MDMS) solution provider – Technical Requirements</b>		
C1.	The proposed MDM solution should have been successfully integrated with at least 2 (two) nos. of different HES solutions in Indian/ Global Utility(ies) (power/ water/ natural gas/ telecom) in last 7 (seven) years which are in operation for at least 1(one) year.	a) References along with requisite contract/ Purchase Order (PO)/ Work Order (WO). The references should indicate client name, scope of work, Project start date (as per the format prescribed in Form 13 given in Section 4);
C2.	The proposed MDM solution should have been successfully integrated with at least 2 (two) nos. of different Billing Systems in Indian/ Global Utility(ies) (power/ water/ natural gas/ telecom) or with Billing/ Other IT systems of 2 (two) different Indian/ Global Utility(ies) in last 7 (seven) years which are in operation for at least 1(one) year.	b) Documentary evidence of completion of the Project or completion of Go-live status (i.e., Go-live certificate, UAT testing certificate etc.) of the respective project as per the definition of Go-Live/ UAT specified therein or other documentary evidence indicating completion (e.g., proof of payment received/ proof of asset capitalized in books of accounts (as

S. No.	Requirements	Supporting Documents
		<p>applicable) and client certificate for supply of material or similar proofs) along with contact details of the client</p> <p>c) Certificate / report issued by Client / HES OEM/ solution provider. <i>In case the MDMS solution provider, has integrated with their own HES, then a self-certification shall be provided.</i></p> <p>d) Client certificate and other documentation for implementation performance/ operation.</p>
C3.	Should have CMMi (Capability Maturity Model Integration) Level 3 or IEC/ISO 27001 Certification (Software Development & Customization), as the requirement may be	Copy of valid certificate
<b>D. System Integrator – Technical Requirements</b>		
D1.	Should have experience of integration of HES/MDMS etc. with at least 2 (two) billing / other utility IT systems in Indian/ Global Utility(ies) (power/ water/ natural gas/ telecom) in last 7 (seven) years, in which the meters are in operation for at least 1(one) year.	Certificate / report issued by Client / Billing system solution provider.
D2.	<ul style="list-style-type: none"> <li>Should have valid ISO 9001:2015 certification</li> <li>Should have IEC/ ISO 27001 certification or CMMi Level 3 (or above) certifications</li> </ul>	Copy of valid certificate
<b>E. RF Technology Solution Provider – Technical Requirements (If applicable)</b>		
E1.	The Proposed RF technology by the RF Solution provider should have been implemented in project/(s) with at least [50,000] (cumulatively) modules / endpoints involving Radio Frequency (RF) mesh in an Indian/ Global Utility (power/ water/ natural gas/ telecom) in the last 7 (seven) years which are in operation for at least 1 (one) year.	a) References along with requisite contract/ Purchase Order (PO)/ Work Order (WO). The references should indicate client name, scope of work, Project start date (as per the format prescribed in Form 13 given in Section 4);



## Section 2. Eligibility Requirements

S. No.	Requirements	Supporting Documents
		<p>b) Documentary evidence of completion of the Project or completion of Go-live status (i.e., Go-live certificate, UAT testing certificate etc.) of the respective project as per the definition of Go-Live/ UAT specified therein or other documentary evidence indicating completion (e.g., proof of payment received/ proof of asset capitalized in books of accounts (as applicable) and client certificate for supply of material or similar proofs) along with contact details of the client;</p> <p>c) Client certificate and other documentation for implementation performance/ operation.</p>
E2.	<p>The RF Solution provider should have been in the communications network installation / maintenance services business for the last 1 (one) year in India.</p> <p>OR</p> <p>The RF Solution provider should have been in the communications network installation / maintenance services business for the last 3 (three) years outside of India.</p>	<p>a) Certificate of Incorporation and Registration certificate along with Memorandum &amp; Articles of Association.</p> <p>b) Copy of valid Licenses (In case of RF, Valid certificate issued by Wireless Planning &amp; Coordination (WPC) Wing of the Ministry of Communications, GOI)</p>
E3.	The RF Solution provider have successfully integrated their NIC/ Communication module with at least 3 (three) different makes of smart meters in India.	Signed agreements/ MoUs for integration of NIC module or Certificate of successful integration.

**8.3.** For the purposes of satisfaction of Technical Requirement, the following shall apply:

- a) Eligible Projects, as referred in Technical Requirement, shall mean works contracts for developing asset/ facility in India or abroad which involve building/ installing, and commissioning/ go-live such asset/ facility but shall not include any assignment where the scope is limited to only (i) supply of goods or (ii) supply of manpower.

- 
- b) Projects that have achieved completion/ or have achieved commissioning/ go-live as identified in the Project document(s) at least 7 (seven) Days prior to the Bid Submission Deadline shall be considered.
  - c) The Technically Evaluated Entity must have either executed itself/ paid for such projects or must own at least 26% of the shareholding in the company that has executed the project(s) up to the date of commissioning of such project.
  - d) For the purpose of clause, 8.1 above, Infrastructure sector is defined under Definitions in Section 3. In reference to this, Energy efficiency projects in Electricity distribution sector shall also be considered.
  - e) For the purpose of clause, 8.1 & 8.2 (A) to (E) above, the Eligible Project(s) in the:
    - i. Power sector shall mean projects relating to generation or transmission or distribution of electricity;
    - ii. Water sector shall mean projects relating to water treatment including desalination or water supply (rural or urban) or wastewater / sewerage or drainage or water pipelines;
    - iii. Natural gas sector shall mean projects relating to natural gas transmission or distribution; and
    - iv. Telecom sector shall mean projects relating to infrastructure cabling or communication systems for setting up Wide Area Network (WAN) or Local Area Network (LAN) or Internet Services or VOIP solutions, etc.

**8.4.** For the purposes of satisfaction of Financial Requirement, the following shall apply:

- a) In the event Bidder is a Consortium, the financial requirement shall be met individually and collectively by all the Members in the Bidding Consortium. The financial requirement to be met by each Member of the Bidding Consortium shall be as detailed below:
  - (i) The Lead Consortium Member/ Lead Bidder shall meet not less than 51% of the minimum financial requirement criteria given at clause no.8.1 (3) above.
  - (ii) and each of the other Consortium Member(s) individually shall meet not less than 5% of the minimum financial requirement criteria given at clause no. 8.1 (3) above.

## Section – 3: Instructions to Bidders and Bid Data Sheet

### TABLE OF CONTENT

<b>A. General Provisions.....</b>	<b>29</b>
1. Definitions .....	29
2. Introduction .....	33
3. Conflict of Interest .....	35
4. Bidders to Inform Itself Fully .....	36
5. Fraud and Corruption .....	37
6. Eligibility and Qualification Requirements.....	37
<b>B. Preparation of Proposals .....</b>	<b>37</b>
7. General Considerations and Instructions .....	37
8. Cost of Bidding / Preparation of Proposal .....	39
9. Language .....	39
10. Documents Comprising the Proposal and List of Forms .....	39
11. Only One Proposal.....	39
12. Proposal / Bid Validity & Bid Security .....	39
13. Clarification and Amendment of RFP .....	41
14. Preparation of Bid/ Proposal and Bid Formats.....	42
15. Technical Bid/ Proposal Format and Content .....	42
16. Financial Bid/ Proposal Format and Content .....	46
<b>C. Submission, Opening and Evaluation .....</b>	<b>47</b>
17. Submission of Bids/ Proposals and Bid Submission Deadline .....	47
18. Confidentiality .....	49
19. Opening of Technical Bids/ Proposals.....	49
20. Bid/ Proposals Evaluation Overview and Verification/ Clarifications .....	50
21. Evaluation of Technical Bids/ Proposals .....	51
22. Opening of Financial Proposals.....	52
23. Evaluation of Financial Bids/ Proposals .....	52
24. Deviations, Reservations and Omissions .....	52
<b>D. Award of Contract.....</b>	<b>53</b>
27. <b>MVVNL</b> 's Right to Vary Quantities at the time of Award.....	54
28. Letter of Award.....	54
29. Signing of Contract and Contract Performance Security.....	54

<b>E. Bid Data Sheet.....</b>	<b>57</b>
<b>Annexure I (BDS) .....</b>	<b>67</b>
<b>Checklist of Required Forms .....</b>	<b>69</b>
<b>PART II .....</b>	<b>349</b>
<b>A. Form of Contract .....</b>	<b>352</b>
<b>B. Form of Contract .....</b>	<b>355</b>
<b>II. General Conditions of Contract.....</b>	<b>359</b>
<b>PART III.....</b>	<b>411</b>
<b>Contract Related Forms.....</b>	<b>411</b>

---

## Instructions to Bidder

### A. General Provisions

<p><b>1. Definitions</b></p>	<p><b>1.1 Definitions</b></p> <p>(a) <b>“Affiliate”</b> shall mean a company or AIF or Foreign Investment Fund that either directly or indirectly: controls or is controlled by or is under common control with a Bidder and “control” mean either (i) ownership by one company or AIF or Foreign Investment Fund of 26% of the voting rights of the other company or AIF or Foreign Investment Fund, as the case may be or (ii) an AIF or Foreign Investment Fund that has the power to direct the management and policies by operation of law or contract;</p> <p>(b) <b>“Alternative Investment Fund” or “AIF”</b> shall have the meaning as ascribed to the term ‘alternative investment fund’ under Regulation 2(1)(b) of the Securities and Exchange Board of India (Alternative Investment Funds) Regulations, 2012 (as may be amended from time to time)</p> <p>(c) <b>“ACI”</b> shall mean minimum investible funds (i.e. immediately available funds for investment and callable capital, net of estimated expenditure for administration and management of the fund) subject to the limits of investment in a single investee entity (in the relevant jurisdiction for a Foreign Investment Fund, or the maximum permissible investment limit for an AIF) (as per the Securities and Exchange Board of India (Alternative Investment Funds) Regulations, 2012, as may be amended from time to time). In case of an AIF or Foreign Investment Fund using ACI, ACI would be considered as per the certificate issued by statutory auditor (or such other certificate as filed with the regulator in the relevant jurisdiction) not older than 1 (one) months prior to the date of Bid Submission;</p> <p>(d) <b>“AMISP Service Charge”</b> shall mean the payment to be made by the <b>MVVNL</b> to the AMISP in INR per meter per month for each category of meter as quoted in the Bid;</p> <p>(e) <b>“AMISP Contract” or “Contract”</b> shall mean the Contract to be entered into between the Selected Bidder in the event the Selected Bidder is an individual entity, Lead Bidder in the event the Selected Bidder is a Consortium and <i>the SPV, incorporated by the Selected Bidder in the event formation of SPV is mandatory/ opted and permitted as per <b>Bid Data Sheet</b><sup>1</sup> and the <b>MVVNL</b>, for undertaking the Project;</i></p>
------------------------------	---

<sup>1</sup> Lead Bidder in the event the Selected Bidder is a Consortium

	<p>(f) <b>“Bid”</b> shall mean the bid submitted by a Bidder(s) in response to this RFP and shall include the Technical Bid and the Financial Bid;</p> <p>(g) <b>“Bidder(s)”</b> shall mean individual entity or Consortium of entities bidding in response to this RFP. The Bidder can either be a company incorporated under the applicable laws of their relevant jurisdiction or an AIF or a Foreign Investment Fund;</p> <p>(h) <b>“Bidding Consortium”</b> shall mean the Consortium of entities bidding for Project after executing Consortium Agreement as per the terms and conditions of this RFP;</p> <p>(i) <b>“Bid Data Sheet (BDS)”</b> means an integral part of the <b>Instructions to Bidders (ITB) Section 3</b>, that is used to reflect issues, details and conditions specific to the procurement, to supplement and/or modify the provisions of ITB.</p> <p>(j) <b>“Bid Submission Deadline”</b> shall have the meaning as ascribed thereto in <b>ITB 17.5</b>;</p> <p>(k) <b>“Conflict of Interest”</b> shall have the meaning as ascribed thereto in <b>ITB 3</b>;</p> <p>(l) <b>“Consortium Member”</b> shall mean any Member of the Bidding Consortium other than the Lead Consortium Member;</p> <p>(m) <b>“Contractor”</b> shall mean the same as <b>“AMISP”</b>;</p> <p>(n) <b>“Contract Price”</b> shall have the meaning as ascribed thereto in Section 7;</p> <p>(o) <b>“Day”</b> means a calendar day, unless otherwise specified as <b>“Business Day”</b>. A Business Day is any day that is an official working day of <b>MVVNL</b>. It excludes <b>MVVNL</b>'s official public holidays.</p> <p>(p) <b>“Financial Bid”</b> shall have the meaning as ascribed thereto in <b>ITB 16</b>;</p> <p>(q) <b>“Financially Evaluated Entity”</b> shall mean the company which has been evaluated for the satisfaction of the financial requirement set forth in Clause 8 of Section 2;</p> <p>(r) <b>“Financial Proposal”</b> shall mean the same as Financial Bid;</p> <p>(s) <b>“Financial Year” or “FY”</b> shall mean the period starting from 1st April of a calendar year to 31st March of the consecutive calendar year;</p> <p>(t) <b>“Foreign Investment Fund”</b> shall mean any pooled investment vehicle or investment fund which is registered or recognized with a securities market/banking regulator of a “foreign</p>
--	--

	<p>jurisdiction”;</p> <p>(u) <b>“Foreign Jurisdiction”</b> means a country, other than India, whose securities market regulator is a signatory to International Organization of Securities Commission’s Multilateral Memorandum of Understanding (IOSCO’s MMOU) or a signatory to bilateral Memorandum of Understanding with the Securities and Exchange Board of India, and which is not identified in the public statement of Financial Action Task Force as a jurisdiction having a strategic Anti-Money Laundering or Combating the Financing of Terrorism deficiencies to which counter measures apply or a jurisdiction that has not made sufficient progress in addressing the deficiencies or has not committed to an action plan developed with the Financial Action Task Force to address the deficiencies and are allowed to make investment India in terms of applicable law;</p> <p>(v) <b>“ITB”</b> (this Section 3 of the RFP) means the Instructions to Bidders that, along with other Sections, provides the Bidders with all information needed to prepare their Proposals.</p> <p>(w) <b>“Lead Consortium Member” or “Lead Bidder”</b> shall mean the Member of the Bidding Consortium, designated as such by the other members of the Consortium, having authority to represent all the members before the <b>MVVNL</b>;</p> <p>(x) <b>“Meter-months”</b>: At any point of time, meter-months of the AMI system is calculated as the sum of number of months from operationalization of the meter or Operational Go-Live, whichever is later, for all meters installed and commissioned by the AMISP, taking into account all Change Orders issued by the <b>MVVNL</b>;</p> <p>(y) <b>“Month”</b> shall mean calendar months unless otherwise specified.</p> <p>(z) <b>“Operational Go-live”</b> shall have the meaning as ascribed thereto in Clause 9.6 of Section 6 of the RFP Document;</p> <p>(aa) <b>“Parent(s)”</b> shall mean an entity that is either (i) a Company or an AIF or a Foreign Investment Fund that holds at least twenty six percent (26%) of the paid - up equity capital directly or indirectly in the Bidder, as the case may be; or (ii) an AIF or Foreign Investment Fund that has the power to direct the management and policies by operation of law or contract;</p> <p>(bb) <b>“Project”</b> shall mean the <b>MVVNL</b>’s AMI Project defined in Clause 1 of Section 6 of the RFP Document;</p> <p>(cc) <b>“Proposal”</b> shall mean the same as Bid and shall include the Technical Proposal and the Financial Proposal;</p>
--	---

	<p>(dd) <b>“Request for Proposal” or “RFP”</b> means this Tender of which the number, name and details have been mentioned in <b>Bid Data Sheet</b>, including all its Volumes/ Sections/ Forms/ Annexures/ Appendices etc., for Appointment of AMISP (including all clarification/ addendum/ amendment/ corrigendum/ etc. issued from time to time);</p> <p>(ee) <b>“RFP Document”</b> shall have the same meaning as ascribed thereto in ITB 2.1 and ITB 2.1.1</p> <p>(ff) <b>“Service(s)” or “Related Service(s)”</b> shall mean any Service(s) performed or to be performed as a part of the Project by the AMISP;</p> <p>(gg) <b>“Special Purpose Vehicle” or “SPV”</b> shall mean a company incorporated under Companies Act, 2013 for the purpose of executing the Project as set out in in Clause 1 of Section 6;</p> <p>(hh) <b>“Sub-Contractor”</b> shall mean any person, natural or legal, including manufacturers, to whom execution of any part of the AMISP Contract, including preparation of any design or supply of the AMI Project, is sub-contracted directly or indirectly by the Contractor, and includes its legal successors or permitted assigns;</p> <p>(ii) <b>“Technical Bid”</b> shall have the meaning as ascribed thereto in <b>ITB 15</b>;</p> <p>(jj) <b>“Technical Proposal”</b> shall mean the same as Technical Bid;</p> <p>(kk) <b>“Technically Evaluated Entity”</b> shall mean the company which has been evaluated for the satisfaction of the technical requirement set forth in Clause 8 of Section 2;</p> <p>(ll) <b>“Tender”</b> shall mean the same as “RFP”;</p> <p>(mm) <b>“Tender Fee”</b> shall mean the fees submitted with the RFP;</p> <p>(nn) <b>“Total Meter-months”</b>: Total Meter-months of the AMI system is calculated as the product of total number of smart meters installed, integrated and operationalized in the Project (by taking into account all Change Orders issued by the <b>MVVNL</b>) and 90 (ninety) months commencing post Operational Go-Live.</p> <p>(oo) <b>“MVVNL”</b> means the entity, named, and as briefly described in <b>Bid Data Sheet</b>, that has issued the Request for Bids for Appointment of Advanced Metering Infrastructure (AMI) Service Provider for Smart Prepaid Metering in India on Design Build Finance Own Operate Transfer (DBFOOT basis), to enter into a Contract for Design Build Finance Own Operate Transfer (DBFOOT) AMI system in the Project area as per the RFP</p>
--	--



	<p>Document.</p> <p>(pp) "<b>Ultimate Parent Company</b>" shall mean an entity which owns at least twenty six percent (26%) equity in the Sole Bidder or Member of a Consortium, (as the case may be) and in the Technically Evaluated Entity and/or Financially Evaluated Entity (as the case may be) and such Sole Bidder or Member of a Consortium, (as the case may be) and the Technically Evaluated Entity and/or Financially Evaluated Entity (as the case may be) shall be under the direct control or indirectly under the common control of such entity.</p> <p>(qq) "<b>Infrastructure sector</b>" shall mean such sectors notified by Department of Economic Affairs in its Gazette Notification no. 13/1/2017-INF dated 26<sup>th</sup> April 2021 and as amended from time to time.</p> <p>1.1.1 Capitalised terms used herein but not defined specifically shall have the meaning as ascribed to them in Section 5 and Section 6, and elsewhere in RFP Document.</p> <p>1.2 <b>Singular and Plural:</b> Where the context so requires, words imparting the singular only also include the plural and vice versa.</p> <p>1.3 <b>Headings and Marginal Notes:</b> Headings and marginal notes to the terms and conditions of the Contract are not deemed to form part thereof nor are to be taken into consideration in the interpretation or construction thereof or of the Contract.</p>
<p><b>2. Introduction</b> <b>(a) About this Request for Proposal</b></p>	<p>2.1 This Request for Proposal (RFP) is issued by the <b>MVVNL</b> for selecting the AMISP to implement <b>MVVNL</b> 's AMI Project. This RFP Document provides the overall structure of the document (as outlined in the beginning of the document in the section titled "Summary, Abbreviations &amp; Table of Content"), requirements and general terms and conditions applicable to each Bidder</p> <p>2.1.1 The RFP Document (also referred to as the bidding document) consist of Parts I, II, and III, which include all the sections indicated below, and should be read in conjunction with any Addenda/ Corrigenda/ Amendments/ Clarifications etc. issued thereto from time to time in accordance with this Section 3.</p> <p><b>PART I Bidding Procedures and Requirements</b></p> <ul style="list-style-type: none"> <li>● Section 1 - Request for Proposal Notice</li> <li>● Section 2 - Eligibility Requirements</li> <li>● Section 3 - Instructions to Bidders and Bid Data Sheet</li> <li>● Section 4 - Bidding Forms - Technical Proposal</li> <li>● Section 5- Bidding Forms - Financial Proposal</li> </ul>

<p><b>(b) Bidding Process and Electronic-Procurement System</b></p>	<ul style="list-style-type: none"> <li>• Section 6 - Project Requirements</li> </ul> <p><b>PART II Contract Form and Conditions of Contract</b></p> <ul style="list-style-type: none"> <li>• Section 7 – Contract Form and Conditions of Contract</li> </ul> <p><b>PART III Contract Related Forms</b></p> <ul style="list-style-type: none"> <li>• Section 8 – Contract Related Forms</li> </ul> <p>2.2 Bidding against the Request for Proposal shall be under Two Envelope Single Stage Bidding Process. The bidding process will be conducted online with Electronic – Procurement System (e-Procurement/ e- Tendering/ e- Bidding System) as specified in <b>BDS</b>.</p> <p>2.2.1 The Bidders who wish to participate in online Tenders will have to procure/ should have legally valid digital signature as per Information Technology Act, 2000 using which they can sign their electronic Bids.</p> <p>2.2.2 All Bids should be digitally signed. For details regarding digital signature certificate and related training, the Bidder should contact at the address mentioned in <b>BDS</b>.</p>
<p><b>(c) Study of <b>MVVNL</b>'s Existing Systems</b></p>	<p>2.3 The Bidders are invited to submit their Proposal comprising a Technical Proposal and a Financial Proposal, for award of Contract named in the <b>BDS</b>. The Proposal will be the basis for evaluation and holding discussions, if required, and ultimately signing the Contract with the Selected Bidder.</p> <p>2.4 A standard brief regarding detail of existing systems relevant to the AMI Project has been provided in <b>BDS</b>. However, notwithstanding the same, all Bidders are advised to visit and examine the site and existing facilities, and obtain for itself, on its own responsibility and cost, all information that may be necessary for preparing the Bid. The cost of visiting the site shall be at the Bidder's own expense.</p> <p>2.5 The Bidder and any of its personnel or agents shall be granted permission, through the assistance of the <b>MVVNL</b>, by the <b>MVVNL</b> to enter upon its premises and lands for the purpose of such inspection, but only upon the express condition that the Bidder, its personnel and agents will release and indemnify the <b>MVVNL</b> and its personnel and agents from and against all liability in respect thereof and will be responsible for death or personal injury, loss of/or damage to property and any other loss, damage, costs and expenses incurred as a result of the inspection.</p> <p>2.6 <del>The Bidder's designated representative(s) is/are invited to attend a pre bid meeting at Bidder's expense, which shall take place at the time and venue specified in the <b>BDS</b></del></p>
<p><b>(d) Pre-Bid Meeting</b></p>	<p>2.7 <del>The purpose of the meeting will be to clarify any issues regarding this RFP in general and the scope of work in particular.</del></p>

	<p>2.8 The Bidder may submit any question or query to <b>MVVNL</b> in writing, on email, to reach <b>MVVNL</b> not later than one week after issue of this RFP <del>before the meeting</del> as per the format given in <b>BDS</b>. It may not be practicable <del>at the meeting</del> to answer questions received <del>late</del>, but questions and responses will be transmitted as indicated hereafter.</p> <p>2.9 <del>Minutes of the meeting, including the text of the questions raised and the responses given, together with any responses prepared after the meeting,</del> The <b>MVVNL</b> will provide a collective response and same will be transmitted through the e-Procurement System mentioned in ITB 2.2 without delay on e-tender website for benefit of all prospective Bidders who have downloaded the RFP.</p> <p>2.10 <del>Non attendance at the pre bid meeting will not be a cause for disqualification of a Bidder</del></p>
<p><b>3. Conflict of Interest</b></p>	<p>3.1 A Bidder shall not have a conflict of interest that affects the Bidding process (the “<b>Conflict of Interest</b>”). In the event a Bidder is found to have a Conflict of Interest, the <b>MVVNL</b> may choose to reject the Bid, terminate the AMISP Contract (in the event it has been awarded) as per termination clause in the AMISP Contract. Any Bidder found to have a Conflict of Interest shall be disqualified.</p> <p>3.2 A Bidder shall be deemed to have a Conflict of Interest affecting the bidding process, if:</p> <p>(a) the Bidder or its Member (or any constituent thereof) and any other Bidder or its Member (or any constituent thereof) have common controlling shareholders or other ownership interest;</p> <p>Provided that this disqualification shall not apply in cases where the direct or indirect shareholding of a Bidder or its Member (or any shareholder thereof having a shareholding of more than 15% (fifteen per cent) of the paid up and subscribed share capital of such Bidder or its Member, as the case may be) in the other Bidder or its Member, is less than 15% (fifteen per cent) of the subscribed and paid-up equity share capital thereof;</p> <p>Provided further that this disqualification shall not apply to any ownership by a bank, insurance company, pension fund or a public financial institution referred to in sub-section (72) of section 2 of the Companies Act, 2013.</p> <p>For the purposes of this Clause, indirect shareholding held through one or more intermediate persons shall be computed as</p>

	<p>follows: (i) where any intermediary is controlled by a person through management control or otherwise, the entire shareholding held by such controlled intermediary in any other person (the “Subject Person”) shall be taken into account for computing the shareholding of such controlling person in the Subject Person; and (ii) subject always to sub-clause (a) above, where a person does not exercise control over an intermediary, which has shareholding in the Subject Person, the computation of indirect shareholding of such person in the Subject Person shall be undertaken on a proportionate basis; provided, however, that no such shareholding shall be reckoned under sub-clause (ii) if the shareholding of such person in the intermediary is less than 26% of the subscribed and paid up equity shareholding of such intermediary; or</p> <p>(b) a constituent of such Bidder is also a constituent of another Bidder; or</p> <p>(c) such Bidder or its Member thereof receives or has received any direct or indirect subsidy, grant, concessional loan or subordinated debt from any other Bidder or its Member, has provided any such subsidy, grant, concessional loan or subordinated debt to any other Bidder or its Member; or</p> <p>(d) such Bidder has the same legal representative for purposes of this Bid as any other Bidder; or</p> <p>(e) such Bidder, has a relationship with another Bidder, directly or through common third party/ parties, that puts either or both of them in a position to have access to each other’s information about, or to influence the Bid of either or each other; or</p> <p>(f) such Bidder has participated as a consultant to the Authority in the preparation of any documents, design, or technical specifications of the Project.</p> <p><i>Explanation: In case a Bidder is a Consortium, then the term Bidder as used in this Clause shall include each Member of such Consortium.</i></p>
<p><b>4. Bidders to Inform Itself Fully</b></p>	<p>4.1 The Bidder shall make independent enquiry and satisfy itself with respect to all the required information, inputs, conditions (including site conditions) and circumstances and factors that may have any effect on its Bid. Once the Bidder has submitted the Bid, the Bidder shall be deemed to have examined the laws and regulations in force, and fixed its price taking into account all such relevant conditions and also the risks, contingencies and other circumstances which may influence or affect the Services performed within the scope of work, as provided in this RFP. Accordingly, the Bidder acknowledges that, on being selected, it</p>

	<p>shall not be relieved from any of its obligations under the RFP Documents nor shall be entitled to any extension of time for commencement of Services or financial compensation for any reasons whatsoever attributable to AMISP.</p> <p>4.2 The Bidders should particularly acquaint themselves with the technical requirements of <b>MVVNL</b>'s systems, operations, assets, equipment, statutory codes, and standards.</p> <p>4.3 The Bidder shall familiarize itself with the procedures and time frames required to obtain all consents, clearances and permits required for implementation of the Project</p>
<b>5. Fraud and Corruption</b>	5.1 <b>MVVNL</b> requires compliance with the Anti-Corruption Guidelines/ Laws in force of the relevant Government/ its instrumentalities/ <b>MVVNL</b> .
<b>6. Eligibility and Qualification Requirements</b>	6.1 The eligibility and qualification requirements for submission of Proposals against the RFP are given in Section 2. Proposals, if any, from Bidders not complying with the same shall be outrightly rejected and shall not be considered for evaluation.
<b>B. Preparation of Proposals</b>	
<b>7. General Considerations and Instructions</b>	<p>7.1 In preparing the Proposal, the Bidder is expected to examine the RFP Document in detail. Material deficiencies in providing the information or documentation requested in the RFP Document may result in rejection of the Proposal.</p> <p>7.2 All Bidders shall comply with the dates and amounts indicated in <b>Section 1</b> of this RFP.</p> <p>7.3 The Bidders shall comply with and agree to all the provisions of this RFP for various bidding considerations including but not limited to eligibility, costs, payments, information regarding <b>MVVNL</b>'s systems, bid formats, Bid submission and other considerations.</p> <p>7.4 The Bidders shall be evaluated based on the requirements, criteria, norms, and procedures laid out or included by reference, in this <b>Section 3</b> of the RFP Document.</p> <p>7.5 The Bidders shall be required to undertake the scope of work for the Project indicated in <b>Section 6</b> of the RFP Document.</p> <p>7.6 The Bidders must conform to the requirements and provide a list of equipment (including any special equipment) necessary to meet the technical specifications, functional &amp; performance requirements as specified in the Section 6 of RFP Document as per the format provided in Form 14 in Section 4. The equipment supplied shall conform to all the requirements under all applicable laws including any order issued by the central</p>

	<p>government including Order No No.9/16/2016-Trans-Part (2) dated 18 November 2020, Order No. F/No.6/18/2019-PPD by Ministry of Finance, Department of Expenditure, Public Procurement Division dated 23 July 2020, latest Government of India Guidelines for Make in India, Domestically manufactured products, Atmanirbhar Bharat and circulars DIPP Office Memorandum No. P-45021/2/2017-PP (BE-II) date:16th Sept. 2020, MeitY Circular No.1(10)/2017-CLES dated 06.12.2019 and Order No. 11/05/2018-Coord. by the Ministry of Power dated 17 September 2020 including any amendments or modifications to the same from time to time.</p> <p>7.7 Bidder shall submit ‘Clause by Clause’ compliance to the RFP document including the AMISP Contract and the technical specifications and functional requirements (with amendments, if any) as per the format prescribed in <b>Form 15</b> given in Section 4.</p> <p>7.8 Bidder’s Proposal shall include sufficient information and supporting documentation in order to determine compliance without further necessity for inquiries.</p> <p>7.9 The Bidder’s Proposal shall clearly identify all features described in the specifications along with any supporting reference material in accordance with ITB 15.13 as per the format prescribed in <b>Form 3</b> given in Section 4.</p> <p>7.10 An analysis of the technical specifications, functional and performance requirements of the AMI system as provided in Section 6 may lead the Bidders to conclude that additional items (for example communication repeater, router etc.) are required that are not specifically mentioned in this specification. The Bidders shall be responsible for installing such items (at no additional cost to the <b>MVVNL</b>) such that a reliable and fully functional AMI system is implemented that meets or exceed the capacity and performance requirements. Such materials shall be deemed to be within the scope of the AMISP Contract. To the extent possible, the Bidder shall identify and include all such additional items in their proposal.</p> <p>7.11 The Bidders are advised to visit sites (at their own expense), prior to the submission of the proposal, and make surveys and assessments as deemed necessary for proposal submission.</p> <p>7.12 Failure by <b>MVVNL</b> to require information from a Bidder that has not been properly provided shall not be construed as waiver on the part of <b>MVVNL</b> of the obligation of the Bidder to furnish the said data / information unless the waiver is in writing.</p> <p>7.13 Bid submitted by the Bidders before the Bid Submission Deadline, shall become the property of the <b>MVVNL</b> and shall not be returned to the Bidders.</p> <p>7.14 The cost of all stamp duties payable for executing the RFP, Bid Documents or Project shall be borne by the Bidders.</p>
--	---

	7.15 No interest shall be paid to the Bidder on any amount submitted to <b>MVVNL</b> , whether to be returned or not.
<b>8. Cost of Bidding / Preparation of Proposal</b>	8.1 The Bidder shall bear all costs associated with the preparation and submission of its Proposal, including post-bid discussions, technical and other presentations etc., and <b>MVVNL</b> shall not be responsible or liable for those costs, regardless of the conduct or outcome of the selection process. <b>MVVNL</b> is not bound to accept any proposal and reserves the right to annul the selection process at any time prior to Contract award, without thereby incurring any liability to the Bidder.
<b>9. Language</b>	9.1 Bid/Proposal prepared by the Bidders and all correspondence and documents relating to the Bid exchanged by the Bidder and <b>MVVNL</b> and its associates shall be written in the English language.
<b>10. Documents Comprising the Proposal and List of Forms</b>	10.1 The Proposal shall comprise the documents and forms mentioned in this Section in general and listed in <b>Section 4</b> and <b>Section 5</b> in particular. A Document Checklist for the same as well as the list of forms referred to in this RFP Document is provided in <b>BDS</b> .
<b>11. Only One Proposal</b>	11.1 A Bidder shall submit only one Bid in the same bidding process, either individually as a Sole Bidder or as a Lead Member of a Bidding Consortium. Any member of the bidding consortium, including its Parent(s) and/or Affiliate(s), whose technical and financial capabilities are showcased for meeting the criteria as mentioned in Clause 8.1 of Section 2, shall not separately participate directly or indirectly in another bid in the same bidding process for meeting the criteria as mentioned in Clause 8.1 of section 2.
<b>12. Proposal / Bid Validity &amp; Bid Security</b>	<p>12.1 The Bid/ Proposal submitted by the Bidder(s) shall be valid for a period of specified in <b>BDS</b> reckoned from the Bid Submission Deadline specified in ITB 17 as may be extended from time to time.</p> <p>12.1.1 All such offers, and terms and conditions set forth in this RFP shall be valid for the AMISP till the successful completion of the Project.</p> <p>12.1.2 In exceptional circumstance, <b>MVVNL</b> may solicit the Bidder's consent to an extension of the Bid validity period. The request and responses thereto shall be made in writing or by email. If a Bidder accepts to extend the validity, the Bid Security shall also be suitably extended. A Bidder may refuse the request without forfeiting its Bid Security. A Bidder granting the request will not be required or permitted to modify its Bid.</p> <p>12.2 The Bidder shall furnish as part of its Technical Bid, a Bid security in original form, and in the amount specified in the</p>



	<p><b>BDS.</b></p> <p>12.3 Pursuant to <b>ITB 12.2</b>, the Bid Security shall be a demand guarantee, and in any of the following forms, at the Bidder's option:</p> <p>(a) an unconditional bank guarantee issued by any of the banks mentioned in <b>BDS</b>;</p> <p>(b) Bid Security in other forms, if specified in the <b>BDS</b>.</p> <p>In the case of a bank guarantee, the Bank Guarantee for Bid Security shall be provided by the Lead Consortium Member/ Sole Bidder in the format prescribed in Form 6 included in <b>Section 4</b>, Bidding Forms - Technical Proposal. The bid security shall be valid for 90 (ninety) Days beyond the end of validity period of the Bid specified in ITB 12.1. This shall also apply if the period of the Bid validity is extended.</p> <p>12.4 Any Bid not accompanied by a substantially responsive Bid Security as specified, shall be rejected by the <b>MVVNL</b> as non-responsive.</p> <p>12.5 If the Bid Security from any Bidder is forfeited or lapsed either partly or wholly during the Bid process, then such Bidders and Consortium are liable for rejection.</p> <p>12.6 Bid Security of unsuccessful Bidders shall be returned as promptly as possible upon the successful bidder's signing the contract and furnishing the Performance Security pursuant to <b>ITB 29</b>.</p> <p>12.7 The Bid Security of the Selected Bidder shall be returned as promptly as possible once the AMISP has signed the Contract with the <b>MVVNL</b> and furnished the required Performance Security.</p> <p>12.8 The Bid Security may be forfeited if</p> <p>12.8.1 The Bidder withdraws/ modifies/ substitutes its Bid during the period of Bid validity as specified in ITB 12.1 or any extension thereto provided by the Bidder;</p> <p>12.8.2 Bid is rejected for existence of conflict of interest, or more than one bid being submitted by a Bidder</p> <p>12.8.3 Bid submitted by a Consortium is not accompanied by Consortium Agreement in the form provided in this RFP.</p> <p>12.8.4 The Selected Bidder:</p> <p>12.8.4.1 Fails to sign the AMISP Contract; or</p> <p>12.8.4.2 Fails to furnish a Performance Security in accordance with ITB 29; or is found to have submitted false particulars/ fake documents; or</p> <p>12.8.4.3 refuses to execute the work at its agreed scope/quoted rates, after <b>MVVNL</b> issues the Letter</p>
--	---



	<p>of Award</p> <p>12.8.4.4 is involved in incidents of manipulation of rates either by cartelization or otherwise.</p>
<b>a. Extension of Proposal Validity</b>	<p>12.9 <b>MVVNL</b> will make its best effort to complete the bidding process and award the contract prior to the date of expiry of the Bid/ Proposal validity. However, should the need arise, <b>MVVNL</b> may request, in writing, all Bidders who submitted Bids/Proposals prior to the Bid Submission Deadline to extend the Proposals' validity.</p> <p>12.10 If the Bidder agrees to extend the validity of its Proposal, it shall be done without any change in the original Proposal.</p> <p>12.11 The Bidder has the right to refuse to extend the validity of its Proposal in which case such Proposal will not be further evaluated.</p>
<b>13. Clarification and Amendment of RFP</b>	<p>13.1 Bidders may seek clarifications on this RFP in writing, through a letter, fax or email to reach <b>MVVNL</b> no later than the period specified in <b>BDS</b>.</p> <p>13.2 <b>MVVNL</b> may issue clarification only, at its sole discretion, which is considered reasonable by it.</p> <p>13.3 Any such clarifications issued shall be sent to all the Bidders to whom the RFP has been issued. Any such clarification shall also be hosted on the website of the <b>MVVNL</b> and transmitted through the e-Procurement System mentioned in ITB 2.1.</p> <p>13.4 <b>MVVNL</b> is not under any obligation to entertain/ respond to suggestions made or to incorporate modifications sought for.</p> <p>13.5 For the avoidance of any doubt, it is hereby clarified that the <b>MVVNL</b> is not obliged to extend the Bid Submission Deadline on account of clarifications sought in accordance to ITB 13.4.</p> <p>13.6 During the bidding process, <b>MVVNL</b>, for any reason may modify the RFP, including the timelines, by issuance of addendum / modification / errata and / or a revised document.</p> <p>13.7 Revisions or amendments in the bidding guidelines may cause <b>MVVNL</b> to modify amend or supplement the RFP to be in conformance with any applicable Law. Such document shall be notified in writing through the e-Procurement System mentioned in ITB 2.1, or letter or fax or e-mail to all the entities who have downloaded the RFP, and the same shall be binding on them.</p> <p>13.8 <b>MVVNL</b> shall not be responsible for any delay in receipt of the addendum/ modification/ errata and/ or revised document and receipt of the same by the Bidders shall be presumed by <b>MVVNL</b> upon taking all reasonable steps to notify the Bidders. Late receipt of any addendum/ modification/ errata</p>

	<p>and/ or revised document will not relieve the Bidder from being bound by that modification or the Bid Submission Deadline. All such amendments/modifications shall be issued at least 7(seven) working days prior to the Bid Submission Deadline.</p> <p>13.9 In order to provide reasonable time to the Bidders to take the modification into account in preparing their Bid, or for any other reasons, <b>MVVNL</b> may, at its discretion, extend the deadline/ timeline for Bid submission.</p>
<b>14. Preparation of Bid/ Proposal and Bid Formats</b>	<p>14.1 The Bidder shall prepare its Bid and furnish required information and documents as per the guidelines, formats, forms, schedules, fees, and other specification in this Section, as well as the RFP Document in general.</p> <p>14.2 Strict adherence to the formats/ forms, wherever specified, is required. Wherever information has been sought in specified formats, the Bidder shall refrain from referring to brochures or pamphlets. Non-adherence to formats and/ or submission of incomplete information may be a ground for declaring the Bid as non-responsive. Each format must be duly signed and stamped by the authorized signatory of the Bidder.</p>
<b>15. Technical Bid/ Proposal Format and Content</b>	<p>15.1 The Technical Bid/Proposal shall be prepared using the Forms provided in Section 4 of the RFP and shall comprise the information, details and documents listed in subsequent clauses herein The Technical Bid/ Proposal shall not include any financial information. A Technical Proposal containing material financial information shall be declared non-responsive.</p> <p>15.2 The Technical Bid shall contain the list of all participating Consortium Members and Sub-contractor(s) (if applicable) participating in the Bid as per the format prescribed in Form 1 given in Section 4. Furthermore, the Technical Bid shall contain a covering letter by the Lead Consortium Member/ Sole Bidder duly designated and signed by all Members of that Bidding Consortium as per the format prescribed in Form 8 given in Section 4.</p> <p>15.3 The Technical Bid shall contain a legally enforceable Consortium Agreement (in case Bidder is a Consortium) entered amongst all Members of that Bidding Consortium, designating one of the Members to be the Lead Consortium Member as per the format prescribed in Form 8 given in Section 4. In the absence of a duly executed Consortium Agreement, the Bid shall not be considered for evaluation and will be rejected.</p> <p>15.4 The Technical Bid shall contain Power of Attorney from each Consortium Member in favour of the Lead Consortium Member as per the format prescribed in Form 9 given in Section 4. All submissions and representations by the Lead Member shall be deemed to be on-behalf of the entire consortium and shall be binding all the members of the</p>

	<p>Consortium.</p> <p>15.5 In case a Sole Bidder or any Consortium Member is a foreign entity, then it may submit a Board resolution/ Power of Attorney/ authorization, which should satisfactorily and unambiguously encompass all the terms and conditions of the Power of Attorney prescribed in Form 9 given in Section 4. In the event of Award of Contract, such foreign entity(ies) shall be required to have a registered office (under the Companies Act 1956/ 2013 with Registrar of Companies) in India.</p> <p>15.5.1 Provided further that such Board resolutions/Power of Attorney/authorization, as specified above, in case of a foreign entity, shall be supported by an unqualified opinion issued by the legal counsel of such foreign entity, stating that the Board resolutions are in compliance with the applicable laws of the respective jurisdictions of the issuing company and the authorizations granted therein are true and valid. In the case of a foreign entity, in the event, any and/or all of the documents/resolutions are in any other language other than English, then a duly notarized copy of such translation shall also be required to be submitted.</p> <p>15.6 The Lead Consortium Member/ Sole Bidder shall designate one person to represent the Bidding Consortium/ Bidder in its dealings with <b>MVVNL</b>. The person designated by the Lead Consortium Member/ Sole Bidder (registered Company) shall be authorized through a Power of Attorney as per Form 10 given in Section 4 to perform all tasks including, but not limited to, providing information, responding to inquiries, signing of Bid on behalf of the Consortium, etc. and attach the same in the Technical Bid.</p> <p>15.7 The Technical Bid shall contain signed Letter of Consent as per Form 11 given in Section 4 from each Consortium Member that the Bid has been reviewed and each element of the Bid is agreed to by them including but not limited to any commitment in the Project.</p> <p>15.8 The Technical Bid shall contain the Tender Fees and the Bid Security as per the format prescribed in Form 6 given in Section 4.</p> <p>15.9 The Technical Bid shall contain all documents required to prove/substantiate the Eligibility and Qualification Requirements of the Bidders or the Bidding Consortium specified in ITB 6.1 and Section 2 (as per the format prescribed in Form 2 given in Section 4):</p> <ol style="list-style-type: none"> <li>a) Company profile document with evidence of fields of competence for each Consortium Member</li> <li>b) Attested copy of Certificate of Registration/ Incorporation issued by the Registrar of Companies</li> </ol>
--	--

	<p>for each Consortium Member/ Bidder</p> <p>c) Certificate of Commencement of Business issued by the Registrar of Companies for Lead Consortium Member/ Sole Bidder clearly indicating the number of years of operation.</p>
15.10	The Bidder shall submit a preliminary Project implementation plan along with the Bid which shall include at least the following activities (as per the format prescribed in Form 3 given in Section 4).
15.11	In case of Award of the AMISP Contract, the detailed Project implementation plan, submitted as part of the Technical Bid, shall be revised and submitted by the AMISP, in consultation with the <b>MVVNL</b> , to ensure smooth takeover of existing <b>MVVNL</b> systems and any ongoing Services under the scope of the AMI Project.
15.12	The Technical Bid of the Bidder shall contain the indicative List of Material and Services in the format prescribed in Form 14 as given in Section 4 without any mention of costs/ prices.
15.13	The List of Material and Services shall be accompanied by the detailed specifications of the supply in the Technical Bid demonstrating responsiveness of the quoted Solution. The Bidder shall also indicate the country of origin of each equipment in Form 14 as given in Section 4. For supply of equipment / material from the country of origin other than India, the bidder shall submit performance certificate in support of satisfactory operation in India or a country other than the country of origin having climatic and operational conditions including ambient temperature similar to that of India for more than number of years, indicated in <b>BDS</b> in accordance with Order No. 11/05/2018-Coord. dated 17 September 2020 issued by the Ministry of Power including any amendments or modifications to the same from time to time.
15.14	The Technical Bid of the Bidder shall contain the names and details of the suitably qualified Bidder's representative and Key Personnel to perform the AMISP Contract as per the format provided in Form 4 given in Section 4. The data on their experience should be supplied using the Form 5 given in Section 4 for each candidate proposed.
15.15	Any removal/ change/ replacement of Key Personnel (as

	<p>provided in Form 4 and 5 given in Section 4) shall be notified to <b>MVVNL</b> within 7(seven) working days along with the Curriculum Vitae (CV) of the personnel replacing the previous personnel. The personnel replacing the previous key personnel shall have equivalent or better educational qualification and relevant professional experience</p> <p>15.16 Undertaking from the Technically OR Financially Evaluated Entity(ies) OR Undertaking from the Ultimate Parent Company. for total equity investment commitment, in the prescribed format in Form 18, to meet any shortfall in the equity investment by the Selected Bidder in the SPV.</p> <p>Note: The effective Equity holding Of the Selected Bidder in the SPV, as specified in Clause 4.2 shall be computed as per the provisions Of Clause 4.2.6 of this RFP.</p> <p>Provided further, in case the Sole Bidder or Member of a Consortium, (as the case may be) holds at least twenty six percent (26%) equity in such Technically; Financially Evaluated Entities, whose credentials have been considered for the purpose of meeting the Qualification Requirements as per the RFP, no such Undertaking shall be required from the Technically / Financially Evaluated Entities.</p> <p>If a Central Public Sector Enterprise (CPSE) / Public Sector Undertaking (PSU) or Subsidiary/ Joint Venture of a CPSE/ PSU is either the sole Bidder or a lead member of a Bidding Consortium, the bidder shall be exempted from compliance to Clause 15.16 of Section 3.</p> <p>15.17 Board resolutions. as per prescribed formats enclosed as Form- 19. duly certified by the Company Secretary or any Whole-time Director / Manager (supported by a specific Board Resolution), as applicable to the Bidder and mentioned hereunder,</p> <p>(a) Board resolution from the Sole Bidder (and any investing Affiliate / Parent Company / Ultimate Parent Company) committing one hundred percent (100%) in aggregate of the equity requirement for the Project - Format-1 of Form 19.</p> <p>(b) Board resolutions from each of the Consortium Member of the Bidding Consortium (and any investing Affiliate / Parent Company / Ultimate Parent Company) together committing to one hundred percent (100%) in aggregate of equity requirement for the Project, in case Bidder is a Bidding Consortium - Format-1 of Form 19;</p> <p>(c) In either of the cases as in (a) or (b) above as applicable, Board resolutions as per Format 2 of Form 19 for total equity</p>
--	---

	<p>investment commitment from the Technically / Financially Evaluated Entity(ies) whose technical / financial credentials had been considered for the purpose of meeting Qualification Requirements as per the RFP</p> <p>OR</p> <p>Board resolutions as per Format 2 of Form 19 from the Parent Company or the Ultimate Parent Company for total equity investment commitment. Provided that such Board resolutions, as specified in (a) or (b) or (c) above. In case of a foreign entity, shall be supported by an unqualified opinion issued by an independent legal counsel practicing in the relevant country, stating that the Board resolutions are in compliance with the applicable laws of the respective jurisdictions of the issuing company and the authorizations granted therein are true and valid.</p> <p>For clarity sake, illustrations identifying which Board Resolution shall be applicable in typical cases are provided in Annexure to Form 19.</p> <p>If a Central Public Sector Enterprise (CPSE) / Public Sector Undertaking (PSU) or Subsidiary/ Joint Venture of a CPSE/ PSU is either the sole Bidder or a lead member of a Bidding Consortium, the bidder shall be exempted from compliance to Clause 15.17 of Section 3.</p> <p>Note: Submission of the Technical Proposal in a materially wrong format may lead to the Proposal being deemed non-responsive to the RFP requirements.</p>
<p><b>16. Financial Bid/ Proposal Format and Content</b></p>	<p>16.1 The Financial Proposal shall be prepared using the Forms provided in Section 5 of the RFP and shall comprise the information, details and documents listed in subsequent clauses herein.</p> <p>16.2 The Financial Bid shall only be submitted electronically as per the format prescribed in Form 1 given in Section 5. No hard copy of the Financial Bid shall be submitted.</p> <p>16.3 The Financial Bid shall include only the cost of different meter types that are required for installation, operation and maintenance of the Project, Items wise component of auxiliary LT Items and the person-day rate for executing new requirement for software components. Price quoted should clearly mention the basic cost/ unit price including any other taxes/ duties/ levies and any other taxes/ duties/ levies, Goods and Service Tax (GST). The Financial Bid will be evaluated basis the total cost of the Project as quoted by the Bidder(s) for the Contract Period in Form 1 given in Section 5.</p> <p>16.4 The Bidder shall quote the AMISP Service Charge for each meter type for the Contract Period on INR per meter per month</p>

	<p>basis in line with the payment schedule as provided in the AMISP Contract. The Financial Bid shall be quoted in both 'numbers' and 'words'. In case of any discrepancy between the quoted Financial Bid in 'numbers' and 'words', the quoted Financial Bid in 'words' will prevail over the quoted Financial Bid in 'numbers'. The value of lumpsum (Rs. 900/- each type per meter) payment for each meter type is indicated in <b>BDS</b>. While providing the financial quote, the Bidder must consider the lump-sum (Rs. 900/- each type per meter) payment to AMISP. The AMISP shall accordingly quote the AMISP Service Charge for Contract Period.</p> <p>16.5 Unit prices (exclusive of all taxes/ duties/ levies/ cess etc.) (as provided in Form 1 given in Section 5) quoted by the Bidder shall be firm and final and shall remain constant throughout the Contract Period and shall not be subject to any modifications.</p> <p>16.6 Any items or prices omitted by the Bidder, if incurred at a later stage by the Bidder, within the scope of work as provided in the AMISP Contract, shall be borne by the Bidder with no financial liability on <b>MVVNL</b>.</p> <p>16.7 Any scope of work required for expansions during the Contract Period shall be supplied by the AMISP keeping the specifications and unit price same as per the List of Material and Services (as provided in Form 14 given in Section 4) and Financial Bid (as provided in Form 1 given in Section 5), respectively.</p> <p>16.8 All prices in the Financial Bid shall be quoted in Indian Rupees. The Bidder shall bear the risk related to foreign exchange variations during the Contract Period. The variation in the statutory taxes will be in accordance with the AMISP Contract.</p> <p>16.9 Alternative Bids with any financial implications shall be rejected.</p>
<b>C. Submission, Opening and Evaluation</b>	
<p><b>17. Submission of Bids/ Proposals and Bid Submission Deadline</b></p> <p><b>(a) Submission of Bids/ Proposals</b></p>	<p>17.1 Both Technical Bid and Financial Bid shall be digitally signed and submitted electronically using the e-Procurement system indicated in ITB 2.2 on or before the Bid Submission Deadline following the instructions therein. All the documents shall be scanned and uploaded however, where the data is required to be entered manually, the same shall be entered accordingly by the Bidder.</p> <p>17.2 Requisite Tender Fee and Bid Security in the specified form/ instrument shall be submitted in original so as reach before the</p>



<b>(b) Bid Submission Deadline</b>		Bid Submission Deadline, failing which the Bid shall be deemed non-responsive.
	17.3	In addition to the electronic submission and submission of Tender Fee and Bid Security in the specified form/ instrument in original as per ITB 17.2, if so specified in <b>BDS</b> , the Bidder shall also provide certain document in original/ hard copy/(ies) of the original/ revised (if any) in a sealed envelope before the Bid Submission Deadline.
	17.4	The hard copies to be submitted as per ITB 17.3 shall be in original and/ or attested as may be specified in <b>BDS</b> .
	17.5	The hard copy of the document as per ITB 17.2 and ITB 17.4 above shall be sent in a sealed envelope to <b>MVVNL</b> via Registered Post with Acknowledgement Due (RPAD), speed post or courier in the manner specified in ITB 17.4.3, which should reach <b>MVVNL</b> before the Bid Submission Deadline.
	17.6	The sealed envelope shall be clearly marked on the top with details mentioned in <b>BDS</b> . The sealed envelope shall be addressed to the <b>MVVNL</b> as specified in <b>BDS</b> . The sealed envelope shall also clearly mention the name of the Lead Consortium Member/ Sole Bidder submitting the Bid.
	17.7	The sealed envelope shall not contain the Financial Bid. The Financial Bid shall only be submitted electronically.
	17.8	In case of discrepancy between the electronically submitted documents and the physically submitted documents in the sealed envelope, the electronically submitted documents and the information contained therein shall prevail and be treated as the final submission.
	17.9	Insufficiency of the electronically submitted Bid shall not be compensated by any information, documentation or material provided additionally in the physically submitted documents in the sealed envelope.
	17.10	All Bids shall be electronically submitted and physically received, as may be specified in this Section, by <b>MVVNL</b> no later than the Bid Submission Deadline indicated in <b>BDS</b> as may be extended from time to time by the <b>MVVNL</b> .
	17.11	Bidders may prepare, edit, substitute or withdraw their offers any number of times online before the Bid Submission Deadline as may be permitted by the e-Procurement system. After the Bid Submission Deadline, the Bidder shall not, or attempt to, change or withdraw the Bid under any



	<p>circumstances. No written or online request in this regard shall be entertained.</p> <p>17.12 <del>Any Bid received by MVVNL, either electronically or physically, after the Bid Submission Deadline prescribed by MVVNL will not be uploaded and accordingly be rejected. In case of hard copy submissions, late Bids shall be returned unopened to the Bidder.</del></p> <p>17.13 MVVNL may, at its discretion, extend this Bid Submission Deadline by amending the RFP at any time prior to opening of the Bids, in which case all rights and obligations of MVVNL and the Bidders shall thereafter be subject to the deadline as extended.</p> <p>17.14 Any Proposal or its modification received by MVVNL after the deadline through any means or medium, whatsoever, shall be declared late and rejected, and promptly returned unopened.</p>
<b>18. Confidentiality</b>	<p>18.1 Information relating to the examination, evaluation, comparison, and recommendation of AMISP Contract award, shall not be disclosed to Bidders or any other persons not officially concerned with such process.</p> <p>18.2 Any attempt by a Bidder to influence MVVNL in the examination, evaluation, comparison, and post qualification of the Bids or AMISP Contract award decisions may result in the rejection of its Bid.</p> <p>18.3 If any Bidder, from the time of opening the Technical Bids to the time of AMISP Contract award, wishes to contact MVVNL on any matter related to the bidding process, it should do so in writing.</p>
<b>19. Opening of Technical Bids/ Proposals</b>	<p>19.1 The Technical Bids shall be opened at the date and time, and the address indicated BDS. In case hard copy submission of Technical Bid or certain document is requested by the MVVNL as per ITB 17 the physically submitted Technical Bids/ documents in the sealed envelope shall be opened simultaneously to check inter alia requisite submissions and for the Tender Fees and the Bid Security.</p> <p>19.2 The Bids shall be deemed to be under consideration immediately after they are opened and confirmation or receipt of the Tender Fee and Bid Security, and until an official intimation of award or rejection is made by MVVNL to the Bidders.</p> <p>19.3 MVVNL shall then separately evaluate the Bids with respect</p>

	<p>to the Eligibility and Qualification Requirements, sufficiency of the submission, conformation/ compliance/ responsiveness to all the mandatory requirements, terms, conditions, and specifications of the RFP Document without any deviation, reservation, or omission, and other parameters outlined in this RFP.</p> <p>19.4 The Financial Proposal shall remain unopened in the e-Procurement/ e-Tendering system securely, until they are opened in accordance with ITB 22.</p> <p>19.5 At the opening of the Technical Proposals the following shall be read out: (i) the name of the Bidder; (ii) any modifications to the Proposal submitted through the e-Procurement/ e-Tendering system prior to proposal submission deadline; and (iii) any other information deemed appropriate.</p>
<p><b>20. Bid/ Proposals Evaluation Overview and Verification/ Clarifications</b></p>	<p>20.1 The bidding process is designed to select the AMISP through a series of assessment of: (i) conformation/ compliance to all the mandatory requirements under applicable laws and this tender, terms, conditions, and specifications of the RFP Document without any material deviation, reservation, or omission; and (ii) the financial amounts quoted by the Bidder. The Bid submitted by the Bidder shall consist of a Technical Bid and a Financial Bid.</p> <p><b>First Stage-Fulfillment of Eligibility and Qualification requirements and determination of substantial responsiveness to the RFP Documents:</b> The Technical Bids shall be opened by <b>MVVNL</b> and be checked to determine:</p> <ul style="list-style-type: none"> <li>(i) whether the Bidders comply with the Eligibility Requirements, have offered eligible AMI Services in their Bids, as specified in ITB 6.1 and Section 2</li> <li>(ii) whether the Bidders meet the Qualification Requirement specified in ITB 6.2 and Section 2</li> <li>(iii) whether the Bids are substantially responsive to the RFP document including the requirements specified in Section 6 basis 'Clause by Clause' compliance to the RFP Document including the technical specifications and functional requirements (with amendments, if any) as per the format prescribed in Form 15 given in Section 4</li> </ul> <p><b>Second Stage-Opening of Financial Bid:</b> Financial Bids of all technically qualified Bidders would be opened, basis which the award of AMISP Contract shall be determined.</p> <p><b>Third Stage-Award of Project:</b> The "Successful Bidder" as defined in ITB 25 shall be awarded the AMISP Contract.</p>

	<p>20.2 The Bidder is not permitted to alter or modify its Bid/ Proposal in any way after the Bid Submission Deadline.</p> <p>20.3 <b>MVVNL</b>'s determination of the responsiveness of a Bid/ Proposal is to be based on the contents of the Proposal itself including any response to clarifications sought by <b>MVVNL</b> which does not alter the substance of the Proposal or the price.</p> <p>20.4 A substantially responsive Bid/ Proposal is one that conforms to all the mandatory requirements, terms, conditions, and specifications of the RFP Document without any material deviation, reservation, or omission, as defined in ITB 24.</p> <p>20.5 The Contract, if awarded, shall be executed in accordance with RFP document and any other conditions.</p> <p>20.6 Notwithstanding anything stated in the RFP Document, <b>MVVNL</b> reserves the right to verify the authenticity of the documents submitted for meeting the eligibility, qualification and/or other specified requirements and may request for clarifications any additional information/ documents from the Bidder. However, the Bidder shall not be permitted to alter the substance of the Proposal or the price under any circumstances whatsoever</p> <p>20.7 <b>MVVNL</b> reserves the right at its sole discretion to contact the Bidder's bank, lenders, financing institutions and any other persons as necessary to verify the Bidder's information/documents for the purpose of eligibility, qualification and/ or other specified requirements.</p> <p>20.8 <b>MVVNL</b> may verify the Bidder's technical and financial data by checking with the Bidder's clients/ lenders/ bankers/ financing institutions/ any other person as necessary.</p> <p>20.9 To assist in the examination, evaluation, comparison and post-qualification of the Bids, <b>MVVNL</b> may, at its discretion, ask any Bidder for a clarification of its Bid. Any clarification submitted by a Bidder that is not in response to a request by <b>MVVNL</b> shall not be considered. <b>MVVNL</b>'s request for clarification and the response shall be in writing. No change in the prices shall be sought, offered, or permitted by <b>MVVNL</b> in the evaluation of the Financial Bids.</p>
<p><b>21. Evaluation of Technical Bids/ Proposals</b></p>	<p>21.1 All Bids will first be evaluated for 'Clause by Clause' compliance to the RFP document and the AMISP Contract including the technical specifications and functional requirements (with amendments, if any) as per the format prescribed in Form 15 given in Section 4. The Bidders fulfilling the Eligibility and Qualification Requirement and having submitted substantially responsive Bids conforming to and meeting all the mandatory requirements, terms,</p>

	<p>conditions, and specifications of the RFP Document without any material deviation, reservation, or omission, as defined in ITB 24, shall qualify for the opening of Financial Bid.</p> <p>21.2 In the event the Technical Bid is substantially responsive, <b>MVVNL</b> may waive any deviation, reservation, or omission in the Bid as defined in ITB 24.1</p> <p>21.2.1 Provided that a Technical Bid is substantially responsive, <b>MVVNL</b> may request that the Bidder submit the necessary information or documentation, within a reasonable period of time, to rectify nonmaterial, nonconformities or omissions in the Technical Bid related to documentation requirements. Such omission shall not be related to any aspect of the price Bid. Failure of the Bidder to comply with the request may result in the rejection of its Bid.</p>
<b>22. Opening of Financial Proposals</b>	<p>22.1 At the completion of the technical evaluation, <b>MVVNL</b> shall intimate the technically qualified Bidders for opening of Financial Bids, along with the date, time and venue of opening of Financial Bids.</p> <p>22.2 The Financial Bids shall be opened through the e-Procurement system referred to in ITB 2.2, in the presence of authorized representatives of all technically qualified Bidders who chose to be present at the specified venue on the specified date and time.</p>
<b>23. Evaluation of Financial Bids/ Proposals</b>	<p>23.1 Provided that the Technical Bid is substantially responsive, <b>MVVNL</b> will correct arithmetical errors during evaluation of Financial Proposals on the following basis:</p> <ul style="list-style-type: none"> <li>i. if there is a discrepancy between the unit price and the total price that is obtained by multiplying the unit price and quantity, the unit price shall prevail and the total price shall be corrected, unless in the opinion of <b>MVVNL</b> there is an obvious misplacement of the decimal point in the unit price, in which case the total price as quoted shall govern and the unit price shall be corrected;</li> <li>ii. if there is an error in a total corresponding to the addition or subtraction of subtotals, the subtotals shall prevail, and the total shall be corrected;</li> <li>iii. if there is a discrepancy between words and figures, the amount in words shall prevail. However, where the amount expressed in words is related to an arithmetic error, the amount in figures shall prevail subject to (i) and (ii) above.</li> </ul> <p>Except as provided in (i) to (iii) herein above, <b>MVVNL</b> shall reject the Financial Bid if the same contains any other computational or arithmetic discrepancy or error.</p>
<b>24. Deviations, Reservations and</b>	<p>24.1 During the evaluation of Bids/ Proposals, the following definitions apply:</p> <p>(a) “Deviation” is a departure from the requirements specified in</p>

<p><b>Omissions</b></p>	<p>the RFP document;</p> <p>(b) “Reservation” is the setting of limiting conditions or withholding from complete acceptance of the requirements specified in the RFP document; and</p> <p>(c) “Omission” is the failure to submit part or all of the information or documentation required in the RFP document.</p> <p>24.2 A substantially responsive Bid is one that meets the requirements of the bidding document without material deviation, reservation, or omission. A material deviation, reservation, or omission is one that:</p> <p>(a) if accepted, would:</p> <p>(i) affect in any substantial way the scope, quality, or performance of the Goods and Related Services specified in the Contract; or</p> <p>(ii) limit in any substantial way, inconsistent with the bidding document, the <b>MVVNL</b>'s rights or the Bidder's obligations under the Contract; or</p> <p>(b) if rectified, would unfairly affect the competitive position of other Bidders presenting substantially responsive Bids.</p>
<p><b>25. Successful / Selected Bidder</b></p>	<p>25.1 The price as per the Financial Proposal/ Bid of all technically qualified Bidders, determined upon evaluation of Financial Proposals/ Bids, shall be the basis for determination of the Successful Bidder/ Selected Bidder.</p> <p>25. The technically qualified Bidder with the lowest Financial Bid shall be considered as the Successful Bidder/ Selected Bidder and shall be considered for award of the AMISP Contract.</p> <p>25.3 If the Successful Bidder/ Selected Bidder does not accept the correction of errors as per ITB 23.1, its Bid shall be disqualified, and its Bid Security shall be forfeited.</p>
<p><b>D. Award of Contract</b></p>	
<p><b>26. Award Criteria</b></p>	<p>26.1 Subject to ITB 25.3, the <b>MVVNL</b> shall award the Contract to the Successful Bidder/ Selected Bidder.</p> <p>26.2 <b>MVVNL</b> shall present the Letter of Award (as per the format prescribed in Form 2 given in Section 8) to the Successful Bidder and invite the Performance Security in order to sign the AMISP Contract to implement the Project.</p> <p>26.3 The Successful Bidder shall provide an undertaking that the key staff identified for the Project (as submitted in its Technical Bid) shall be available for the respective proposed work requirement, anytime during the duration of the Project, till its successful completion</p> <p>26.4 If for any reason the Bid of the Successful Bidder is rejected or Letter of Award issued to the Successful Bidder is cancelled, <b>MVVNL</b> is empowered to take decisions for any of</p>

		<p>the following:</p> <p>a) Consider the next lowest evaluated Bid from eligible and qualified Bidder whose bid is determined substantially responsive; or</p> <p>b) Annul the Bid process; or</p> <p>c) Take any such measure as may be deemed fit in the sole discretion of <b>MVVNL</b>, as applicable.</p>
27. <b>MVVNL's Right to Vary Quantities at the time of Award</b>	27.1	<b>MVVNL</b> reserves the right to increase or decrease the number of items under the AMISP Contract subject to the limit of -20% (twenty percent) up to +30% (thirty percent) of the existing number of items (as provided in Form 1 given in Section 5), covered under the AMISP Contract, without any change in the unit prices or other terms and conditions of the AMISP Contract and the Bid.
	27.2	<p>Further, the quantity variation against Auxiliary LT items (as provided in Section B of Form 1 given in section 5) shall be as follows:</p> <p>The variation in quantity of the items shall be within the limit of plus/minus (+/-) hundred percent (100%) for individual items. In case the quantity variation of the individual items is beyond the limit specified above, the unit rates for the quantity beyond the said limit, shall be mutually agreed based on prevailing market rates as may be fair and reasonable.</p> <p><b>MVVNL</b> reserves right to de-scope any component mentioned in Section B of Form 1 of Section 5, as per requirement.</p>
28. <b>Letter of Award</b>	28.1	Prior to the expiry of the period of Bid validity, <b>MVVNL</b> shall notify the successful Bidder, in writing, by issuing the Letter of Award, that its Bid has been accepted.
	28.2	Until the AMISP Contract is prepared and executed, the notification of award shall constitute a binding contract.
29. <b>Signing of Contract and Contract Performance Security</b>	29.1	Within 21 (twenty-one) Days of receipt of the Letter of Award, the successful Bidder shall sign the AMISP Contract <b>with respective MVVNL</b> .
	29.2	The <b>MVVNL</b> shall, as a condition precedent to the award of the contract to the selected bidder, establish a Direct Debit Facility as mentioned in GCC Clause 5.2
	29.3	Within 14 (fourteen) Days of the receipt of Letter of Award from <b>MVVNL</b> , the Successful Bidder shall furnish the Performance Security, using for that purpose the format of Performance Security given in Form 1 in Section 8. Immediately upon furnishing of Performance Security, AMISP may request the <b>MVVNL</b> to execute the AMISP Contract.
	29.3.1	Within 14 (fourteen) Days of the receipt of Letter of Award

	<p>from <b>MVVNL</b>, the Successful Bidder shall submit a copy of the agreement between each of the Sub-contractor(s) and the Bidder, in case the Sub-contractor(s) is not the Sole Bidder/ a member of the Consortium, guaranteeing back-to-back service and support for the total duration of the project.</p> <p>In case the bidder proposes RF as the communication technology, the successful bidder shall submit a copy of the agreement between the RF Technology solution provider(s) and the Bidder, guaranteeing back-to-back service and support for the total duration of the project.</p> <p>29.4 In case the Selected Bidder is a sole bidder or a bidding consortium, the members of the consortium shall incorporate themselves as a company called the Special Purpose Vehicle (SPV) under the Companies Act, 2013 with 100% equity ownership to execute the Project. The SPV so incorporated shall sign the contract agreement along with the Selected Bidder.</p> <p><i>Note: If a Central Public Sector Enterprise (CPSE) / Public Sector Undertaking (PSU) or Subsidiary/ Joint Venture of a CPSE/ PSU is either the sole Bidder or a lead member of a Bidding Consortium, the bidder shall be exempted from compliance to Clause 29.4 of Section 3.</i></p> <p>29.5 Failure of the Successful Bidder to submit the above-mentioned Performance Security or submit the above-mentioned agreement or sign the AMISP Contract or if the successful bidder withdraws, shall constitute sufficient grounds for the annulment of the award and forfeiture of the Bid Security. In that event, <b>MVVNL</b> shall re-tender the case.</p>
<p><b>30. Additional Security</b></p>	<p>30.1 In case % of equity participation of any of the consortium members in the SPV is less than 10% or if any of the consortium members is not willing to be a part of the SPV to be formed, except when the said consortium member is a Central Public Sector Enterprise (CPSE) / Public Sector Undertaking (PSU) or Subsidiary/ Joint Venture of a CPSE/ PSU, the bidder would have to furnish an additional security as per SCC.</p> <p>30.2 Within 14 (fourteen) Days of the receipt of Letter of Award from <b>MVVNL</b>, the Successful Bidder shall furnish the additional Security, using for that purpose the format of Additional Security given in Form 3 in Section 8. Immediately upon furnishing of Additional Security, AMISP may request the <b>MVVNL</b> to execute the AMISP Contract.</p> <p>30.2.1 Within 14 (fourteen) Days of the receipt of Letter of Award from <b>MVVNL</b>, the Successful Bidder shall submit a copy of the agreement between the said consortium member/s (<i>whose % of equity participation in the SPV is less than 10% or the said member who is not willing to be a part of the SPV to be formed</i>) and the lead Bidder, guaranteeing back-to-back service and support for the total duration of the</p>



	<p>project.</p> <p>30.3 Failure of the Successful Bidder to submit the above-mentioned additional Security or submit the above-mentioned agreement shall constitute sufficient grounds for the annulment of the award and forfeiture of the Bid Security. In that event, <b>MVVNL</b> may award the AMISP Contract to the next lowest Bidder.</p>
<p>31. <del>Advance Payment security (Optional)</del></p>	<p>31.1 <del>[<b>MVVNL</b>, at its discretion, may provide to the successful bidder an interest bearing advance payment against an advance payment security furnished by the successful bidder in the form of a bank guarantee for [10] % of the Contract Price.</del></p> <p>31.2 <del>Within 14 (fourteen) Days of the receipt of Letter of Award from the <b>MVVNL</b>, the Successful Bidder shall furnish the Advance Payment Security, using for that purpose the format of Advance payment Security given in Form 4 in Section 8.</del></p> <p>31.3 <del>The <b>MVVNL</b> shall provide an advance payment for [70] % of the advance payment security furnished by the successful bidder, at the time of contract signing.</del></p> <p>31.4 <del>The amount of the security shall be reduced in proportion to the value of the services executed by and paid to the successful bidder from time to time and shall automatically become null and void when the full amount of the advance payment has been recovered by the <b>MVVNL</b>. The security shall be returned to the successful bidder immediately after its expiration</del></p> <p>31.5 <del>The interest rate on advance payment shall be Marginal Cost of Funds Based Lending Rate (MCLR) for one year of the State Bank of India, prevailing on the date of advance payment to the Successful Bidder. The interest accrued on interest bearing advance shall be adjusted first before releasing any payment. The interest rate shall be calculated on the daily progressive balances outstanding as on the date of recovery/adjustment i.e., on daily rest basis.]</del></p>
<p>32. Armoured service cable funding terms</p>	<p>32.1 Payment against Armoured service cable shall be paid to the AMISP on a lumpsum (capex) basis, as per terms and conditions of the AMISP contract.</p> <p>32.2 The cost of armoured service cable shall not be included in the per meter per month cost discovered as part of bidding process. Cost of armoured service cable shall be quoted separately under section B of the Annexure of the financial proposal.</p> <p>32.3 Funding for armoured service cable shall be made from Distribution Infrastructure works component sanctioned for the <b>MVVNL</b> under RDSS.</p>



## E. Bid Data Sheet

ITB Reference	A. General Provisions
1.1 (e)	Incorporation of a Special Purpose Vehicle (SPV) by the Selected Bidder for project implementation would be mandatory, in both cases, where the Bidder is either a Sole bidder or a Consortium. However, if a Central Public Sector Enterprise (CPSE) / Public Sector Undertaking (PSU) or Subsidiary/ Joint Venture of a CPSE/ PSU is either the sole Bidder or a lead member of a Bidding Consortium, then creation of an SPV is not mandatory.
1.1 (cc)	<p>MVVNL provides power to almost 7.5 crore people in 19 districts            Details of Offices, Districts and Consumers in the MVVNL as on 31.03.2020 are as follows:</p> <p><b>Discom-wise Structure</b>  <b>Zone- 6 Nos.</b>  <b>Circle- 29 Nos.</b>  <b>Distribution division- 104 Nos.</b>  <b>SDO- 315 Nos.</b>  <b>Test Division- 30 Nos.</b></p>
1 (mm)	<p><b>Bareilly, Lucknow, Devipatan, Ayodhya, LESA Trans and LESA CIS Distribution Zones of MVVNL</b>  <b>DETEILS IN EXHIBIT-2&amp;3</b>  <b>The implementation of project is planned in two phases as per the Gazzate Notification of Mop GOI 230 dated 19.08.2021 (EXHIBIT-5)</b></p>
2.2	<p>Bidding against RFP shall be conducted through/ with Electronic –Procurement (e-Procurement/ e- Tendering) System.</p> <p><b>MVVNL</b> shall use the following Electronic-Procurement system to manage this Request for Proposal (RFP) process:  <a href="https://etender.up.nic.in">https://etender.up.nic.in</a></p> <p>The electronic-procurement system shall be used to manage the following part of the RFP process:  <i>[e.g., issuing RFP, corrigendum/ addendums, submissions of Proposals, opening of Proposals etc.]</i></p> <p>To aid and facilitate the Bidders on e-Procurement/ e-Tendering process a detailed manual on the same titled <b>Bidder Help Manual for e-Bidding</b> has been provided annexed to the Bid Data Sheet as <b>Annexure I (BDS)</b>. The same may be utilized by the Bidders.</p>
2.2.2	<p><b>Superintending Engineer (Commercial)</b>            MVVNL Head Office,            4-A, Gokhale Marg,            Lucknow (U.P.)-226001            Phone: +91-8004922297            Email: <a href="mailto:mvvnlsmrds@gmail.com">mvvnlsmrds@gmail.com</a></p>

2.3	<p>The name of the Contract is: RFP for <b>Appointment of Advanced Metering Infrastructure (AMI) Service Provider for Smart Prepaid Metering in MVVNL, U.P., India on DBFOOT basis</b></p> <p>RFP/ Tender No <b>RDSS/0002/2022</b></p>
2.4	<p>PuVVNL/MVVNL/DVVNL/PVVNL/KESCO wants to select AMISP in to include of its consumers, Distribution Transformers and 11kV feeders. MVVNLs have contracts with M/s EESL to install a total of 40 lac smart meters (11.47/9.04/6.29/11.63/1.56 lac respectively) for their. Further, UPPCL is in process of implementation of Revenue Management System (RMS) which includes setting up of the new unified system on Cloud Infrastructure, on pay-per-consumer subscription basis, configure, customize, integrate and test the system and migrate the data all the existing consumers of PuVVNL/MVVNL/DVVNL/PVVNL/KESCO (In phases) into the new integrated Unified RMS solution by the selected agency. Under RMS scope of work, PuVVNL/MVVNL/DVVNL/PVVNL/KESCO has included following modules:</p> <ol style="list-style-type: none"> <li>1. Metering –for all consumers including electric vehicles and DER/ Energy storage providers.</li> <li>2. Billing –for all Post-paid and Prepaid (STS/CTS/Smart), multi-point/Open-Access consumers, including rating engine.</li> <li>3. Collection –for all manual, digital, POS channels including advance or deferred modes from individual or group of consumers.</li> <li>4. New Connection –for all customer types.</li> <li>5. Disconnection, Reconnection and Dismantling –for all customer types including Receivables Management.</li> <li>6. Web Self Service (WSS) –for all types of Consumer service request, bill generation, payments and account information and management.</li> <li>7. Customer Relationship Management (CRM) –for complaint logging, capturing, handling, tracking, redressal, compensation and reporting for customer and non-customer (supply related) complaints.</li> <li>8. Management Information System (MIS) –with Real time management information dashboard for monitoring, reporting and ATR.</li> <li>9. Document Management System (DMS) –including protected documents as per data privacy laws of India.</li> <li>10. Energy Audit (EA) –with granularity at every source level by using network hierarchy for minimizing losses and compliance reporting to UPERC, Governments and lender.</li> <li>11. Mobile Applications –for customer interfacing, for field activity and workforce management and meter reading, billing and payment</li> <li>12. Data Life Cycle Management – for Data Archival.</li> </ol>

2.6	<p><b>A Pre Bid Meeting will be held as per the details below.</b></p> <p><b>[Date of Pre Bid Meeting: .....</b>  <b>Time: .....</b> Hours (IST)  <b>Address:.....</b>  <b>Telephone: ....., Fax: .....</b>  <b>E-mail: .....</b>  <b>Contact person/Meeting coordinator:.....]</b></p> <p><i>Due to prevailing COVID-19 conditions and as per the applicable directives and SoP, if so necessitated the pre bid meeting may be held over a Video Conferencing Link for which will be made available seven days prior to holding this meeting at MVVNL website. &lt;insert if required&gt;</i></p>																
2.8	<p>Format for Sending Query to <b>MVVNL</b></p> <p><i>[Query may be sent in hard copy to the Nodal Officer of <b>MVVNL</b>, at the below-mentioned address AND/ OR via email to E-mail ID]</i></p> <p>[Reference No.]</p> <p>From:  [Address of the Bidder]  [Telephone No., Fax No., Email]  [Date]</p> <p>To: <a href="mailto:mvvnsmrdss@gmail.com">mvvnsmrdss@gmail.com</a></p> <p><b>Sub: Query.</b>  <i>Ref: [Mention RFP Reference here].</i></p> <p>Dear Sir/ Madam,  Please find below our query with respect to the RFP subject to the terms and conditions therein:</p> <table border="1" data-bbox="483 1396 1377 1640"> <thead> <tr> <th>S. No.</th> <th>Reference Clause No.</th> <th>Page No.</th> <th>Query</th> </tr> </thead> <tbody> <tr> <td>1.</td> <td></td> <td></td> <td></td> </tr> <tr> <td>2.</td> <td></td> <td></td> <td></td> </tr> <tr> <td>3.</td> <td></td> <td></td> <td></td> </tr> </tbody> </table> <p>Thanking you,  Yours Sincerely,  <i>[Insert Signature here]</i>  <i>[Insert Name here]</i>  <i>[Insert Designation here]</i></p>	S. No.	Reference Clause No.	Page No.	Query	1.				2.				3.			
S. No.	Reference Clause No.	Page No.	Query														
1.																	
2.																	
3.																	

## B. Preparation of Proposals

10.1	Document Checklist and List of Forms		
S. No.	Document	RFP Section Reference	
1.	Tender Fee	1,3	
2.	List of Consortium Members and Subcontractor(s) (as applicable) as per the format prescribed in Form 1 given in Section 4	4	
3.	Bidder Information as per the format prescribed in Form 2 given in Section 4	4	
4.	Project Implementation Plan as per format provided in Form 3 given in Section 4	4	
5.	Curriculum Vitae of key personnel as per format provided in Form 4 and Form 5 given in Section 4	4	
6.	Bid Security in the form of Demand Draft or Bank Guarantee as per format prescribed in Form 6 given in Section 4	4	
7.	Covering Letter for Submission of Bid by Sole Bidder / Lead Consortium Member as per format prescribed in Form 7 given in Section 4	4	
8.	Consortium Agreement Format entered amongst all Members of the Bidding Consortium as per format prescribed in Form 8 given in Section 4	4	
9.	Power of Attorney by each Consortium Member in favour of Lead Consortium Member as per format prescribed in Form 9 given in Section 4	4	
10.	Power of Attorney by Lead Consortium Member/ Sole Bidder authorizing an Individual Designated Representative for the Consortium/ Bidder as per the format prescribed in Form 10 given in Section 4	4	
11.	Letter of Consent by each Consortium Member reviewing each element of the Bid as per format prescribed in Form 11 given in Section 4	4	

	<p>12. <b>For Lead Member in case of Consortium Bidding / Sole Bidder Experience [Refer Clause 8.1 in Section 2]:</b></p> <ul style="list-style-type: none"> <li>i. References along with requisite contract/ Purchase Order (PO)/ Work Order (WO). The references should indicate client name, scope of work, Project start date (as per the format prescribed in Form 13 given in Section 4);</li> <li>ii. Documentary evidence of Project completion such as client completion certificate, proof of payment received and client certificate of delivery of material, proof of asset capitalized in books of accounts (as applicable)/ and similar proofs along with contact details of the client.</li> </ul>	4
	<p>13.1 <b>For System Integration Experience [Refer Clause 8.1 and 8.2 D1-D2 in Section 2]:</b></p> <ul style="list-style-type: none"> <li>i. References along with requisite contract/ Purchase Order (PO)/ Work Order (WO). The references should indicate client name, scope of work, Project start date (as per the format prescribed in Form 13 given in Section 4);</li> <li>ii. Documentary evidence of completion of the Project or completion of Go-Live status (i.e., Go-live certificate, UAT testing certificate etc.) or other documentary evidence indicating completion (e.g., proof of payment received and client certificate for supply of material or similar proofs) along with contact details of the client;</li> <li>iii. Client certificate and other documentation for implementation performance/ operation.</li> <li>iv. Agreement entered with the sole bidder / lead bidder (as per format prescribed in Form 23 of section 4)</li> </ul>	4

	<p>13.2 <b>For Meter Manufacturer Eligibility [Refer Clause 8.2 A1-A4 in Section 2]:</b></p> <ul style="list-style-type: none"> <li>a) References along with requisite contract/ Purchase Order (PO)/ Work Order (WO). The references should indicate client name, scope of work, Project start date (as per the format prescribed in Form 14);</li> <li>b) Documentary evidence of completion of the Project or other documentary evidence indicating completion of supply (e.g. proof of payment received/ proof of asset capitalized in books of accounts (as applicable) and client certificate for supply of material or similar proofs) along with contact details of the client;</li> <li>c) Client certificate and other documentation for implementation performance/ operation</li> <li>d) A valid registration certificate of manufacturing unit along with Self-declaration by manufacturer and factory license certificate for requisite facilities.</li> <li>e) A valid ISO certificate on or before the date of submission of the bid</li> <li>f) A valid registration certificate mentioning issue/renewal/expiry date.</li> <li>g) A MAF signed on the letterhead of the Smart Meter manufacturer, addressed to the Sole/ Lead Bidder (as per the format prescribed in Form 22).</li> <li>h) Agreement entered with the sole bidder / lead bidder (as per format prescribed in Form 23 of section 4)</li> </ul>	
--	--	--

	<p>13.3 <b>For Head End System (HES) solution provider Eligibility [Refer Clause 8.2 B1 in Section 2]:</b></p> <ul style="list-style-type: none"> <li>a) References along with requisite contract/ Purchase Order (PO)/ Work Order (WO). The references should indicate client name, scope of work, Project start date (as per the format prescribed in Form 13 given in Section 4);</li> <li>b) Client certificate/ report issued by Client / MDMS OEM / solution provider and other documentation for implementation performance/ operation.</li> <li>c) A MAF signed on the letterhead of the HES Solution provider, addressed to the Sole/ Lead Bidder (as per the format prescribed in Form 22).</li> <li>d) Agreement entered with the sole bidder / lead bidder (as per format prescribed in Form 23 of section 4)</li> </ul>		
	<p>13.4 <b>For Meter Data Management System (MDMS) solution provider Eligibility [Refer Clause 8.2 C1-C3 in Section 2]:</b></p> <ul style="list-style-type: none"> <li>a) References along with requisite contract/ Purchase Order (PO)/ Work Order (WO). The references should indicate client name, scope of work, Project start date (as per the format prescribed in Form 13 given in Section 4);</li> <li>b) Documentary evidence of completion of the Project or completion of Go-live status (i.e., Go-live certificate, UAT testing certificate etc.) of the respective project as per the definition of Go-Live/ UAT specified therein or other documentary evidence indicating completion (e.g., proof of payment received/ proof of asset capitalized in books of accounts (as applicable) and client certificate for supply of material or similar proofs) along with contact details of the client</li> <li>c) Client certificate and other documentation for implementation performance/ operation.</li> <li>d) A valid ISO certificate or CMMi certificate on or before the date of submission.</li> <li>e) A MAF signed on the letterhead of the MDMS Solution provider, addressed to the Sole/ Lead Bidder (as per the format prescribed in Form 22).</li> <li>f) Agreement entered with the sole bidder / lead bidder (as per format prescribed in Form 23 of section 4)</li> </ul>		

	<p>13.5 <b>For RF Solution Provider Eligibility [Refer Clause 8.2 E1-E3 in Section 2]:</b></p> <p>a. Certificate of Incorporation and Registration certificate along with Memorandum &amp; Articles of Association. Copy of valid Licenses (In case of RF, Valid certificate issued by Wireless Planning &amp; Coordination (WPC) Wing of the Ministry of Communications, GOI</p> <p>b. References along with requisite contract/ PO/ WO. The references should indicate client name, scope of work, project start date and date of completion of installation. Certificate from the client on successful implementation of the project.</p> <p>c. Signed agreements/ MoUs for integration of NIC module or Certificate of successful integration.</p> <p>d. A MAF signed on the letterhead of the RF Solution provider, addressed to the Sole/ Lead Bidder (as per the format prescribed in Form 22).</p> <p>e. Agreement entered with the sole bidder / lead bidder (as per format prescribed in Form 23 of section 4)</p>		
	<p>14. <b>For Financial Strength [Refer Clause 8.1 in Section 2]:</b> Audited Annual financial statements, Balance Sheet and P&amp;L Account of all Consortium Members/ Sole Bidder for the respective Financial Years as per the format prescribed in Form 12 given in Section 4</p>	4	
	<p>15. List of Material and Services as per format provided in Form 14 given in Section 4</p>	4	
	<p>16. Table of Compliance as per format provided in Form 15 given in Section 4</p>	4	
	<p>17. Financial Bid as per format provided in Form 1 given in Section 5</p>	5	
	<p>18. Performance Security as per the format prescribed in Form 1 given in Section 8</p>	8	
	<p>19. Letter of Award as per the format prescribed in Form 2 given in Section 8</p>	8	
	<p>20. Copy of this RFP with sign and official seal on every page</p>	1 to 8	
	<p>21. Format for Sending Query to <b>MVVNL</b> for clarification</p>	3	
<p><b>12.1</b></p>	<p>The Bid shall remain valid until i.e. up to and including [..... <b>120/150/ or 180 days</b> .....] <del>&lt;insert the requirement, as applicable&gt;</del> reckoned from the Bid Submission Deadline specified in ITB 17, as may be extended by the <b>MVVNL</b>.</p>		



12.2	Currency and the amount of Bid Security to be furnished by the Bidder is: Currency: INR Amount: 2,00,00,000
12.3(a)	Banks by whom Bank Guarantee is required to be issued: Any Indian Scheduled Commercial Bank
12.3(a)	Bid Security may be furnished in other forms mentioned below: <b>Bank Name- State Bank of India</b> <b>Account Number- 10101985738</b> <b>IFSC Code- SBIN 0003347</b> <b>Branch Name- State Bank of India, Ashok Marg, Lucknow</b>
13.1	Clarifications may be requested by Bidder by date provided in Tentative Schedule. Request to be sent at: Superintending Engineer (Commercial) MVVNL Head Office, 4-A, Gokhale Marg, Lucknow (U.P.)-226001 Phone: +91-8004922297 Email: <a href="mailto:mvvnlsmdss@gmail.com">mvvnlsmdss@gmail.com</a>
15.13	Number of years: Contract Period 10 years
16.4	Value of lump-sum payment for each meter type is as indicated below: <b>[Rs. 900 per meter]</b>
<b>C. Submission, Opening and Evaluation</b>	
17.3	Bidder shall provide the following document in original/ hard copy:  Bidder shall submit hard copy also at the office of Nodal Officer (smart meter) <b>MVVNL</b> of technical bids in addition to submission of soft copy on e-tender website provided in RFP and all further correspondences.
17.4	The following documents shall be submitted in original: 1. Bank Guarantee for Bid Security Amount 2. Affidavits as submitted in Technical Bid 3. Agreements as submitted in Technical Bid 4. Any other document which may be sought by <b>MVVNL</b> during technical evaluation of Bid.
17.6	Details to be marked on the sealed envelope: <b>RFP no. RDSS/0002/2022 and details including RFP Name, Bid Submission Deadline, Time and Date of Bid Opening, name of the Lead Consortium Member/ Sole Bidder submitting the Bid</b>

	<p>Sealed Envelope(s) to be addressed to:  Address: Superintending Engineer (Commercial)  MVVNL Head Office,  4-A, Gokhale Marg,  Lucknow (U.P.)-226001  Email: <a href="mailto:mvvnlsmdss@gmail.com">mvvnlsmdss@gmail.com</a>  Contact Person: Manoj Kumar Sharma  Phone: +91-8004922297</p>
<b>17.10</b>	<p>The Bid Submission Deadline is:  Date: 03.09.2022  Time: 17:00 hrs</p>
<b>19.1</b>	<p>The Technical Bids/ Proposals shall be opened as indicated below:  The opening part-1 shall take place at:  MVVNL Head Office,  <b>Date: 05.09.2022</b>  <b>Time: 16:00 hrs</b>  <del>Due to prevailing COVID-19 conditions if necessitated and, the bid opening meeting may be held over a Video Conferencing, Link for which will be made available at least 7 Days prior to the Bid Opening event, at MVVNL website [.... Indicate the website]</del></p>

## Annexure I (BDS)

### Bidder Help Manual for E-Bidding

E-TENDERING INSTRUCTIONS	<p><b>General</b></p> <p>Submission of Bids is only through online process for this Tender. For conducting Electronic Tendering, <b>MVVNL</b> is using the Portal of NIC, a Government of India Undertaking and the tender is being uploaded to website <a href="http://www.etender.up.nic.in">www.etender.up.nic.in</a></p>
Tender Bidding Methodology	Sealed Bid System: e-tenders are invited in two parts (Part-I Techno Commercial and Part-II Financial Bid).
Broad Outline of Activities from Bidder's perspective	<ol style="list-style-type: none"> <li>i. Procure a Digital Signing Certificate (DSC)</li> <li>ii. Register on NIC (<a href="https://etender.up.nic.in">https://etender.up.nic.in</a>).</li> <li>iii. Create Users and assign roles on NIC Portal.</li> <li>iv. View Notice Inviting Tender (NIT) on NIC Portal.</li> <li>v. Download Official Copy of Tender Documents from NIC Portal.</li> <li>vi. For Clarification to Tender Documents on NIC Portal:</li> <li>vii. -Query to <b>MVVNL</b> (Optional)</li> <li>viii. -View response to queries posted by <b>MVVNL</b>, as addenda.</li> <li>ix. Bid-Submission /Bid Upload on NIC Portal.</li> </ol>
Digital Certificates	For integrity of data and its authenticity/ non-repudiation of electronic records, and be compliant with IT Act 2000, it is necessary for each user to have a Digital Certificate (DC), also referred to as Digital Signature Certificate (DSC), of Class 2 or above, issued by a Certifying Authority (CA) licensed by Controller of Certifying Authorities (CCA) [refer <a href="http://www.cca.gov.in">http://www.cca.gov.in</a> ].
Registration	<ol style="list-style-type: none"> <li>i. To use the e-Tender Portal of NIC (<a href="https://etender.up.nic.in">https://etender.up.nic.in</a>), bidder needs to register on the Portal (if not registered earlier). Registration of each organization is to be done by one of its senior persons who will be the main person coordinating for the e-tendering activities. In NIC PORTAL terminology, this person will be referred to as the Super User (SU) of that organization. For further details, please visit the website/Portal, and click on the 'Supplier Organization' link under 'Registration' (on the Home Page), and follow further instructions as given on the site.</li> <li>ii. Pay Registration Fee and other charges (as applicable) on the NIC Portal.</li> </ol>
Bid Related Information for this Tender (Sealed Bid)	<p>The entire bid-submission would be online on NIC Portal and upload the Necessary scanned documents such as Demand draft, bid documents etc. Broad outline of submissions is as follows:</p> <ol style="list-style-type: none"> <li>(i) Submission of digitally signed copy of Tender Documents/Addendum/addenda</li> <li>(ii) Two Parts of Bid <ul style="list-style-type: none"> <li>• <b>Techno-commercial Part-I</b> containing prequalifying documents, bid fee/bid security proof and technical proposal</li> <li>• <b>Financial-Part-II</b> containing price bid</li> </ul> </li> </ol>

## Section 3. Instructions to Bidders and Bid Data Sheet

	<p>Bidders must ensure that all documents uploaded on e-tender Portal as files or zipped folders, contain valid files and are not corrupt or damaged due to any processing at bidder PC system like zipping etc. It shall be the responsibility of bidder himself for proper extractability of uploaded zipped files. Any error/ virus creeping into files/folder from client end PC system cannot be monitored by e-tender software/ server and will be bidder's responsibility only.</p> <p>In case the files are non-extractable or illegible otherwise, then the bidder's authorized representative shall be given one chance by Tender Opening Committee to open &amp; demonstrate the contents of bid data downloaded from the e-tender Portal in his presence.</p> <p>If, even after above chance, the bidder is unable to open &amp; demonstrate the contents of bid data downloaded from the e-tender Portal in his presence then no fresh bid in any form, soft or hard copies, shall be accepted by tendering authority and his bid shall be summarily rejected and treated as non-responsive.</p>
Special Note on Security Of Bids	<p>Security related functionality has been rigorously implemented in NIC Portal in a multi-dimensional manner. Starting with 'Acceptance of Registration by the Service Provider', provision for security has been made at various stages in Electronic Tender's software. There is an additional protection with SSL Encryption during transit from the client-end computer of a Supplier organization to the e-tendering server/ Portal.</p>
Minimum Requirements At Bidder's End To Upload Bid	<ol style="list-style-type: none"> <li>1. Computer System with good configuration.</li> <li>2. Broadband connectivity.</li> <li>3. Microsoft Internet Explorer 6.0 or above.</li> <li>4. Digital Certificate(s) for bidders.</li> </ol>
Other Instructions	<p>It is strongly recommended that all authorized bidders should thoroughly peruse the information provided under the relevant links and take appropriate action. This will prevent hiccups and minimize teething problems during the use of NIC Portal.</p> <p>Please go through the NIC Portal Link for "Bidders Manual Kit" (<a href="https://etender.up.nic.in/nicgep/app?page=BiddersManualKit&amp;service=page">https://etender.up.nic.in/nicgep/app?page=BiddersManualKit&amp;service=page</a>) and go through the instructions carefully for online bid submission.</p>

## Section 4. Bidding Forms- Technical Proposal

### Checklist of Required Forms

This Checklist shall be filled in and submitted by the bidder along with the Technical Bid. Except Form 1 given in Section 5 (to be completed and submitted by the Bidder in the Financial Bid) all other documents/ forms duly filled and complete in all respect are to be submitted by the Bidder in the Technical Bid.

S. No.	Document	Attached? (Yes/ No)	For Official Use
1.	Tender Fee		
2.	List of Consortium Members and Subcontractor(s) (as applicable) as per the format prescribed in Form 1 given in Section 4		
3.	Bidder Information as per the format prescribed in Form 2 given in Section 4		
4.	Project Implementation Plan as per format provided in Form 3 given in Section 4		
5.	Curriculum Vitae of key personnel as per format provided in Form 4 and Form 5 given in Section 4		
6.	Bid Security in the form of Demand Draft or Bank Guarantee as per format prescribed in Form 6 given in Section 4		
7.	Covering Letter for Submission of Bid by Sole Bidder / Lead Consortium Member as per format prescribed in Form 7 given in Section 4		
8.	Consortium Agreement Format entered amongst all Members of the Bidding Consortium as per format prescribed in Form 8 given in Section 4		
9.	Power of Attorney by each Consortium Member in favour of Lead Consortium Member as per format prescribed in Form 9 given in Section 4		
10.	Power of Attorney by Lead Consortium Member/ Sole Bidder authorizing an Individual Designated Representative for the Consortium/ Bidder as per the format prescribed in Form 10 given in Section 4		
11.	Letter of Consent by each Consortium Member reviewing each element of the Bid as per format prescribed in Form 11 given in Section 4		

S. No.	Document	Attached? (Yes/ No)	For Official Use
12.	<p><b>For Lead Member in case of Consortium Bidding / Sole Bidder Experience [Refer Clause 8.1 in Section 2]:</b></p> <ul style="list-style-type: none"> <li>i. References along with requisite contract/ Purchase Order (PO)/ Work Order (WO). The references should indicate client name, scope of work, Project start date (as per the format prescribed in Form 13 given in Section 4);</li> <li>ii. Documentary evidence of Project completion such as client completion certificate, proof of payment received and client certificate of delivery of material, proof of asset capitalized in books of accounts (as applicable)/ and similar proofs along with contact details of the</li> </ul>		
13.1	<p><b>For System Integration Experience [Refer Clause 8.1 and 8.2 D1-D2 in Section 2]:</b></p> <ul style="list-style-type: none"> <li>i. References along with requisite contract/ Purchase Order (PO)/ Work Order (WO). The references should indicate client name, scope of work, Project start date (as per the format prescribed in Form 13 given in Section 4);</li> <li>ii. Documentary evidence of completion of the Project or completion of Go-Live status (i.e., Go-live certificate, UAT testing certificate etc.) or other documentary evidence indicating completion (e.g., proof of payment received and client certificate for supply of material or similar proofs) along with contact details of the client;</li> <li>iii. Client certificate and other documentation for implementation performance/ operation.</li> <li>iv. Agreement entered with the sole bidder / lead bidder (as per format prescribed in Form 23 of section 4)</li> </ul>		

S. No.	Document	Attached? (Yes/ No)	For Official Use
13.2	<p><b>For Meter Manufacturer Eligibility [Refer Clause 8.2 A1-A4 in Section 2]:</b></p> <ul style="list-style-type: none"> <li>i. References along with requisite contract/ Purchase Order (PO)/ Work Order (WO). The references should indicate client name, scope of work, Project start date (as per the format prescribed in Form 14);</li> <li>ii. Documentary evidence of completion of the Project or other documentary evidence indicating completion of supply (e.g. proof of payment received/ proof of asset capitalized in books of accounts (as applicable) and client certificate for supply of material or similar proofs) along with contact details of the client;</li> <li>iii. Client certificate and other documentation for implementation performance/ operation</li> <li>iv. A valid registration certificate of manufacturing unit along with Self-declaration by manufacturer and factory license certificate for requisite facilities.</li> <li>v. A valid ISO certificate on or before the date of submission of the bid.</li> <li>vi. A valid registration certificate mentioning issue/renewal/expiry date.</li> <li>vii. A MAF signed on the letterhead of the Smart Meter manufacturer, addressed to the Sole/ Lead Bidder (as per the format prescribed in Form 22).</li> <li>viii. Agreement entered with the sole bidder / lead bidder (as per format prescribed in Form 23 of section 4)</li> </ul>		
13.3	<p><b>For Head End System (HES) solution provider Eligibility [Refer Clause 8.2 B1 in Section 2]:</b></p> <ul style="list-style-type: none"> <li>i. References along with requisite contract/ Purchase Order (PO)/ Work Order (WO). The references should indicate client name, scope of work, Project start date (as per the format prescribed in Form 13 given in Section 4);</li> <li>ii. Client certificate/ report issued by Client / MDMS OEM / solution provider and other documentation for implementation performance/ operation.</li> <li>iii. A MAF signed on the letterhead of the HES solution provider, addressed to the Sole/ Lead Bidder (as per the format prescribed in Form 22).</li> <li>iv. Agreement entered with the sole bidder / lead bidder (as per format prescribed in Form 23 of section 4)</li> </ul>		

S. No.	Document	Attached? (Yes/ No)	For Official Use
13.4	<p><b>For Meter Data Management System (MDMS) solution provider Eligibility [Refer Clause 8.2 C1-C3 in Section 2]:</b></p> <ul style="list-style-type: none"> <li>i. References along with requisite contract/ Purchase Order (PO)/ Work Order (WO). The references should indicate client name, scope of work, Project start date (as per the format prescribed in Form 13 given in Section 4);</li> <li>ii. Documentary evidence of completion of the Project or completion of Go-live status (i.e., Go-live certificate, UAT testing certificate etc.) of the respective project as per the definition of Go-Live/ UAT specified therein or other documentary evidence indicating completion (e.g., proof of payment received/ proof of asset capitalized in books of accounts (as applicable) and client certificate for supply of material or similar proofs) along with contact details of the client</li> <li>iii. Client certificate and other documentation for implementation performance/ operation.</li> <li>iv. A valid ISO certificate or CMMi certificate on or before the date of submission.</li> <li>v. A MAF signed on the letterhead of the MDMS solution provider, addressed to the Sole/ Lead Bidder (as per the format prescribed in Form 22).</li> <li>vi. Agreement entered with the sole bidder / lead bidder (as per format prescribed in Form 23 of section 4)</li> </ul>		
13.5	<p><b>For RF Solution Provider Eligibility [Refer Clause 8.2 E1-E3 in Section 2]:</b></p> <ul style="list-style-type: none"> <li>i. Certificate of Incorporation and Registration certificate along with Memorandum &amp; Articles of Association. Copy of valid Licenses (In case of RF, Valid certificate issued by Wireless Planning &amp; Coordination (WPC) Wing of the Ministry of Communications, GOI</li> <li>ii. References along with requisite contract/ PO/ WO. The references should indicate client name, scope of work, project start date and date of completion of installation. Certificate from the client on successful implementation of the project.</li> <li>iii. Signed agreements/ MoUs for integration of NIC module or Certificate of successful integration.</li> <li>iv. A MAF signed on the letterhead of the RF solution provider, addressed to the Sole/ Lead Bidder (as per the format prescribed in Form 22).</li> </ul>		



S. No.	Document	Attached? (Yes/ No)	For Official Use
	v. Agreement entered with the sole bidder / lead bidder (as per format prescribed in Form 23 of section 4)		
14.	<b>For Financial Strength [Refer Clause 8.1 in Section 2]:</b> Audited Annual financial statements, Balance Sheet and P&L Account of all Consortium Members/ Sole Bidder for the respective Financial Years as per the format prescribed in Form 12 given in Section 4		
15.	List of Material and Services as per format provided in Form 14 given in Section 4		
16.	Table of Compliance as per format provided in Form 15 given in Section 4		
17.	Format for Technical & Financial Requirement- Relationship & Details of Equity Shareholding (Form 16)		
18.	Authorization from Parent / Affiliate of Sole Bidder / Member of Bidding Consortium whose technical / financial capability has been used by the Sole Bidder / Member of Bidding Consortium (Form 17).		
19.	Format of Undertaking by Technically/ Financially Evaluated Entity(ies) OR Undertaking from the Ultimate Parent Company. for total equity investment commitment, in the prescribed format in Form 18, to meet any shortfall in the equity investment by the Selected Bidder in the SPV.		
20.	Formats for Board Resolutions (Form 19 of section 4)		
21.	Copy of this RFP with sign and official seal on every page		
22.	Pre-Contract Integrity Pact as per Form 20 given in Section 4		
23.	Data Requirement Sheet as per Form 21 given in Section 4		
24.	Valid Empanelment certificate of the sole/ lead bidder for the proposed solution, issued by REC / committee constituted thereby		

### **Form 1: List of Consortium Members/ Sub-Contractor(s)**

- [The Bidder shall identify below the Consortium Members/ Sub-contractor(s) for major Project items. For sub-contractor a Letter of Intent must be provided.]

<b>Major Project Item</b>	<b>Proposed Consortium Member / Sub-Contractor(s)</b>	<b>Nationality</b>
<b>Meter Manufacturer</b>		
<b>Communication Provider</b>		
<b>System Integrator</b>		
<b>MDM Provider</b>		
<b>HES Provider</b>		
<b>Cloud Service Provider / Managed Service Provider</b>		
<b>RF Solution Provider (if any)</b>		
<b>[Other] (if any)</b>		

## Form 2: Bidder Information

*[Sole Bidder/ all Consortium Members must provide all documents required to prove/ substantiate its Eligibility as required in Eligibility Criteria Clause 4 in section 2 for each Consortium Member]*

S. No.	Information Requirement	Details
1	Company Name and Details	
2	Address of its place of business in India	
3	List of board of directors or regulating/controlling body	
4	Attested copy of Certificate of Registration/ Incorporation issued by the Registrar of Companies	
5	Memorandum and Articles of Association or document constituting the company and regulating its affairs	
6	Certificate of Commencement of Business issued by the Registrar of Companies	
7	Copy of the Goods and Services Tax (GST) Registration Certificate	
8	Provident Fund (PF) Certificate indicating PF Code	
9	Copy of Permanent Account Number (PAN) Card	
10	Copy of the Goods and Services Tax (GST) Registration Certificate	
11	Audited annual financial statements and financial Net worth for the last three years	
12	Any other papers or documents required by <b>MVVNL</b> at a later stage or in future	

---

### **Form 3: Project Implementation Plan**

*The Bidder shall submit a preliminary Project implementation plan along with the Bid which shall include at least the following activities:*

- a) Understanding of **MVVNL** and its requirement with respect to Project implementation;*
- b) Overall system architecture and system philosophy capable of scale-up;*
- c) Details of proposed methodology;*
- d) Schematic Diagram of Proposed System Configuration*
- e) An approach paper documenting the interfaces for integration with existing and future applications based on the information provided by **MVVNL***
- f) Project team structure;*
- g) Line of Credit / Source of funding and supporting documents;*
- h) Governance Framework;*
- i) Resource planning and estimation;*
- j) Risk planning;*
- k) Quality Assurance Program;*
- l) Data Privacy Approach;*
- m) Cyber Security Approach;*
- n) Site Survey;*
- o) Installation & Field update schedule;*
- p) Repair and Maintenance Schedule including details on Spares Management;*
- q) Training schedule;*

## Form 4: Bidder's Representative and Key Personnel

[Bidders should provide the names and details of the suitably qualified Contractor's Representative and Key Personnel to perform the AMISP Contract. The data on their experience should be supplied using the Form 5 given in Section 4 below for each candidate.]

1.	<b>Title of position:</b> Project Manager	
	<b>Name of candidate:</b>	
	<b>Duration of appointment:</b>	[insert the whole period (start and end dates) for which this position will be engaged]
	<b>Time commitment: for this position:</b>	[insert the number of days/week/months/ that has been scheduled for this position]
	<b>Expected time schedule for this position:</b>	[insert the expected time schedule for this position (e.g., attach high level Gantt chart)]
2.	<b>Title of position:</b> [System Integration Specialist]	
	<b>Name of candidate:</b>	
	<b>Duration of appointment:</b>	[insert the whole period (start and end dates) for which this position will be engaged]
	<b>Time commitment: for this position:</b>	[insert the number of days/week/months/ that has been scheduled for this position]
	<b>Expected time schedule for this position:</b>	[insert the expected time schedule for this position (e.g., attach high level Gantt chart)]
3.	<b>Title of position:</b> [Cyber Security Specialist]	
	<b>Name of candidate:</b>	
	<b>Duration of appointment:</b>	[insert the whole period (start and end dates) for which this position will be engaged]
	<b>Time commitment: for this position:</b>	[insert the number of days/week/months/ that has been scheduled for this position]
	<b>Expected time schedule for this position:</b>	[insert the expected time schedule for this position (e.g., attach high level Gantt chart)]
4.	<b>Title of position:</b> [Communication Technology Specialist]	
	<b>Name of candidate:</b>	
	<b>Duration of appointment:</b>	[insert the whole period (start and end dates) for which this position will be engaged]
	<b>Time commitment: for this position:</b>	[insert the number of days/week/months/ that has been scheduled for this position]
	<b>Expected time schedule for this position:</b>	[insert the expected time schedule for this position (e.g., attach high level Gantt chart)]

## Form 5: Resume and Declaration

<b>Name of Bidder:</b>
------------------------

<b>Position [#1]: [title of position]</b>		
<b>Personnel information</b>	<b>Name:</b>	<b>Date of birth:</b>
	<b>Address:</b>	<b>E-mail:</b>
	<b>Professional qualifications:</b>	
	<b>Academic qualifications:</b>	
	<b>Language proficiency: [language and levels of speaking, reading and writing skills]</b>	
<b>Details</b>		
	<b>Address of employer:</b>	
	<b>Telephone:</b>	<b>Contact (manager / personnel officer):</b>
	<b>Fax:</b>	
	<b>Job title:</b>	<b>Years with present employer:</b>

Summarize professional experience in reverse chronological order. Indicate technical and managerial experience relevant to the Project.

Project	Role	Duration of involvement	Relevant experience
<i>[main project details]</i>	<i>[role and responsibilities on the project]</i>	<i>[time in role]</i>	<i>[describe the experience relevant to this position]</i>

### Declaration

I, the undersigned *[insert either "Contractor's Representative" or "Key Personnel" as applicable]*, certify that to the best of my knowledge and belief, the information contained in this Form 5 correctly describes myself, my qualifications, and my experience.

I confirm that I am available as certified in the following table and throughout the expected time schedule for this position as provided in the Bid:

Commitment	Details
<b>Commitment to duration of contract:</b>	<i>[insert period (start and end dates) for which this Contractor's Representative or Key Personnel is available to work on this contract]</i>

<b>Time commitment:</b>	<i>[insert period (start and end dates) for which this Contractor's Representative or Key Personnel is available to work on this contract]</i>
-------------------------	--

I understand that any misrepresentation or omission in this Form may:

- (a) be taken into consideration during Bid evaluation;
- (b) result in my disqualification from participating in the Bid;
- (c) result in my dismissal from the contract.

**Name of Contractor's Representative or Key Personnel:** *[insert name]*

Signature: \_\_\_\_\_

Date: (day month year): \_\_\_\_\_

**Countersignature of authorized representative of the Bidder:**

Signature: \_\_\_\_\_

**Date: (day month year):** \_\_\_\_\_

## **Form 6: Format of Bank Guarantee for Bid Security**

*[To be on non-judicial stamp paper of Rupees One Hundred Only (INR 100/-) or appropriate value as per Stamp Act relevant to place of execution, duly signed on each page. Foreign entities submitting Bid are required to follow the applicable law in their country]*

Reference No. .... Bank Guarantee No. .... Dated:  
.....

To:

[MVVNL]

[Address]

Dear Sir/ Madam,

WHEREAS..... [Insert name of the Sole Bidder/Lead Consortium Member] with address ..... [Insert address of Sole Bidder /Lead Consortium Member] having its registered office at ..... [Insert address of the Sole Bidder /Lead Consortium Member] (Hereinafter, the “Bidder”) wishes to participate in Tender No. [Tender Details] (the “RFP”) issued by [MVVNL] (hereinafter, the “MVVNL”) for Appointment of AMISP for Smart Prepaid Metering on DBFOOT basis.

And WHEREAS a Bank Guarantee for [Amount] valid [Date] is required to be submitted by the Bidder along with the RFP.

We, .....[Insert name of the Bank and address of the Branch giving the Bank Guarantee] having our registered office at .....[Insert address of the registered office of the Bank] hereby give this Bank Guarantee No. ....[Insert Bank Guarantee number] dated .....[Insert the date of the Bank Guarantee], and hereby agree unequivocally and unconditionally to pay immediately on demand in writing from the [MVVNL] any officer authorized by it in this behalf any amount not exceeding [Amount] to the said [MVVNL] on behalf of the Bidder.

We ..... [Insert name of the Bank] also agree that withdrawal of the Bid or part thereof by the Bidder within its validity or non-submission of Performance Security by the Bidder within the stipulated time of the Letter of Award to the Bidder or any violation to the relevant terms stipulated in the RFP would constitute a default on the part of the Bidder and that this Bank Guarantee is liable to be invoked and encashed within its validity by the [MVVNL] in case of any occurrence of a default on the part of the Bidder and that the amount is liable to be forfeited by the [MVVNL].

This Guarantee shall be valid and binding on this Bank up to and inclusive of ..... [Insert the date of validity of the Bank] and shall not be terminable by notice or by Guarantor change in the constitution of the Bank or the firm of the Bidder Or by any reason whatsoever and our liability hereunder shall not be impaired or discharged by any extension of time or variations or alternations made, given, conceded with or without our knowledge or consent by or between the Bidder and the [MVVNL].

NOTWITHSTANDING anything contained hereinbefore, our liability under this guarantee is restricted to [Amount]. Our Guarantee shall remain in force till [Date]. Unless demands or claims under this Bank Guarantee are made to us in writing on or before [Date], all rights of the Beneficiary



under this Bank Guarantee shall be forfeited, and we shall be released and discharged from all liabilities there under.

<i>[Insert the address of the Bank with complete postal branch code, telephone and fax numbers, and official round seal of the Bank]</i>	<i>[Insert signature of the Bank's Authorized Signatory]</i>
<i>Attested</i>	
..... [Signature] (Notary Public)	
Place: .....	Date: .....

#### **INSTRUCTIONS FOR SUBMITTING BANK GUARANTEE**

1. Bank Guarantee to be executed on non-judicial stamp paper of appropriate value as per Stamp Act relevant to place of execution. Foreign entities submitting Bids are required to follow the applicable law in their country.
2. The Bank Guarantee by Bidder shall be given from any Scheduled Commercial Bank.
3. The full address along with the Telex/Fax No. and e-mail address of the issuing bank to be mentioned.

## **Form 7: Format of Covering Letter by Sole bidder/ Lead Consortium Member**

*[Covering Letter shall be on the official letterhead of the Sole bidder/ Lead Consortium Member of the Bidding Consortium]*

[Reference No.]

From:

[Address of the Lead Consortium Member/ Sole Bidder]

[Telephone No., Fax No., Email]

[Date]

To:

[MVVNL]

[Address]

**Sub: Bid for Appointment of AMISP for Smart Prepaid Metering on DBFOOT basis**

*Ref: [Tender Details]*

Dear Sir/ Madam,

We, the undersigned ..... *[Insert name of the Lead Consortium Member/ Sole Bidder]* having read, examined and understood in detail the RFP for Appointment of AMISP for Smart Prepaid Metering on DBFOOT basis hereby submit our Bid comprising of Technical and Financial Bids.

1. We give our unconditional acceptance to the RFP including but not limited to all its instructions, terms and conditions, and formats attached thereto, issued by **MVVNL**, as amended. In token of our acceptance to the RFP, the same have been initialed by us and enclosed to the Bid. We shall ensure that our Consortium shall execute such requirements as per the provisions of the RFP and provisions of such RFP shall be binding on us.

### **2. Fulfilment of Eligibility**

We undertake that we fulfil the Eligibility Criteria stipulated in the RFP and fulfil all the eligibility requirements as the Lead Consortium Member/ Sole Bidder as outlined in the RFP.

We hereby confirm that in accordance with Clause 7 of Section 2 of the RFP, we are herewith submitting legally binding undertaking supported by a board resolution from the .....*[insert name of Technically Evaluated Entity and/or Financially Evaluated Entity or its Ultimate Parent Company, as the case may be]* that all the equity investment obligations of ..... *[insert name of the Sole Bidder/ Lead Consortium Member]* shall be deemed to be equity investment obligations of the ..... *[insert name of Technically Evaluated Entity and/or Financially Evaluated Entity or its Ultimate Parent Company, as the ease may be]* and in the event of any default by..... *[insert name of the Sole Bidder/ / Lead Consortium*

*Member], the same shall be met by ..... [insert name of Technically Evaluated Entity and/or Financially Evaluated Entity or its Ultimate Parent Company, as the case may be].  
[To be inserted only in ease the Bidder has sought qualification on the basis of technical and financial capability of its Affiliate(s) and/or its Parent]*

### **3. Bid Security**

We have enclosed a Bid Security of [Amount] in the form of a Bank Guarantee No. ....  
*[Insert Bank Guarantee Number]* (OR Demand Draft) dated .....*[Insert date of the Bank Guarantee]* as per Form 6 given in Section 4 from .....*[Insert name of Bank providing Bid Bond]* and valid up to [Date].

### **4. No Deviation**

We have submitted our Financial Bid strictly as per terms and formats of the RFP, without any deviations, conditions and without mentioning any assumptions or notes for the Financial Bid in the said format.

### **5. Acceptance**

We hereby unconditionally and irrevocably agree and accept that the decision made by **MVVNL** in respect of any matter regarding or arising out of the RFP shall be binding on us. We hereby expressly waive any and all claims in respect of Bid process.

We confirm that there are no litigations or disputes against us, which materially affect our ability to fulfil our obligations with regard to fulfilling our obligations as per the RFP.

### **6. Familiarity with Relevant Indian Laws and Regulations**

We confirm that we have studied the provisions of the relevant Indian laws and regulations as required to enable us to submit this Bid and execute the RFP Documents, in the event of our selection as Selected Bidder. We further undertake and agree that all such factors as mentioned in the AMISP Contract have been fully examined and considered while submitting the Bid.

### **7. Compliance with applicable laws/ guidelines for public procurement in India**

We confirm that we shall adhere to applicable laws for public procurement in India including the guidelines issued in Order No. F/No.6/18/2019-PPD by Ministry of Finance, Department of Expenditure, Public Procurement Division dated 23 July 2020, Order No No.9/16/2016-Trans-Part (2) dated 18 November 2020, latest Government of India Guidelines for Make in India, Domestically manufactured products, Atmanirbhar Bharat and circulars DIPP Office Memorandum No. P-45021/2/2017-PP (BE-II) date:16th Sept. 2020, MeitY Circular No.1(10)/2017-CLES dated 06.12.2019 and Order No. 11/05/2018-Coord. by the Ministry of Power dated 17 September 2020 including any amendments or modifications to the same from time to time.

### **8. Contact Person**

Details of the contact person representing our Bidding Consortium/ Sole Bidder (registered Company) supported by the Power of Attorney prescribed in Form 10 given in Section 4 of the RFP are furnished as under:

Name: .....

Designation: .....

Company: .....

Address: .....

Mobile: .....

Phone: .....

Fax: .....

Email: .....

1. We are submitting herewith the Technical Bid containing duly signed formats, both in electronic and physical forms, (duly attested) as desired by you in the RFP for your consideration.
2. We are also submitting herewith the Financial Bid in electronic form only, as per the terms and conditions in the RFP.
9. It is confirmed that our Bid is consistent with all the requirements of submission as stated in the RFP and subsequent communications from **MVVNL**.
10. The information submitted in our Bid is complete, strictly as per the requirements stipulated in the RFP and is correct to the best of our knowledge and understanding. We would be solely responsible for any errors or omissions in our Bid.
11. We confirm that all the terms and conditions of our Bid are valid for acceptance for a period of 1 (one) year from the Bid Submission Deadline.
12. We confirm that we have not taken any material deviation so as to be deemed non-responsive with respect to the provisions stipulated in the RFP.
13. We confirm that no order/ ruling has been passed by any Competent Court or Appropriate Commission against us or any of our Consortium Members or in the preceding 1 (one) year from the Bid Submission Deadline for breach of any contract and that the Bid Security submitted by us or any of our Consortium Members has not been forfeited, either partly or wholly, in any bid process in the preceding 1 (one) year from the Bid Submission Deadline.
14. We confirm that we are not currently blacklisted by any Govt. Organization or Regulatory Agencies or Govt. undertaking.
15. We confirm that we are not currently banned/ debarred by the [Name of the **MVVNL**] or any of its subsidiaries/ holding company.
16. We are registered/ exempt from registering in accordance with applicable laws  
[Evidence of valid registration by the Competent Authority shall be attached if applicable]

Dated the ..... [Insert date of the month] day of ..... [Insert month, year] at ..... [Insert place].

Thanking you,

Yours Sincerely,

[Insert Signature here]

[Insert Name here]

[Insert Designation here]

## **Form 8: Format of Consortium Agreement to be entered amongst all Members of a Bidding Consortium**

*[To be on non-judicial stamp paper of Rupees One Hundred Only (INR 100/-) or appropriate value as per Stamp Act relevant to place of execution, duly signed on each page. Foreign entities submitting Bid are required to follow the applicable law in their country.]*

### FORM OF CONSORTIUM AGREEMENT BETWEEN

M/s....., M/s. ...., M/s. ....,  
AND M/s. .... for bidding for Tender No. [Tender Details] (the “RFP”) dated [Date] as per its Clause 4.3.2

1. **THIS Consortium Agreement** (hereinafter referred to as “Agreement”) executed on this ..... [date] day of ..... [month], ..... [year] between
2. M/s. ...., a company incorporated under the laws of ..... and having its Registered Office at ....., (hereinafter called "**Party 1**," or "**Lead Consortium Member**" which expression shall include its successors, executors and permitted assigns);
3. M/s. ...., a company incorporated under the laws of ..... and having its Registered Office at ....., (hereinafter called "**Party 2**," which expression shall include its successors, executors and permitted assigns);
4. M/s. ...., a company incorporated under the laws of ..... and having its Registered Office at ....., (hereinafter called "**Party 3**," which expression shall include its successors, executors and permitted assigns);
5. M/s. ...., a company incorporated under the laws of ..... and having its Registered Office at ....., (hereinafter called "**Party n**," which expression shall include its successors, executors and permitted assigns);

*[The Bidding Consortium should list the name, address of its registered office and other details of all the Consortium Members above.]*

WHEREAS the Parties abovenamed are entering into this Consortium Agreement for the purpose of submitting the Bid in response to the RFP and in the event of selection as Selected Bidder to comply with the requirements as specified in the RFP and ensure execution of the AMISP Contract as may be required to be entered into with **MVVNL**.

Party 1, Party 2, Party 3, ... and Party n are hereinafter collectively referred to as the “Parties” and individually as a “Party.”

**WHEREAS** the RFP stipulates that the Bidders applying as a Bidding Consortium shall submit a legally enforceable Consortium Agreement in a format specified in the RFP, whereby each Consortium Member undertakes to be liable for its Roles and Responsibilities, provide necessary guarantees and pay required fees as required as per the provisions of the RFP, as specified herein.

**WHEREAS** any capitalized term in this Agreement shall have the meaning ascribed to such term in the RFP document.

**NOW THEREFORE, THIS AGREEMENT WITNESSTH AS UNDER:**

In consideration of the above premises and agreement all the Parties in this Consortium do hereby mutually agree as follows:

1. In consideration of the selection of the Consortium as the Bidding Consortium by **MVVNL**, we the Members of the Consortium and Parties to the Consortium Agreement do hereby unequivocally agree that M/s..... *[Insert name of the Lead Member]*, shall act as the Lead Member as defined in the RFP for self and agent for and on behalf of M/s. ...., M/s. ...., M/s. ...., and M/s. .... *[the names of all the other Members of the Consortium to be filled in here]*.
2. The Lead Consortium Member is hereby authorized by the Members of Consortium and Parties to the Consortium Agreement to bind the Consortium and receive instructions for and on behalf of all Members. The Roles and Responsibilities of all other members shall be as per the **Annexure** to this Agreement.
3. In the event the Consortium is selected pursuant to the Bidding Process, the shareholding of all each of the Consortium Members in the AMISP shall be as under:

S. No.	Name of the Bidding Company/ Member in case of a Bidding Consortium	Name of the Company investing in the equity of the SPV	Relationship with Sole Bidder / Member of the Bidding Consortium	% of equity participation in the SPV
1.	Lead Consortium Members			(Not Less than 51%)
2.	Consortium Member 1			(Not Less than 10%)
3.	Consortium Member 2			(Not Less than 10%)
4.	Consortium Member 3			(Not Less than 10%)
5.	Consortium Member 4			(Not Less than 10%)

\* In case the Bidder proposes to invest through its Affiliate(s) / Parent Company / Ultimate Parent Company, the Bidder shall declare shareholding pattern of such Affiliate(s) / Parent Company / Ultimate Parent Company and provide documentary evidence to demonstrate relationship between the Bidder and the Affiliate(s) / Parent Company / Ultimate Parent Company. These documentary evidence could be, but not limited to, demat account statement(s) / Registrar of Companies' (ROC) certification / share registry book, etc. duly certified by Company Secretary.

\*If % of equity participation of any of the consortium members in the SPV is less than 10% or if any of the consortium members is not willing to be a part of the SPV to be formed, except when the said consortium member is a Central Public Sector Enterprise (CPSE) / Public Sector Undertaking (PSU) or Subsidiary/ Joint Venture of a CPSE/ PSU, the bidder would have to furnish an additional security as per **SCC**.

---

\*If a Central Public Sector Enterprise (CPSE) / Public Sector Undertaking (PSU) or Subsidiary/ Joint Venture of a CPSE/ PSU is either the sole Bidder or a lead member of a Bidding Consortium, then creation of an SPV is not mandatory and in such a case, the bidder shall be exempted from providing an additional security as per SCC.

4. Each Consortium Member undertakes to be individually liable for the performance of its part of the Roles and Responsibilities without in any way limiting the scope of collective liability envisaged in this Agreement in order to meet the requirements and obligations of the RFP. The Lead Consortium Member shall be liable and responsible for ensuring the individual and collective commitment of each of the Members of the Consortium in discharging all their respective Roles and Responsibilities.
5. In case of any breach of any of the commitment as specified under this Agreement by any of the Consortium Members, the Lead Consortium Member of the Consortium shall be liable to meet the obligations as defined under the RFP.
6. Except as specified in the Agreement, it is agreed that sharing of responsibilities as aforesaid and obligations thereto shall not in any way be a limitation of responsibility of the Lead Member under these presents.
7. The Members expressly agree to adhere to all the terms and conditions of the RFP and confirm that we don't have any Conflict of Interest (as defined in the RFP).
8. This Consortium Agreement shall be construed and interpreted in accordance with the Laws of India and Courts at [Place] shall have the exclusive jurisdiction in all matters relating thereto and arising there under.
9. It is hereby agreed that the Lead Consortium Member shall furnish the Bid Security, as stipulated in the RFP, on behalf of the Bidding Consortium.
10. It is hereby agreed that in case of selection of Bidding Consortium as the AMISP, the Parties to this Consortium Agreement do hereby agree that they shall furnish the Performance Security and other commitments to **MVVNL** as stipulated in the RFP and AMISP Contract. The Lead Member shall be responsible for ensuring the submission of the Performance Security and other commitments on behalf of all the Consortium Members.
11. It is further expressly agreed that the Consortium Agreement shall be irrevocable and, for the AMISP, shall remain valid over the term of the Project, unless expressly agreed to the contrary by **MVVNL**.
12. The Lead Consortium Member is authorized and shall be fully responsible for the accuracy and veracity of the representations and information submitted by the Consortium Members respectively from time to time in response to the RFP for the purposes of the Bid. The representation by the Lead Member shall be deemed to be on behalf of and binding on all members of the Consortium.
13. It is expressly understood and agreed between the Members of the Consortium and Parties that the responsibilities and obligations of each of the Members shall be as delineated as annexed hereto as Annexure-A forming integral part of this Agreement. It is further agreed by the Members that

the above sharing of responsibilities and obligations shall not in any way be a limitation of responsibilities and liabilities of the Members, with regards to all matters relating to the execution of the Bid and implementation of the Project envisaged in the RFP Documents.

14. It is clearly agreed that the Lead Consortium Member shall ensure performance indicated in the RFP. In the event one or more Consortium Members fail to perform its/ their respective obligations, the same shall be deemed to be a default by all the Consortium Members.

15. It is hereby expressly agreed between the Parties to this Consortium Agreement that neither Party shall assign or delegate or subcontract its rights, duties or obligations under this Agreement to any person or entity except with prior written consent of **MVVNL**.

16. This Consortium Agreement:

- a) has been duly executed and delivered on behalf of each Party hereto and constitutes the legal, valid, binding and enforceable obligation of each such Party;
- b) sets forth the entire understanding of the Parties hereto with respect to the subject matter hereof; and
- c) may not be amended or modified except in writing signed by each of the Parties and with prior written consent of **MVVNL**.

Common Seal of ..... has been affixed in my/ our presence pursuant to Board Resolution dated .....	For M/s. .... (Party 1) <i>[Signature of Authorized Representative]</i> ..... <i>[Name of the Authorized Representative]</i> <i>[Designation of the Authorized Representative]</i>
--	--

Witness 1

[Signature of Witness 1]

.....

Name:

Designation  Witness 2  [Signature of Witness 2] ..... Name: Designation:	
--	--

..

N. Common Seal of ..... has been affixed in my/ our presence pursuant to Board Resolution dated .....	For M/s. .... (Party N) <i>[Signature of Authorized Representative]</i> ..... <i>[Name of the Authorized Representative]</i> <i>[Designation of the Authorized Representative]</i>
---	--



<p>N.1. Witness 1</p> <p>[Signature of Witness 1]</p> <p>.....</p> <p>Name:</p> <p>Designation:</p>	<p>N.2. Witness 2</p> <p>[Signature of Witness 1]</p> <p>.....</p> <p>Name:</p> <p>Designation:</p>
---	---

---

**Annexure-A**

Role and Responsibility of each Member of the Consortium:

1. Roles and Responsibilities of the Party 1 (Lead Consortium Member):
2. Roles and Responsibilities of the Party 2
3. Roles and Responsibilities of the Party 3
- .
- .
- N. Roles and Responsibilities of the Party N

## **Form 9: Format of Power of Attorney by Consortium Member in favour of Lead Consortium Member**

*[To be provided by each Consortium Member (other than the Lead Consortium Member) in favor of the Lead Consortium Member]*

**WHEREAS** [M/VVNL] has issued for Tender No. [Tender Details] (the “RFP”) dated [Date] for inviting Bids in respect of Appointment of AMISP for Smart Prepaid Metering on DBFOOT basis (the “Project”) on the terms contained in the RFP;

**WHEREAS** M/s....., M/s. ...., M/s. and M/s. .... [Insert names of all Members of Consortium] the Members of the Consortium are desirous of submitting a Bid in response to the RFP, and if selected, undertaking the responsibility of implementing the Project as per the terms of the RFP;

**WHEREAS** all the Members of the Consortium have agreed under the Consortium Agreement dated ..... (the “Consortium Agreement”), entered into between all the Members and submitted along with the Bid to appoint ..... [Insert the name and address of the Lead Consortium Member] as Lead Consortium Member to represent all the Members of the Consortium for all matters regarding the RFP and the Bid;

**AND WHEREAS** pursuant to the terms of the RFP and the Consortium Agreement, we, the Members of the Consortium hereby designate M/s ..... [Insert name of the Lead Member] as the Lead Consortium Member to represent us in all matters regarding the Bid and the RFP, in the manner stated below:-

Know all men by these presents, we ..... [Insert name and address of the registered office of the Member 1], ..... [Insert name and address of the registered office of the Member 2],....., ..... [Insert name and address of the registered office of the Member n] do hereby constitute, appoint, nominate and authorize ..... [Insert name and registered office address of the Lead Consortium Member], which is one of the Members of the Consortium, to act as the Lead Member and our true and lawful attorney, to do in our name and on our behalf, all such acts, deeds and things necessary in connection with or incidental to submission of Consortium’s Bid in response to the RFP issued by [M/VVNL] including signing and submission of the Bid and all documents related to the Bid as specified in the RFP, including but not limited to undertakings, letters, certificates, acceptances, clarifications, guarantees or any other document, which [M/VVNL] may require us to submit. The aforesaid attorney is further authorized for making representations to [M/VVNL] named in the RFP, and providing information / responses to [M/VVNL], representing us and the Consortium in all matters before [M/VVNL] named in the RFP, and generally dealing with [M/VVNL] named in the RFP in all matters in connection with our Bid, till completion of the bidding process as well as implementation of the Project, if applicable, in accordance with the RFP.

We, as Members of the Consortium, hereby agree to ratify all acts, deeds and things done by our said attorney pursuant to this Power of Attorney and that all acts, deeds and things done by our aforesaid attorney shall be binding on us and shall always be deemed to have been done by us.

All the terms used herein but not defined shall have the meaning ascribed to such terms under the RFP.

We, as Members of the Consortium, hereby agree to ratify all acts, deeds and things done by our said attorney pursuant to this Power of Attorney and that all acts, deeds and things done by our aforesaid attorney shall be binding on us and shall always be deemed to have been done by us.

All the terms used herein but not defined shall have the meaning ascribed to such terms under the RFP.

**Signed by the within named** ..... *[Insert the name of the executant Consortium Member]* **through the hand of Mr./ Ms./ Dr.** ..... **duly authorized by the Board to issue such Power of Attorney dated this** ..... **day of** .....

**Accepted**

.....  
(Signature of Attorney)  
[Insert Name, designation and address of the Attorney]

**Attested**

.....  
(Signature of the executant)  
(Name, designation and address of the executant)  
.....  
Signature and stamp of Notary of the place of execution

**Common seal of** ..... **has been affixed in my/our presence pursuant to Board of Director’s Resolution dated**.....

- 1. **WITNESS1.** ..... **(Signature)**  
Name .....
- 2. **WITNESS2**..... **(Signature)**  
Name .....

**Designation**.....\_\_

**Notes**

- a. *The mode of execution of the power of attorney should be in accordance with the procedure, if any, laid down by the applicable law and the charter documents of the executant(s).*
- b. *In the event, power of attorney has been executed outside India, the same needs to be duly notarized by a notary public of the jurisdiction where it is executed.*
- c. *Also, wherever required, the executant(s) should submit for verification the extract of the charter documents and documents such as a Board resolution / power of attorney, in favor of the person executing this power of attorney for delegation of power hereunder on behalf of the executant(s).*

**Form 10: Format of Power of Attorney by Lead Consortium Member / Sole Bidder authorizing an Individual Designated Representative for the Consortium**

*[To be on non-judicial stamp paper of Rupees One Hundred Only (INR 100/-) or appropriate value as per Stamp Act relevant to place of execution. Foreign companies submitting Bids are required to follow the applicable law in their country.]*

Know all men by these presents, we .....*[Insert name and address of the registered office of the Lead Consortium Member of the Bidding Consortium/ Sole Bidder]* do hereby constitute, appoint, nominate and authorize Mr./Ms. .... *[Insert name and residential address]*, who is presently employed with us and holding the position of ..... as our true and lawful attorney, to do in our name and on our behalf, all such acts, deeds and things necessary in connection with or incidental to submission of our Bid in response to Tender No. [Tender Details] for Appointment of AMISP for Smart Prepaid Metering on DBFOOT basis (the “Project”) issued by [MVVNL], including signing and submission of the Bid and all other documents related to the Bid, including but not limited to undertakings, letters, certificates, acceptances, clarifications, guarantees or any other document which MVVNL may require us to submit. The aforesaid attorney is further authorized for making representations to MVVNL, and providing information / responses to MVVNL, representing us in all matters before MVVNL, and generally dealing with MVVNL in all matters in connection with our Bid till the completion of the bidding process as per the terms of the RFP.

We hereby agree to ratify all acts, deeds and things done by our said attorney pursuant to this Power of Attorney and that all acts, deeds and things done by our aforesaid attorney shall be binding on us and shall always be deemed to have been done by us.

All the terms used herein but not defined shall have the meaning ascribed to such terms under the RFP.

**Signed by the within named** ..... *[Insert the name of the executant company]*  
**through the hand of Mr./ Mrs.** .....**duly authorized by the Board to issue such Power of Attorney dated this** ..... **day of** .....

**Accepted**

..... (Signature of Attorney)  
[Insert Name, designation and address of the Attorney]

**Attested**

.....  
(Signature of the executant)  
(Name, designation and address of the executant)

.....  
Signature and stamp of Notary of the place of execution

**Common seal of** ..... **has been affixed in my/our presence pursuant to Board of Director’s Resolution dated**.....

1. **WITNESS 1.** ..... (Signature)  
**Name** .....  
**Designation**.....

2. **WITNESS 2.** ..... (Signature)  
**Name** .....  
**Designation**.....\_

**Notes:**

- a. *The mode of execution of the power of attorney should be in accordance with the procedure, if any, laid down by the applicable law and the charter documents of the executant(s).*
- b. *In the event, power of attorney has been executed outside India, the same needs to be duly notarized by a notary public of the jurisdiction where it is executed.*
- c. *Also, wherever required, the executant(s) should submit for verification the extract of the charter documents and documents such as a Board resolution / power of attorney, in favour of the person executing this power of attorney for delegation of power hereunder on behalf of the executant(s).*

**Form 11: Format of Letter of Consent by Sole Bidder/ Consortium Member reviewing each element of the Bid**

*[On the letter head of Sole Bidder/ each Member of the Consortium including Lead Member]*

[Reference No.]

From:

[Address of the Lead Consortium Member/ Sole Bidder]

[Telephone No., Fax No., Email]

[Date]

To:

[MVVNL]

[Address]

**Sub: Bid for Appointment of AMISP for Smart Prepaid Metering on DBFOOT basis.**

*Ref: [Tender Details]*

Dear Sir/ Madam,

We, ..... [Insert name of the undersigned Sole Bidder/ Consortium Member] Sole Bidder/ Member of Consortium and Lead by ..... [Insert name of the Lead Consortium Member] have read, examined and understood the RFP and RFP Documents for Appointment of AMISP for Smart Prepaid Metering on DBFOOT basis.

We hereby confirm our concurrence with the RFP including in particular the Bid / and Consortium Agreement submitted by ..... [Insert name of the Sole Bidder/ Lead Consortium Member], in response to the RFP. We confirm that the Bid has been reviewed and each element of the Bid is agreed to including but not limited to the commitment and obligations of our Company.

We hereby confirm that in accordance with Clause 7 of Section 2 of the RFP, we are enclosing legally binding undertaking supported by a board resolution from the ..... [insert name of Technically Evaluated Entity and / or Financially Evaluated Entity or its Ultimate Parent Company, as the case may be] that all the equity investment obligations of ..... [insert name of the Member] shall be deemed to be equity investment obligations of the .....[insert name of Technically Evaluated Entity and / or Financially Evaluated Entity or its Ultimate Parent Company, as the case may be] and in the event of any default..... [insert name of the Member], the same shall be met by..... [insert name of Technically Evaluated Entity and / or Financially Evaluated Entity or its Ultimate Parent Company, as the case may be]. *[Insert if applicable]*

The details of contact person are furnished as under:

- Name :
- Designation :
- Name of the Company :
- Address :
- Phone Nos. :

---

Fax Nos. :

E-mail address :

Dated the ..... day of ..... of 20.....

Thanking you,

Yours faithfully,

.....

*[Signature, Name, Designation of Authorized Signatory of Consortium Member and Company's Seal]*

Business Address:

*[Name and address of principal officer]*



## Form 12: Format of Summary of Audited Financial Statements

< This form needs to be submitted by Sole Bidder/ Lead Consortium Member. In case of an AIF or Foreign Investment Fund using ACI, ACI would be considered as per the certificate issued by statutory auditor (or such other certificate as filed with the regulator in the relevant jurisdiction) not older than 1 (one) month prior to the date of Bid Submission >

[Reference No.]

From:

[Address of the Lead Consortium Member/ Sole Bidder]

[Telephone No., Fax No., Email]

[Date]

To:

[MVVNL]

[Address]

**Sub: Audited Financial Statement for ..... [Insert name of Sole Bidder/Consortium Member].**

Ref: [Tender Details]

Dear Sir/ Madam,

This is to certify that ..... [Insert name of Sole Bidder/Consortium Member] having its Registered Office at ..... [Insert Registered Address of the Consortium Member] are in the business of ..... [Insert briefly the nature of the business], have recorded the following:

NETWORTH FOR LAST THREE FINANCIAL YEARS				
S. No.	Name of Financially Evaluated Entity(ies)	Relationship with Bidder	Financial Year (FY)	Net worth Amount (In Indian Rupees)
1.				
2.				
3.				

Or

ACI FOR PRECEDING FINANCIAL YEAR				
S. No.	Name of Financially Evaluated Entity(ies)	Relationship with Bidder	Financial Year (FY)	ACI Amount (In Indian Rupees)
1.				
2.				
3.				

---

The above Net worth/ ACI are arrived from our Audit Reports for the last three/ preceding<sup>2</sup> financial years duly submitted to the Income Tax Department along with our Audit Reports.

Hence, we certify from the records submitted to us. Thanking you,

Sincerely yours,

Yours Sincerely,

*[Insert Signature here]*

*[Insert Name here]*

*[Insert Designation here]*

Date: [Date]

Place: [Place]

---

<sup>2</sup> In case ACI is used to meet the financial requirements



## Form 14: List of Material and Services

*Please Note: The list is indicative only. This needs to be detailed out and customized by [ AMISP] basis Project requirement*

**Table 1: List of Materials and Services for Smart Meters [Indicative Only. To be defined by AMISP]**

S. No.	Item Description	Country of Origin
<b>1.</b>	<b>Meters (including Communication module/NIC card)</b>	
1.1	Single phase whole current Smart Meter (without Net-Metering) – Consumer Meter	
1.2	Single phase whole current Smart Meter (with Net-Metering) – Consumer Meter	
1.3	Three Phase whole current Smart Meter (without Net-Metering) – Consumer Meter	
1.4	Three Phase whole current Smart Meter (with Net-Metering) – Consumer Meter	
1.5	Three phase LT-CT operated Smart Meter (without Net-Metering) – Consumer Meter	
1.6	Three phase LT-CT operated Smart Meter (with Net-Metering) – Consumer Meter	
1.7	Three phase LT-CT operated Smart Meter (with Net-Metering) – DT Meter	
1.8	Three phase CT/PT operated Smart Meter – Feeder Meter	
1.9	Three phase CT/PT operated Smart Meter – Boundary Meter	
1.10	....	
<b>2.</b>	<b>Mandatory Spares</b>	
2.1	X% of Subtotal 1	
2.2	....	
..	..	
<b>3.</b>	<b>Installation &amp; Commissioning</b>	
3.1	Supply, Installation, Commissioning & Testing & Integration with Existing System (if any)	
3.2	Meter Boxes	
..	..	
<b>4.</b>	<b>Other Requirement</b>	
4.1	Any other product/ services, if required, along with details.	
<b>5.</b>	<b>Communications Hardware</b>	

## Section 4. Technical Proposal –Forms

S. No.	Item Description	Country of Origin
5.1	NIC/ Communication Module (price to be quoted only for sourcing additional quantity if required.	
5.2	Data Concentrator Units/Access points	
<b>6.</b>	<b>Service Cable</b>	
<del>6.1</del>	<del>SMC Main Service Distribution Box (MSDB)</del>	
<del>6.2</del>	<del>4 core 35 mm<sup>2</sup> XLPE Cable [(@ 2 meter per connection]</del>	
6.3	2C*6 mm <sup>2</sup> Cable,1.1k V Grade, Un-Armored, XLPE Insulated Stranded Conductor FRLS type for pole mounted for Single Phase [(@ 20 meter per connection]	
6.4	4C*16 mm <sup>2</sup> Cable,1.1k V Grade, Armored, XLPE Insulated Stranded Conductor FRLS type for pole mounted for Three Phase [(@ 20 meter per connection]	
..	..	
<b>7.</b>	<b>DT Cable</b>	
7.1	..	
....	.....	

**Table 2: List of Materials and Services for Software [Indicative Only. To be defined by AMISP]**

S. No.	Item Description	Country of Origin
<b>1.</b>	<b>Application Software</b>	
1.1	Meter Data Acquisition Software (MDAS)/Head End System (HES)	
1.2	Meter data management (MDM) .....	
1.3	....	
..	...	
<b>2.</b>	<b>Data Archiving Software</b>	
2.1	Data Archiving and SAN management software	
2.2	....	
..	..	
<b>3.</b>	<b>Network Management Software</b>	
3.1	Centralized network management software along with patch management & identity management	
3.2	Antivirus software for all machines in Network Operation cum Monitoring Center	
3.3	Access control software with single sign on feature	

## Section 4. Technical Proposal –Forms

S. No.	Item Description	Country of Origin
...	....	
..	..	
<b>4.</b>	<b>Installation &amp; Commissioning</b>	
4.1	Supply, Installation, Commissioning & Testing & Integration with Existing System (if any)	
4.2	....	
..	..	
<b>5.</b>	<b>Other Requirement</b>	
5.1	Any other product/ services, if required, along with details.	

**Table 3: List of Materials and Services for Hardware [Indicative Only. To be defined by AMISP]**

S. No.	Item Description	Country of Origin
<b>1.</b>	<b>Hardware for Network Operation cum Monitoring Centre</b>	
1.1	Workstation consoles	
1.2	Firewall	
1.3	Router	
..	..	
<b>2.</b>	<b>Mandatory Spares</b>	
2.1	X% of Subtotal 1	
2.2	....	
..	..	
<b>3.</b>	<b>Installation &amp; Commissioning</b>	
3.1	Supply, Installation, Commissioning & Testing & Integration with Existing System (if any)	
3.2	....	
..	..	
<b>4.</b>	<b>Other Requirement</b>	
4.1	Any other product/ services, if required, along with details.	

**Table 4: List of Materials and Services for Training [Indicative Only. To be defined by AMISP]**

S. No.	Item Description	Country of Origin
<b>1.</b>	<b>Training at Site</b>	
1.1	Smart Meter & Communication network	
1.2	HES & MDM, Protocol, Database, User Interface, Display and Application software	
1.3	Computer System Hardware & Software	
1.4	....	
..	..	

**Table 5: List of Materials and Services for Operation and Maintenance [Indicative Only. To be defined by AMISP]**

S. No.	Item Description	Country of Origin
<b>1.</b>	<b>Operation and Maintenance</b>	
1.1	Operation of complete system (during warranty period) including providing communication link to Network Operation cum Monitoring Center as well as network connectivity for Cellular services for AMI System	
1.2	Maintenance of complete System during AMI operations period	
1.3	....	

**Table 6: List of Materials and Services for Infrastructure for Recharge through Feature Phones/ Offline Channels [Indicative Only. To be defined by AMISP]**

S. No.	Item Description	Country of Origin
<b>1.</b>	<b>Infrastructure for Recharge</b>	
1.1	Retail distribution centres	
1.2	Workstation Consoles	
1.3	Computer System	
..	..	

**Table 7: List of Materials and Services for Consumer Engagement Activities [Indicative Only. To be defined by AMISP]**

S. No.	Item Description	Country of Origin
<b>1.</b>	<b>Consumer Engagement Activities</b>	
1.1	Consumer engagement plan	
1.2	Communication and media plan	
1.3	..	
<b>2</b>	<b>Implementation support for consumer engagement activities as per point 1</b>	
2.1	Knowledge Materials/ Tools/ Brochures	
2.2	Social media campaigns	
2.3	Press release/ ads/ newsletters	
2.4	Videos/ Film	
2.5	Consumer Surveys	
..	..	



## **Form 15: Table of Compliance**

---

The Bidder shall submit 'Clause by Clause' compliance to the RFP document including the technical specifications and functional requirements (with amendments, if any) as per the format prescribed in Form 15

. The Bidder shall annotate the Table of Contents of each section to provide a high-level summary of compliance status. In all cases, the following symbols, and no others shall be used:

---

- **C - Bid complies with all requirements in the adjacent paragraph.**
- **A - Bid is not compliant with the requirements in the adjacent paragraph, but a functional alternative is proposed.**
- **X - Bid takes exception to the requirements of the adjacent paragraph and no functional alternative is proposed.**

Only one symbol shall be assigned to paragraph and shall indicate the worst-case level of compliance for that paragraph. This annotation may be handwritten.

The Bidder shall also underline, on the compliance copy, all requirements to which exceptions have been taken (X) or to which alternatives have been proposed (A).

Each alternative shall be clearly and explicitly described. Such descriptions shall use the same paragraph numbering as the bid document sections addressed by the alternatives. All alternative descriptions shall be in one contiguous section of the bidder's proposal, preferably in the same volume, and titled "Alternatives." A separate section titled "Exceptions" shall also be provided containing any discussion or explanation chooses to provide concerning exceptions taken. Alternatives which do not substantially comply with the intent of the Bid documents will be considered exceptions.

Any clause which is not included in this compliance table shall be treated as "fully complied" or C.

The **MVVNL** will assess the merits of each alternative and exception and will be the sole judge as to their acceptance.

## Form 16: Format for Technical & Financial Requirement- Relationship & Details of Equity Shareholding

[Reference No.]

From:

[Address of the Lead Consortium Member/ Sole Bidder]

[Telephone No., Fax No., Email]

[Date]

To:

[MVVNL]

[Address]

**Sub: Bid for Appointment of AMISP for Smart Prepaid Metering on DBFOOT basis**

*Ref: [Tender Details]*

Dear Sir/ Madam,

We certify that M/s .....[insert name of the Sole Bidder / Consortium Members] have considered the technical and financial capability of its Parent and / or Affiliates, for the purpose of meeting Qualification Requirements as per the instructions provided in the RFP. The name of Parent and / or Affiliate, nature of relationship(s) with such Parent and / or Affiliate and details of equity holding are as follows:

Name of Company whose credentials considered	Type of credentials considered (technical and / or financial)	Relationship with Sole Bidder / Consortium Member (Parent / Affiliate)	Details of equity shareholding (refer notes below)
Company 1			
.....			
.....			
.....			
.....			

NOTES:

- i) In case of Parent, the equity holding of the Parent in the Sole Bidder / Member of the Bidding Consortium, including the Lead Member of the Consortium, need to be specified,
- ii) In case of Affiliate under direct control of Bidder, the equity holding of the Sole Bidder / Member of the Bidding Consortium, including the Lead Member of the Consortium in the Affiliate, needs to be specified.

## Section 4. Technical Proposal –Forms

- 
- iii) In case of Affiliate under common control of Parent, the equity holding of the Parent in the Affiliate of the Sole Bidder / Member of the Bidding Consortium, including the Lead Member of the Consortium, needs to be specified.
  - iv) Relationship Of Parent / Affiliate with Sole Bidder / Member Of Consortium to be at the most seven (7) days prior to the Bid Deadline (as per Clause 7 of Section 2 of the RFP)
- 

Yours faithfully

.....  
 (Signature and name of the authorized signatory of the Company and stamp)

Name: .....

Date: .....

Place: .....

.....  
 (Signature and Stamp of statutory Auditors of Sole Bidder / each Member of Bidding Consortium)

Name: .....

Date: .....

Place: .....

Date: .....

**Form 17: Authorization from Parent / Affiliate of Sole Bidder / Member of Bidding Consortium Whose Technical / Financial Capabilities has been used by the Sole Bidder / Member of Bidding Consortium**

[On the Letter Head of the Parent /Affiliate]

[Reference No.]

From:

[Address of the Parent / Affiliate of Bidder / Member of Bidding Consortium]

[Telephone No., Fax No., Email]

[Date]

To:

[MVVNL]

[Address]

Dear Sir,

**Sub: Bid for Appointment of AMISP for Smart Prepaid Metering on DBFOOT basis**

We refer to the RFP dated..... ('RFP') issued by you for selection of Bidder as Advanced Metering Infrastructure Service Provider for establishing the AMI System for ".....[Name of Project]".

We confirm that M/s. .... [Insert name of Sole Bidder/ Consortium Member] has been authorized by us to use our technical and/or financial capability [strikeout whichever is not applicable] for meeting the Qualification Requirements for ".....[Name of Project]".

We have carefully read and examined in detail the RFP including in particular, Clause 7 of Section 2 of the RFP, and we are also submitting legally binding undertaking supported by a board resolution that all the equity investment obligations of M/s..... [Insert Name of Sole Bidder / Consortium Member], shall be deemed to be our equity investment obligations and in the event of any default the same shall be met by us.

For and on behalf of ..... [insert Name of Parent / Affiliated]

.....  
[Signature and Name of the authorized signatory of the Company and stamp]

Name: .....

Date: .....

Place: .....

**Notes:**

1. The above undertaking can be furnished by Ultimate Parent of Technically Evaluated Entity or Financially Evaluated Entity, as the case maybe, if legally binding undertaking is also furnished by the Ultimate Parent on behalf of such Financially Evaluated Entity/Technically Evaluated Entity.

## **Form 18: Format of Undertaking by Technically / Financially Evaluated Entity / Ultimate Parent Company**

[On the Letter Head of the Technically / Financially Evaluated Entity / Ultimate Parent Company]

[Reference No.]

From:

[Address of the Technically / Financially Evaluated Entity / Ultimate Parent Company]

[Telephone No., Fax No., Email]

[Date]

To:

[MVVNL]

[Address]

### **Sub: Bid for Appointment of AMISP for Smart Prepaid Metering on DBFOOT basis**

Dear Sir,

We refer to the Request for Proposal dated ..... ('RFP') issued by you regarding setting up of AMI system for ..... [Name of the Project] on design, build, finance, own, operate and transfer basis.

We have carefully read and examined in detail the RFP and the RFP Project Documents, including in particular, Clause 2 and 4 of Section 7 of the RFP and Clauses 15 of Section 3 of the RFP, regarding submission of an undertaking regarding the investment in the equity share capital of ..... [Name of the SPV] and provisions for minimum equity holding and equity lock-in. We have also noted the amount of the equity investment required to be made in ..... [Name of SPV] by the ..... [insert the name of the Bidder or the Consortium Member] for the Project.

In view of the above, we hereby undertake to you and confirm that in the event of failure of .....[insert the name of the Bidder or the Consortium Member] to invest in full or in part, in the equity share capital of .....[Name of SPV] as specified in the Bid, we shall invest the said amount not invested by ..... [insert the name of the Bidder or the Consortium Member] in ..... [Name of SPV] by purchase of existing shares or subscribing to the new shares of ..... [Name of the SPV], as stipulated by you.

We have attached hereto certified true copy of the Board resolution whereby the Board of Directors of our Company has approved issue of this Undertaking by the Company.

All the terms used herein but not defined, shall have the meaning as ascribed to the said terms under the RFP.

Certified as true.

.....

(Signature and Name of the authorized signatory of the Company and stamp)

Note:

1. Wherever required, extract of the charter documents and documents such as a Board resolution should be submitted for verification.
2. If a Central Public Sector Enterprise (CPSE) / Public Sector Undertaking (PSU) or Subsidiary/ Joint Venture of a CPSE/ PSU is either the sole Bidder or a lead member of a

**Section 4. Technical Proposal –Forms**

---

Bidding Consortium, the bidder shall be exempted from submitting this form (Form 18 of Section 4).

3.

## Form 19: Formats for Board Resolutions

### Format 1

#### **Format of the Board resolution for the Sole Bidder / each Member of the Consortium / investing Affiliate / Parent Company / Ultimate Parent Company, where applicable**

[Reference Clause 15 of Section 3 of the RFP and the illustrations in Annexure of this form]

[**Note:** The following resolution no. 1 needs to be passed by the Boards of each of the entity(ies) making equity investment]

The Board, after discussion, at the duly convened Meeting on ..... [Insert date]. with the consent of all the Directors present and in compliance of the provisions of the Companies Act. 1956/2013, passed the following Resolution:

1. **RESOLVED THAT** pursuant to the provisions of the Companies Act, 1956 / Companies Act 2013 (as the case may be) and compliance thereof and as permitted under the Memorandum and Articles of Association of the company, approval of the Board be and is hereby accorded for investment of .....% (.....per cent) of the total equity share capital.....[Name of SPV] representing the entire amount proposed to be invested by the company for the AMI system for ..... [Name of Project], as per the terms of the RFP.

[Note: Equity investment obligations by the Sole Bidder/each Member of the Bidding Consortium/investing Affiliate or Parent or Ultimate Parent should add up to 100%]

[Note: In the event the Bidder is a Bidding Consortium, the following Board resolution no. 2 also needs to be passed by the Lead Member of the Bidding Consortium]

2. **RESOLVED THAT** approval of the Board be and is hereby accorded to contribute such further amount over and above the ..... percentage (.....%) limit to the extent becoming necessary towards the total equity share in the ..... [Name of SPV]. obligatory on the part of the company pursuant to the terms and conditions contained in the Consortium Agreement dated .....executed by the company as per the provisions of the RFP.

[Note: In the event, the investing entity is an Affiliate or Parent or Ultimate Parent of the Bidder, the following Board resolution no. 3 shall also be passed by the Bidder]

3. **FURTHER RESOLVED THAT** the Board hereby acknowledges the Board Resolution(s) passed by the..... [Name of the Affiliate(s)/ Parent / Ultimate Parent] regarding the investment of.....(....%) of the equity share capital requirements of .....[Name of SPV], which is to be invested by the .....[Name of the Affiliate(s)/ Parent / Ultimate Parent] for the ..... [Name of SPV]. as per the terms of the RFP.

[Note: The following resolution no. 4 is to be provided by the Sole Bidder / Lead Member of the Consortium only]

4. **FURTHER RESOLVED THAT** MR/MS .....be and is hereby authorized to take all the steps required to be taken by the Company for submission of the Bid, including in particular, signing of the Bid, making changes thereto and submitting amended Bid, all the documents related to the Bid, certified copy of this Board resolution or letter or undertakings etc, required to be submitted to **MVVNL** as part of the Bid or such other documents as may be necessary in this regard.

Certified True Copy

Company rubber stamp to be affixed

[Notes:

Section 4. Technical Proposal –Forms

1. This certified true copy should be submitted on the letterhead of the Company, signed by the Company Secretary or any Whole Time Director/ Manager (supported by a specific board resolution) of the Sole Bidder or the Lead Member of Consortium.
2. The contents of the format may be suitably re-worded indicating the identity of the entity passing the resolution, i.e., the Sole Bidder, each Member of the Bidding Consortium.
3. This format may be modified only to the limited extent required to comply with the local regulations and laws applicable to a foreign entity submitting this resolution. For example, reference to Companies Act 1956 / Companies Act 2013 (as the case may be) may be suitably modified to refer to the law applicable to the entity submitting the resolution. However, in such case, the foreign entity shall submit an unqualified opinion issued by the legal counsel of such foreign entity, stating that the Board resolutions are in compliance with the applicable laws of the respective jurisdictions of the issuing company and the authorizations granted therein are true and valid.]
4. If a Central Public Sector Enterprise (CPSE) / Public Sector Undertaking (PSU) or Subsidiary/ Joint Venture of a CPSE/ PSU is either the sole Bidder or a lead member of a Bidding Consortium, the bidder shall be exempted from submitting this form (Form 19 of Section 4).



**Format 2****Format for the Board resolution of Technically / Financially Evaluated Entity / Ultimate Parent Company (in case credentials of such TEE/ FEE has been utilized by the Sole Bidder or Bidding Consortium)**

The Board, after discussion, at the duly convened Meeting on ..... [Insert date] with the consent of all the Directors present and in compliance of the provisions of the Companies Act, 1956/2013. passed the following Resolution:

**RESOLVED THAT** pursuant to the provisions of the Companies Act, 1956 / Companies Act, 2013 (as the case may be) and compliance thereof and as permitted under the Memorandum and Articles of Association of the company, approval of the Board be and is hereby accorded for issuing an Undertaking to the **MVVNL**, in the format specified in the RFP issued by the **MVVNL**, draft of which is attached hereto and initiated by the Chairman whereby the company undertakes to invest ..... percent (.....%) of the total equity share capital of .....[Name Of SPV] representing the entire amount proposed to be invested by ..... [ insert name of the Bidder or Member] for the said Project, in case of failure of ..... [Insert the name of the Bidder or Member] to make such investment".

**FURTHER RESOLVED THAT** ..... be and is hereby authorized to take all the steps required to be taken by the Company, including in particular, signing the said Undertaking, submitting the same to the **MVVNL** through .....[insert name of Sole Bidder / Lead Member of the Consortium] of all the related documents, certified copy of this

Board resolution or letter, undertakings etc. required to be submitted to **MVVNL** as part of the Bid or such other documents as may be necessary in this regard.

**Certified True Copy****Company rubber stamp to be affixed****Note:**

1. This certified true copy should be submitted on the letterhead of the Company, signed by the Company Secretary or any Whole-time Director/Manager (supported by a specific board resolution) of Sole Bidder or Lead Member of the Consortium.
2. The contents of the format may be suitably re-worded indicating the identity Of the entity passing the resolution.
3. This format may be modified only to the limited extent required to comply with the local regulations and laws applicable to a foreign entity submitting this resolution. For example, reference to Companies Act 1956 / Companies Act 2013 (as the case may be) may be suitably modified to refer to the law applicable to the entity submitting the resolution. However, in such case, the foreign entity shall submit an unqualified opinion issued by the legal counsel of such foreign entity, stating that the Board resolutions are in compliance with the applicable laws of the respective jurisdictions of the issuing company and the authorizations granted therein are true and valid.

## **Form 20: Pre-Contract Integrity Pact**

*[To be on non-judicial stamp paper of Rupees One Hundred Only (INR 100/-) or appropriate value as per Stamp Act relevant to place of execution. Foreign companies submitting Bids are required to follow the applicable law in their country.]*

### **General**

This pre-bid pre-contract Agreement (hereinafter called the Integrity Pact) is made on day of the month of 2021, between, on one hand, the ..... (Name of Owner) acting through Shri..... (Name and designation of Project Manager) (hereinafter called the "BUYER", which expression shall mean and include, unless *the* context otherwise requires, his successors in office and assigns) of the First Part and M/s..... (Name of Bidder) represented by Shri\_\_\_\_, Chief Executive Officer (hereinafter called the "BIDDER/Seller" which expression shall mean and include, unless the context otherwise requires, his successors and permitted assigns) of the Second Part.

WHEREAS the BUYER proposes to procure (Name of the Stores/Equipment/Item) and the BIDDER/Seller is willing to offer/has offered the stores and

WHEREAS the BIDDER is a private company/public company/Government undertaking/partnership/registered export agency, constituted in accordance with the relevant law in the matter and the BUYER is a PSU/Utility/Department of State Govt. performing its functions on behalf of the ..... (Name of owner).

NOW, THEREFORE,

To avoid all forms of corruption by following a system that is fair, transparent and free from any influence/prejudiced dealings prior to, during and subsequent to the currency of the contract to be entered into with a view to:-

Enabling the BUYER to obtain the desired said stores/equipment at a competitive price in conformity with the defined specifications by avoiding the high cost and the distortionary impact of corruption on public procurement, and

Enabling BIDDERS to abstain from bribing or indulging in any corrupt practice in order to secure the contract by providing assurance to them that their competitors will also abstain from bribing and other corrupt practices and the BUYER will commit to prevent corruption, in any form, by its officials by following transparent procedures.

The parties hereto hereby agree to enter into this Integrity Pact and agree as follows:

### **Commitments of the BUYER**

- 1.1 The BUYER undertakes that no official of the BUYER, connected directly or indirectly with the contract, will demand, take a promise for or accept, directly or through intermediaries, any bribe, consideration, gift, reward, favour or any material or immaterial

Section 4. Technical Proposal –Forms

benefit or any other advantage from the BIDDER, either for themselves or for any person, organisation or third party related to the contract in exchange for an advantage in the bidding process, bid evaluation, contracting or implementation process related to the contract.

1.2 The BUYER will, during the pre-contract stage, treat all BIDDERS alike and will provide to all BIDDERS the same information and will not provide any such information to any particular BIDDER which could afford an advantage to that particular BIDDER in comparison to other BIDDERS.

1.3 All the officials of the BUYER will report to the appropriate Government office any attempted or completed breaches of the above commitments as well as any substantial suspicion of such a breach

2.0 In case any such preceding misconduct on the part of such official(s) is reported by the BIDDER to the BUYER with full and verifiable facts and the same is prima facie found to be correct by the BUYER, necessary disciplinary proceedings, or any other action as deemed fit, including criminal proceedings may be initiated by the BUYER and such a person shall be debarred from further dealings related to the contract process. In such a case while an enquiry is being conducted by the BUYER the proceedings under the contract would not be stalled.

**Commitments of BIDDERS**

3.0 The BIDDER commits itself to take all measures necessary to prevent corrupt practices, unfair means and illegal activities during any stage of its bid or during any pre-contract or post-contract stage in order to secure the contract or in furtherance to secure it and in particular commit itself to the following:-

3.1 The BIDDER will not offer, directly or through intermediaries, any bribe, gift, consideration, reward, favour, any material or immaterial benefit or other advantage, commission, fees, brokerage or inducement to any official of the BUYER, connected directly or indirectly with the bidding process, or to any person, organization or third party related to the contract in exchange for any advantage in the bidding, evaluation, contracting and implementation of the contract.

3.2 The BIDDER further undertakes that it has not given, offered or promised to give, directly or indirectly any bribe, gift, consideration, reward, favour, any material or immaterial benefit or other advantage, commission, fees, brokerage or inducement to any official of the BUYER or otherwise in procuring the Contract or forbearing to do or having done any act in relation to the obtaining or execution of the contract or any other contract with the Government for showing or for bearing to show favour or disfavor to any person in relation to the contract or any other contract with Government.

3.3 BIDDERS shall disclose the name and address of agents and representatives and Indian BIDDERS shall disclose their foreign principals or associates.

3.4 BIDDERS shall disclose the payments to be made by them to agents/brokers or any other intermediary, in connection with this bid/contract.

- 3.5 The BIDDER further confirms and declares to the BUYER that the BIDDER is the original manufacturer/integrator/authorized government sponsored export entity of the defense stores and has not engaged any individual or firm or company whether Indian or foreign to intercede, facilitate or in any way to recommend to the BUYER or any of its functionaries, whether officially 'or unofficially to the award of the contract to the BIDDER, nor has any amount been paid, promised or intended to be paid to any such individual, firm or company in respect of any such intercession, facilitation or recommendation.
- 3.6 The BIDDER, either while presenting the bid or during pre-contract negotiations or before signing the contract, shall disclose any payments he has made, is committed to or intends to make to officials of the BUYER or their family members, agents, brokers or any other intermediaries in connection with the contract and the details of services agreed upon for such payments.
- 3.7 The BIDDER will not collude with other parties interested in the contract to impair the transparency, fairness and progress of the bidding process, bid evaluation, contracting and implementation of the contract.
- 3.8 The BIDDER will not accept any advantage in exchange for any corrupt practice, unfair means and illegal activities.
- 3.9 The BIDDER shall not use improperly, for purposes of competition or personal gain, or pass on to others, any information provided by the BUYER as part of the business relationship, regarding plans, technical proposals and business details, including information contained in any electronic data carrier. The BIDDER also undertakes to exercise due and adequate care lest any such information is divulged.
- 3.10 The BIDDER commits to refrain from giving any complaint directly or through any other manner without supporting it with full and verifiable facts.
- 3.11 The BIDDER shall not instigate or cause to instigate any third person to commit any of the actions mentioned above.
- 3.12 If the BIDDER or any employee of the BIDDER or any person acting on behalf of the BIDDER, either directly or indirectly, is a relative of any of the officers of the BUYER, or alternatively, if any relative of an officer of the BUYER has financial interest/stake in the BIDDER's firm, the same shall be disclosed by the BIDDER at the time of filing of tender.

The term 'relative' for this purpose would be as defined in Section 6 of the Companies Act 1956.

- 3.13 The BIDDER shall not lend to or borrow any money from or enter into any monetary dealings or transactions, directly or indirectly, with any employee of the BUYER.

#### **4. Previous Transgression**

- 4.1 The BIDDER declares that no previous transgression occurred in the last three years

#### Section 4. Technical Proposal –Forms

immediately before signing of this Integrity Pact, with any other company in any country in respect of any corrupt practices envisaged hereunder or with any Public Sector Enterprise in India or any Government Department in India that could justify BIDDER's exclusion from the tender process.

- 4.2 The BIDDER agrees that if it makes incorrect statement on this subject, BIDDER can be disqualified from the tender process or the contract, if already awarded, can be terminated for such reason.

#### **5. Earnest Money (Security Deposit)**

- 5.1 While submitting commercial bid, the BIDDER shall deposit an amount..... (to be specified in RFP) as Earnest Money/Security Deposit, with the BUYER through any of the following instruments:

- (i) Bank Draft or a Pay Order in favour of
- (ii) A confirmed guarantee by an Indian Nationalised Bank, promising payment of the guaranteed sum to the BUYER on demand within three working days without any demur whatsoever and without seeking any reasons whatsoever. The demand for payment by the BUYER shall be treated as conclusive proof of payment.
- (iii) Any other mode or through any other instrument (to be specified in the RFP).

- 5.2 The Earnest Money/Security Deposit shall be valid upto a period of ..... years or the complete conclusion of the contractual obligations to the complete satisfaction of both the BIDDER and the BUYER, including warranty period, whichever is later.

- 5.3 In case of the successful BIDDER a clause would also be incorporated in the Article pertaining to Performance Bond in the Purchase Contract that the provisions of Sanctions for Violation shall be applicable for forfeiture of Performance Bond in case of a decision by the BUYER to forfeit the same without assigning any reason for imposing sanction for violation of this Pact.

- 5.4 No interest shall be payable by the BUYER to the BIDDER on Earnest Money/Security Deposit for the period of its currency.

#### **6. Sanctions for Violations**

- 6.1 Any breach of the aforesaid provisions by the BIDDER or anyone employed by it or acting on its behalf (whether with or without the knowledge of the BIDDER) shall entitle the BUYER to take all or any one of the following actions wherever required:

- (i) To immediately call off the pre-contract negotiations without assigning any reason or giving any compensation to the BIDDER. However, the proceedings with the other BIDDER(s) would continue.
- (ii) The Earnest Money Deposit (in pre-contract stage) and/or Security Deposit/Performance Bond (after the contract is signed) shall stand forfeited either fully or partially, as decided by the BUYER and the BUYER shall not be required to assign any reason,

therefore.

- (iii) To immediately cancel the contract, if already signed, without giving any compensation to the BIDDER.
- (iv) To recover all sums already paid by the BUYER, and in case of an Indian BIDDER with interest thereon at 2% higher than the prevailing Prime Lending Rate of State Bank of India, while in case of a BIDDER from a country other than India with interest thereon at 2% higher than the UBOR. If any outstanding payment is due to the BIDDER from the BUYER in connection with any other contract for any other stores, such outstanding payment could also be utilized to recover the aforesaid sum and interest.
- (v) To encash the advance bank guarantee and performance bond/warranty bond, if furnished by the BIDDER, in order to recover the payments, already made by the BUYER, along with interest.
- (vi) To cancel all or any other Contracts with the BIDDER. The BIDDER shall be liable to pay compensation for any loss 'or damage to the BUYER resulting from such cancellation/rescission and the BUYER shall be entitled to deduct the amount so payable from the money(s) due to the BIDDER
- (vii) To debar the BIDDER from participating in future bidding processes of the Government of India for a minimum period of five years, which may be further extended at the discretion of the BUYER.
- (viii) To recover all sums paid in violation of this Pact by BIDDER(s) to any middleman or agent or broker with a view to securing the contract.
- (ix) In cases where irrevocable Letters of Credit have been received in respect of any contract signed by the BUYER with the BIDDER, the same shall not be opened.
- (x) Forfeiture of Performance Bond in case of a decision by the BUYER to forfeit the same without assigning any reason for imposing sanction for violation of this Pact.

6.2 The BUYER will be entitled to take all or any of the actions mentioned at para 6.1(i) to (x) of this Pact also on the Commission by the BIDDER or anyone employed by it or acting on its behalf (whether with or without the knowledge of the BIDDER), of an offence as defined in Chapter IX of the Indian Penal code, 1860 or Prevention of Corruption Act, 1988 or any other statute enacted for prevention of corruption.

6.3 The decision of the BUYER to the effect that a breach of the provisions of this Pact has been committed by the BIDDER shall be final and conclusive on the BIDDER. However, the BIDDER can approach the Independent Monitor(s) appointed for the purposes of this Pact.

## 7. Deleted

## 8. Independent Monitors

#### Section 4. Technical Proposal –Forms

- 8.1 The BUYER has appointed Independent Monitors (hereinafter referred to as Monitors) for this Pact in consultation with the Central Vigilance to as Monitors) for this Pact in consultation with the Central Vigilance Commission (Names and Addresses of the Monitors to be given).
- 8.2 The task of the Monitors shall be to review independently and objectively, whether and to what extent the parties comply with the obligations under this Pact.
- 8.3 The Monitors shall not be subject to instructions by the representatives of the parties and perform their functions neutrally and independently.
- 8.4 Both the parties accept that the Monitors have the right to access all the documents relating to the project/procurement, including minutes of meetings.
- 8.5 As soon as the Monitor notices, or has reason to believe, a violation of this Pact, he will so inform the Authority designated by the BUYER.
- 8.6 The BIDDER(s) accepts that the Monitor has the right to access without restriction to all Project documentation of the BUYER including that provided by the BIDDER. The BIDDER will also grant the Monitor, upon his request and demonstration of a valid interest, unrestricted and unconditional access to his project documentation. The same is applicable to Subcontractors. The Monitor shall be under contractual obligation to treat the information and documents of the BIDDER/Subcontractor(s) with confidentiality.
- 8.7 The BUYER will provide to the Monitor sufficient information about all meetings among the parties related to the Project provided such meetings could have an impact on the contractual relations between the parties. The parties will offer to the Monitor the option to participate in such meetings.
- 8.8 The Monitor will submit a written report to the designated Authority of BUYER/Secretary in the Department/ within 8 to 10 weeks from the date of reference or intimation to him by the BUYER / BIDDER and, should the occasion arise, submit proposals for correcting problematic situations.

#### **9. Facilitation of Investigation**

In case of any allegation of violation of any provisions of this Pact or payment of commission, the BUYER or its agencies shall be entitled to examine all the documents including the Books of Accounts of the BIDDER and the BIDDER shall provide necessary information and documents in English and shall extend all possible help for the purpose of such examination.

#### **10. Law and Place of Jurisdiction**

This Pact is subject to Indian Law. The place of performance and jurisdiction is the seat of the BUYER.

#### **11. Other Legal Actions**

The actions stipulated in this Integrity Pact are without prejudice to any other legal action that may follow in accordance with the provisions of the extant law in force relating to any civil or criminal

**12. Validity**

12.1 The validity of this Integrity Pact shall be from date of its signing and extend upto 5 years or the complete execution of the contract to the satisfaction of both the BUYER and the BIDDER/Seller, including warranty period, whichever is later. In case BIDDER is unsuccessful, this Integrity Pact shall expire after six months from the date of the signing of the contract.

12.2 Should one or several provisions of this Pact turn out to be invalid; the remainder of this Pact shall remain valid. In this case, the parties will strive to come to an agreement to their original intentions.

13. The parties hereby sign this Integrity Pact at .....on.....

BUYER  
Name of the Officer  
Designation

BIDDER  
XXXX

Witness  
1.....  
2.....

Witness  
2.....  
3.....

\* Provisions of these clauses would need to be amended/ deleted in line with the policy of the BUYER in regard to involvement of Indian agents of foreign suppliers



**Form 21: Data Requirement Sheet**

*Please Note: In case of any deviation of minimum requirement of features (listed below) from the existing BIS standards, the existing BIS standards shall prevail over the same>*

**Single Phase Whole Current Smart Prepaid Meter**

S. No.	Description of the Features	Minimum Requirement of Features	As per Bidder Offering
1	Applicable Standards	The meters shall comply with IS 16444 Part 1 for all requirements.	
2	Reference Voltage	As per relevant IS (240 V)	
3	Current Rating	10-60 A	
4	Category	UC1	
5	Starting Current	As per IS 16444 Part 1	
6	Accuracy	Class 1.0 as per IS 16444 Part 1	
7	Limits of error	As per IS 16444 Part 1	
8	Operating Temperature range	As per IS 13779	
9	Humidity	As per IS 13779	
10	Frequency	As per IS 16444 Part 1	
11	Influence Quantities	As per IS 16444 Part 1	
12	Power Consumption of meter	As per IS 16444 Part 1	
13	Current and Voltage Circuit	As per IS 16444 Part 1	
14	Running at No Load	As per IS 16444 Part 1	
15	Test output device	As per IS 16444 Part 1	
16	Meter Display	As per IS 16444 Part 1	
17	Name Plate & marking Meter Display	As per IS 16444 Part 1	
18	Parameters to be measured	As per IS 16444 Part 1 / As per IS 15959 Part-2	
19	Maximum Demand resetting	As per IS 15959 Part 2	
20	Time of Use registers	As per IS 15959 part 2	
21	Power Quality Information	As per IS 15959 part 2	
22	LED/LCD Indicators	As per IS 16444 Part 1	
23	Load Survey/Interval Data	As per IS 15959 part 2	
24	Tamper/ Event Recording	As per IS 15959 part 2	
25	Measuring Elements	As per IS 16444 part 1	
26	Alarm	As per IS 16444 Part 1/ 15959 Part 2	
27	Load Control	As per IS 16444 Part 1	
28	Connect/Disconnect	UC1 (As per IS 16444 part 1)	

## Section 4. Technical Proposal –Forms

S. No.	Description of the Features	Minimum Requirement of Features	As per Bidder Offering
	switch		
29	Status of load switch	As per IS 16444 Part 1	
30	Programmability	As per IS 16444 Part 1	
31	Communication	As per IS 16444. Part 1	
32	Data Exchange Protocol	As per IS 16444 Part 1	
33	Remote Firmware upgrade	As per IS 15959 part 2	
34	Real Time Clock (RTC)	As per IS 16444 Part 1 IS 15959 Part1 & Part 2	
35	Data Retention	As per IS 16444 Part 1	
36	Battery Backup	Meter shall be supplied with adequate separate battery backup for RTC.	
37	First Breath (power on) and Last gasp (power off) condition detection and communication to HES	As per IS 16444 Part 1	
38	Plug-in Communication Module	The Smart Meters shall be have a dedicated sealable slot for accommodating plug-in type bi -directional communication module which shall integrate the respective communication technology ( RF/Cellular) with the Smart Meters, leading to easy adaptability for network interfaces (WAN/NAN).The Plug-In module shall be field swappable/ replaceable.	
39	Anti-Tamper Features	The meter shall continue working under tamper conditions as defined in IS 15959 Part 2 and would log the event and send alarm at Head End System after detection of the defined tamper features as per IS 15959 Part 2	
40	Data Display Facility	As per IS 16444. However, minimum requirements should include the following: Data Display shall be in two modes- 1. Auto Scroll 2. Scroll with Push Button The display parameters shall be:	

## Section 4. Technical Proposal –Forms

S. No.	Description of the Features	Minimum Requirement of Features	As per Bidder Offering
		<p>Auto Scroll Mode:</p> <ul style="list-style-type: none"> <li>• Display Check</li> <li>• Date and Time</li> <li>• Last Recharge Amount</li> <li>• Last Recharge Time</li> <li>• Current Balance Amount</li> <li>• Current Balance Time</li> <li>• Cumulative Active Energy kWh with legend.</li> <li>• Current calendar month MD in kW with legend.</li> <li>• Instantaneous voltage</li> <li>• Instantaneous Phase current</li> <li>• Instantaneous Load kW</li> <li>• Instantaneous average Power Factor</li> </ul> <p>These parameters should be displayed on the Meter Display continuously for a period of 10 seconds on Auto scroll.</p> <p>Scroll with Push-button:</p> <ul style="list-style-type: none"> <li>• All Parameters mentioned under Auto-Scroll mode should be displayed. Additionally, the following Parameters shall also be displayed:</li> <li>• Internal diagnostics (display check)</li> <li>• Meter Serial No.</li> <li>• Last month cumulative kWh with legends</li> <li>• Last month MD in kW with legends</li> <li>• Current month Average Power Factor</li> <li>• Last month Average Power Factor</li> <li>• 2<sup>nd</sup> Last month cumulative kWh with legends</li> <li>• 2<sup>nd</sup> Last month MD in kW with data and time of Occurrence</li> <li>• 3<sup>rd</sup> Last month cumulative kWh with legends</li> <li>• 3<sup>rd</sup> Last month MD in kW with data and time of Occurrence</li> </ul>	

## Section 4. Technical Proposal –Forms

S. No.	Description of the Features	Minimum Requirement of Features	As per Bidder Offering
		<p>Further, the Meter should display high resolution energy values with resolution of 3 digits before decimal and 2 digits after decimal in push button mode</p> <p>The meter's display should return to default display mode (continues auto scroll) if push button is not operated for more than 10 seconds. (The order of display may be revised as per requirement of the <b>MVVNL</b>). Meter display should not go in to sleep mode during Power-On condition in case the push button is not operated for more than 10 minutes</p>	

**Three Phase Whole Current Smart Pre-paid Meter**

S. No.	Description of the Features	Minimum Requirement of Features	As per Bidder Offering
1	Applicable Standards	The meters shall comply with IS 16444 Part 1 for all requirements.	
2	Reference Voltage	As per relevant IS	
3	Current Rating	20-100 A	
4	Category	UC1	
5	Starting Current	As per IS 16444 Part 1	
6	Accuracy	Class 1.0 as per IS 16444 Part 1	
7	Limits of error	As per IS 16444 Part 1	
8	Operating Temperature range	As per IS 13779	
9	Humidity	As per IS 13779	
10	Frequency	As per IS 16444 Part 1	
11	Influence Quantities	As per IS 16444 Part 1	
12	Power Consumption of meter	As per IS 16444 Part 1	
13	Current and Voltage Circuit	As per IS 16444 Part 1	
14	Running at No Load	As per IS 16444 Part 1	
15	Test output device	As per IS 16444 Part 1	
16	Meter Display	As per IS 16444 Part 1	
17	Name Plate & marking Meter Display	As per IS 16444 Part 1	
18	Parameters to be measured	As per IS 16444 Part 1 / As per IS 15959 Part-2	
19	Maximum Demand resetting	As per IS 15959 Part-2	
20	Time of Use registers	As per IS 15959 Part-2	
21	Power Quality Information	As per IS 15959 Part-2	
22	LED/LCD Indicators	As per IS 16444 Part 1	
23	Load Survey/Interval Data	As per IS 15959 Part-2	
24	Tamper/ Event Recording	As per IS 15959 Part-2	
25	Measuring Elements	As per Is 16444 Part 1	
26	Alarm	As per IS 16444 Part 1 / As per IS 15959 Part-2	
27	Load Control	As per IS 16444 Part 1	
28	Connect/Disconnect switch	UC1 as per IS 16444 Part 1	

## Section 4. Technical Proposal –Forms

S. No.	Description of the Features	Minimum Requirement of Features	As per Bidder Offering
29	Status of Load switch	As per IS 16444 Part 1	
30	Programmability	As per IS 16444 Part 1	
31	Communication	As per IS 16444 Part 1	
32	Communication Protocol	As per IS 16444 Part 1	
33	Remote Firmware upgrade	As per IS 15959 Part-2	
34	Real Time Clock (RTC)	As per IS 16444 Part 1 / IS 15959 Part 1 & Part 2	
35	Data Retention	As per 16444 Part 2	
36	Battery Backup	Meter shall be supplied with adequate separate battery backup for RTC.	
37	First Breath (Power on) and Last gasp (Power off) condition detection and communication to HES	As per IS 16444 Part 1	
38	Plug-in Communication Module	The Smart Meters shall be have a dedicated sealable slot for accommodating plug-in type bi - directional communication module which shall integrate the respective communication technology ( RF/ Cellular) with the Smart Meters, leading to easy adaptability for network interfaces (WAN/NAN).The Plug-In module shall be field swappable/ replaceable.	
39	Anti-Tamper Features	The meter shall continue working under tamper conditions as defined in IS 15959 Part 2 and would log the event and send alarm at Head End System after detection of the defined tamper features as per IS 15959 Part 2	
39	Data Display Facility	As per IS 16444. However, minimum requirements should include the following: Data Display shall be in two modes- <ul style="list-style-type: none"> <li>• Auto Scroll</li> <li>• Scroll with Push Button</li> </ul> The display parameters shall be: <ul style="list-style-type: none"> <li>• Auto Scroll</li> <li>• Display Check</li> <li>• Date and Time</li> </ul>	

## Section 4. Technical Proposal –Forms

S. No.	Description of the Features	Minimum Requirement of Features	As per Bidder Offering
		<ul style="list-style-type: none"> <li>• Last Recharge Amount</li> <li>• Last Recharge Time</li> <li>• Current Balance Amount</li> <li>• Current Balance Time</li> <li>• Cumulative Active Energy kWh with legend.</li> <li>• Cumulative Active Energy kVAh with legend.</li> <li>• Current month MD in kW with legend.</li> <li>• Current month average Power Factor</li> <li>• Instantaneous voltage VRN</li> <li>• Instantaneous voltage VYN</li> <li>• Instantaneous voltage VBN</li> <li>• Instantaneous current IR</li> <li>• Instantaneous current IY</li> <li>• Instantaneous current IB</li> <li>• Instantaneous current IN</li> <li>• Instantaneous Load kW and kVA</li> <li>• Instantaneous average Power Factor</li> </ul> <p>These parameters should be displayed on the LCD/LED continuously for a period of 10 seconds on Auto scroll.</p> <ul style="list-style-type: none"> <li>• Scroll with Push-button</li> </ul> <p>All Parameters mentioned under Auto-Scroll mode should be displayed. Additionally, the following Parameters shall also be displayed:</p> <ul style="list-style-type: none"> <li>• Internal diagnostics (display check)</li> <li>• Meter Serial No</li> <li>• Cumulative Energy in kVArh Lag/Lead with legend</li> <li>• Cumulative Active Energy kWh ToD wise with legends.</li> <li>• Cumulative Apparent Energy kVAh ToD wise with legends.</li> <li>• Current month MD in kVAh with legends</li> <li>• Last month cumulative kWh with</li> </ul>	

## Section 4. Technical Proposal –Forms

S. No.	Description of the Features	Minimum Requirement of Features	As per Bidder Offering
		<p>legends</p> <ul style="list-style-type: none"> <li>• Last month cumulative kVAh with legends</li> <li>• Last month MD in kW with legends</li> <li>• Last month Average Power Factor</li> <li>• 2<sup>nd</sup> Last month cumulative kWh with legends</li> <li>• 2<sup>nd</sup> Last month cumulative kVAh with legends</li> <li>• 2<sup>nd</sup> Last month MD in kW with data and time of Occurrence</li> <li>• 3<sup>rd</sup> Last month cumulative kWh with legends</li> <li>• 3<sup>rd</sup> Last month cumulative kVAh with legends</li> <li>• 3<sup>rd</sup> Last month MD in kW with data and time of Occurrence</li> </ul> <p>Further, the Meter should display High Resolution energy values with resolution of 3 digits before decimal and 2 digits after decimal in push button mode.</p> <p>The meter's display should return to default display mode (continues auto scroll) if push button is not operated for more than 10 seconds. (The order of display may be as per the requirement of the <b>MVVNL</b>). Meter display should not go in to sleep mode during Power-On condition in case the push button is not operated for more than 10 minutes</p>	

**Three Phase LT-CT Operated Smart Meter**

S. No.	Description of the Features	Minimum Requirement of Features	As per Bidder Offering
1	Applicable Standards	The meters shall comply with IS 16444: Part2 for all requirements except for those parameters which have been specifically mentioned to be otherwise in this specification.	
2	Reference Voltage	[As per relevant IS]	
3	Current Rating	1b 5A	
4	Starting Current	As per IS 16444: Part2	



## Section 4. Technical Proposal –Forms

S. No.	Description of the Features	Minimum Requirement of Features	As per Bidder Offering
5	Accuracy	Class 0.5S as per IS 16444: Part2	
6	Limits of error	As per IS 16444: Part2	
7	Operating Temperature range	As per IS 16444: Part2	
8	Humidity	As per IS 16444: Part2	
9	Frequency	As per IS 16444: Part2	
10	Influence Quantities	As per IS 16444: Part2	
11	Power Consumption of meter excluding communication module	As per I S 16444: Part2	
12	Current and Voltage circuit	As per IS 16444: Part2	
13	Running at No Load	As per IS 16444: Part2	
14	Test output device	As per IS 16444: Part2	
15	Meter Display	As per IS 16444: Part 2	
16	Time of Use (In case of net-meter both export & import parameters to be measured)	As per IS 15959: Part 3 (as applicable)	
17	Parameters to be measured	As per IS 16444: Part 2 / As per IS 15959: Part 3 (as applicable)	
18	Power Quality Information	As per IS 15959: Part 3 (as applicable)	
19	Maximum Demand	As per IS 15959: Part 3 (as applicable)	
20	Load Survey/Interval Data	As per IS 15959: Part 3 (as applicable)	
21	LED/LCD Indicators	As per IS 16444: Part 2	
22	Tamper/Event recording	As per IS 15959: Part 3 (as applicable)	
23	Alarm	As per IS 16444: Part 2 / IS 15959: Part 3 (as applicable)	
24	Measuring Elements	As per IS 16444: Part 2	
25	Anti-Tamper features	The meter shall continue working under tamper conditions as defined in IS 15959 : Part 3 (as applicable)and would log the event and send alarm at HES after logging of the defined tamper features as per IS 15959 : Part 3 (as applicable)	
26	Programmability	As per IS 16444 Part 2.	

## Section 4. Technical Proposal –Forms

S. No.	Description of the Features	Minimum Requirement of Features	As per Bidder Offering
27	Communication	As per IS 16444 Part 2	
28	Communication Protocol	As per IS 15959: Part 3 (as applicable)	
29	Real Time Clock (RTC)	As per IS 16444: Part 2 / IS 15959: Part 3 (as applicable)	
30	Data Retention	As per IS 16444 Part 2	
31	Battery Backup	Meter shall be supplied with separate battery backup for RTC	
32	Data display facility (manual/Auto)	<p>As per IS 16444: Part 2.</p> <p>Data Display shall have following features:</p> <ul style="list-style-type: none"> <li>• High Resolution (Shall display energy values with resolution of 2 digits before decimal and 5 digits after decimal.</li> <li>• The Push button for manual scrolling in addition to auto scrolling with a persistence time of 10 seconds for each parameter shall be provided.</li> </ul> <p>Display of data as per IS 16444 (Part 2)</p>	
33	Remote Firmware Upgrade	As per IS 15959 : Part 3 (as applicable)	
34	Digital Input (For DTs)	<p>The Smart meter should have the provision of sensing digital inputs via DI (Digital Input) port provided at the terminal block. The smart meter should register the digital input(s) sensed, upon reaching respective threshold (configurable) and the event shall be communicated to HES. The OBIS code required for this shall be provided during detailed engineering.</p> <p>The requisite power supply requirement (AC to DC auxiliary supply/ charger) for the DI should be made internal to the smart meter itself. In case the same is not feasible to be provided, bidder should provide external power supply with following specifications.</p> <ol style="list-style-type: none"> <li>Input voltage: 63.5V AC</li> <li>Operating voltage: 12V DC</li> <li>Contact Rating: 5A Continuous @30V DC, 25A for 3 sec</li> </ol>	

## Section 4. Technical Proposal –Forms

S. No.	Description of the Features	Minimum Requirement of Features	As per Bidder Offering
		No. of DIs are as follows: 04 Nos. DI for 4V(DC), 10 mA	

**Three Phase CT/PT Operated Smart Meter**

S. No.	Description of the Features	Minimum Requirement of Features	As per Bidder Offering
1	Applicable Standards	The meters shall comply with IS 16444: Part2 for all requirements except for those parameters which have been specifically mentioned to be otherwise in this specification.	
2	Reference Voltage	[As per relevant IS]	
3	Current Rating	lb 5A/ 1A	
4	Starting Current	As per IS 16444: Part2	
5	Accuracy	Class 0.5S or 0.2S as per IS 16444: Part2	
6	Limits of error	As per IS 16444: Part2	
7	Operating Temperature range	As per IS 16444: Part2	
8	Humidity	As per IS 16444: Part2	
9	Frequency	As per IS 16444: Part2	
10	Influence Quantities	As per IS 16444: Part2	
11	Power Consumption of meter excluding communication module	As per I S 16444: Part2	
12	Current and Voltage circuit	As per IS 16444: Part2	
13	Running at No Load	As per IS 16444: Part2	
14	Test output device	As per IS 16444: Part2	
15	Meter Display	As per IS 16444: Part 2	
16	Time of Use (In case of net-meter both export & import parameters to be measured)	As per IS 15959 Part 3 (as applicable)	
17	Parameters to be measured	As per IS 16444: Part 2 / As per IS 15959: Part 3 (as applicable)	
18	Power Quality Information	As per IS 15959 Part 3 (as applicable)	
19	Maximum Demand	As per IS 15959: Part 3 (as applicable)	
20	Load Survey/Interval Data	As per IS 15959: Part 3 (as applicable)	

## Section 4. Technical Proposal –Forms

S. No.	Description of the Features	Minimum Requirement of Features	As per Bidder Offering
21	LED/LCD Indicators	As per IS 16444 Part 2	
22	Tamper/Event recording	As per IS 15959: Part 3 (as applicable)	
23	Alarm	As per IS 16444: Part 2 / IS 15959: Part 3 (as applicable)	
24	Measuring Elements	As per IS 16444: Part 2	
25	Anti-Tamper features	The meter shall continue working under tamper conditions as defined in IS 15959 : Part 3 (as applicable) and would log the event and send alarm at HES after logging of the defined tamper features as per IS 15959 : Part 3 (as applicable)	
26	Programmability	As per IS 16444 Part 2.	
27	Communication	As per IS 16444 Part 2	
28	Communication Protocol	As per IS 15959: Part 3 (as applicable)	
29	Real Time Clock (RTC)	As per IS 16444: Part 2 / IS 15959: Part 3 (as applicable)	
30	Data Retention	As per IS 16444 Part 2	
31	Battery Backup	Meter shall be supplied with separate battery backup for RTC	
32	Data display facility (manual/Auto)	As per IS 16444: Part 2. Data Display shall have following features: <ul style="list-style-type: none"> <li>High Resolution (Shall display energy values with resolution of 2 digits before decimal and 5 digits after decimal.</li> <li>The Push button for manual scrolling in addition to auto scrolling with a persistence time of 10 seconds for each parameter shall be provided.</li> </ul> Display of data as per IS 16444 (Part 2)	
33	Remote Firmware Upgrade	As per IS 15959: Part 3 (as applicable)	

**Routers for RF Mesh Network (If Applicable)**

S. No.	Description of the Features	Minimum Requirement of Features	As per Bidder Offering
1.	<b>General Requirements</b>	<ul style="list-style-type: none"> <li>• The communication network shall have dynamic &amp; self-healing capability. If one of the communication elements such as router or access point fails, then nodes connecting to that element shall switch to best available element for communication of data to HES.</li> <li>• It shall support IPv6 network addressing.</li> <li>• Each node shall keep a track of best available nearby nodes.</li> <li>• The communication network equipment shall use Unlicensed or Licensed frequency band as permitted by WPC/Statutory Bodies in India.</li> <li>• Suitable network management system (NMS) shall be available to monitor the performance of the communication network round the clock. The NMS shall provide viewing of all the networking elements deployed at site and enable configuration, parameterization of the networking devices and the nodes.</li> <li>• It shall support remote firmware upgrading as per IS 16444</li> <li>• It shall be secure enough to avoid all cyber threats such as DDoS, spoofing, malwares etc.</li> <li>• The communication network shall ensure secure communication of data to HES.</li> <li>• The equipment shall be weatherproof, dustproof and constructed for outdoor installation on poles (minimum rating: IP-65). A suitable mounting provision shall be made for the equipment.</li> <li>• Enclosure: Provision for security sealing shall be provided and in case the gasket of the cover is used for protection against moisture, dust and insects, the gasket shall be made of weather and aging resistant material.</li> <li>• The list of standards followed in all the devices/equipment used in communication network shall be furnished.</li> <li>•</li> </ul>	

**Access Points for Communication Networks (if Applicable)**

S. No.	Description of the Features	Minimum Requirement of Features	As per Bidder Offering
1.	<b>Configuration Requirement</b>	<ul style="list-style-type: none"> <li>• It shall be able to configure the communication with underlying nodes/end points.</li> <li>• It shall support on demand read and ping of individual/group of meters.</li> <li>• It shall push events such as tamper, power off etc. to HES immediately on occurrence/receipt from field devices/meters.</li> <li>• It shall have Wide Area Network (WAN) connectivity to the HES through suitable means.</li> <li>• It shall communicate with routers/nodes/end points on RF / RF mesh (Unlicensed or Licensed frequency band as permitted by WPC/Statutory Bodies in country of deployment as applicable).</li> <li>• It shall periodically monitor meter reads/downstream commands and shall retry and reconnect in case of failed events/reads.</li> <li>• After power Interruption, on restoration of power supply, it shall establish communication with underlying devices as well as upstream application (HES) automatically.</li> <li>• Access point shall facilitate recording of: <ul style="list-style-type: none"> <li>○ No of packet failures</li> <li>○ Retry attempts</li> <li>○ Missed periodic reading</li> <li>○ Failure to connect</li> <li>○ Tamper events</li> </ul> </li> <li>• It shall be capable to handle interval data of suitable nos. of any type of Smart Meter (1ph/3ph). Access point shall be able to acquire and send data to HES for full capacity (No. of meters/field devices it is designed for) within a suitable time period to achieve the performance level. Full capacity of access point is required to be indicated in the offer.</li> <li>• Access point shall support remote firmware</li> </ul>	

## Section 4. Technical Proposal –Forms

S. No.	Description of the Features	Minimum Requirement of Features	As per Bidder Offering
		upgrades as well as remote configuration from the Network Operation cum Monitoring Center.	

**Data Concentrator Unit (DCU) (If Applicable)**

S. No.	Description of the Features	Minimum Requirement of Features	As per Bidder Offering
1.	<b>Configuration, Functionality &amp; Interface</b>	<ul style="list-style-type: none"> <li>It shall be able to configure the communication with underlying nodes/meters.</li> <li>It shall pull data from the field devices and push the data at configured intervals to the HES. It should also support the HES in pulling data from the field devices/meters. The data acquisition (Push/Pull) frequency shall be programmable. DCU shall be capable to prioritize control commands.</li> <li>DCU shall ensure a secure communication to HES and shall have internal memory for storing interval data for at least 5 (five) days.</li> <li>DCU shall support on demand read and ping of individual/group of meters.</li> <li>It shall support IPv6 network addressing.</li> <li>DCU shall push events such as tamper, power off etc. to HES immediately on occurrence/receipt from field devices/meters.</li> <li>The equipment shall be weatherproof, dustproof and constructed for outdoor installation on poles (minimum rating: IP-65). A suitable mounting provision shall be made for the equipment.</li> <li>Enclosure: Provision for security sealing shall be provided and in case the gasket of the cover is used for protection against moisture, dust and insects, the gasket shall be made of weather and aging resistant material.</li> </ul>	
2.	<b>Communication</b>	<ul style="list-style-type: none"> <li>The communication architecture shall be any, as defined under IS 16444.</li> <li>The DCU shall ensure the appropriate backhaul for secure transfer of data to HES either via cellular or Fiber Optic communication. In case of cellular</li> </ul>	

## Section 4. Technical Proposal –Forms

S. No.	Description of the Features	Minimum Requirement of Features	As per Bidder Offering
		<p>backhaul, it shall support dual SIM card with dynamic IP from any Implementing Agency. It shall have Wide Area Network (WAN) connectivity to the HES through suitable means.</p> <ul style="list-style-type: none"> <li>• DCU shall be able to communicate with meters either on RF / RF mesh (Unlicensed or Licensed frequency band as permitted by WPC/Statutory Bodies in country of deployment as applicable).</li> <li>• DCU shall periodically monitor meter reads/downstream commands and shall retry and reconnect in case of failed events/reads.</li> <li>• It shall push events such as tamper, power off etc. to HES immediately on occurrence/receipt from field devices/meters. DCU shall be able to acquire and send data to HES for full capacity (as per designed for no. of meters/field devices) to ensure the performance level. Full capacity of DCU is required to be indicated in the offer.</li> <li>• After Power Interruption, on restoration of power supply, DCU shall establish communication with underlying devices as well as upstream application automatically.</li> <li>• DCU shall be able to communicate with the nearest meters depending on topographical features. For further communication among the meters, distance of the other meters with the DCU shall not be a constraint as communication of the nearest meters shall be established with other meters through appropriate mesh formation / other formation.</li> <li>• Remote Firmware Upgrade: The DCU shall support remote firmware upgrades as well as remote configuration from the network operation cum monitoring center. Configuration of programmable parameters of Smart Meters shall be done through HES.</li> <li>• All meters falling under one DCU shall be commissioned and checked for proper communication in presence of <b>MVVNL</b> in-charge.</li> </ul>	



## Section 4. Technical Proposal –Forms

S. No.	Description of the Features	Minimum Requirement of Features	As per Bidder Offering
		<ul style="list-style-type: none"> <li>• DCU shall keep the records of minimum of the following events:               <ul style="list-style-type: none"> <li>○ No of packet failures</li> <li>○ Retry attempts</li> <li>○ Missed periodic readings</li> <li>○ Failure to connect</li> <li>○ Tamper events</li> </ul> </li> </ul>	

**Head-End System (HES)**

S. No.	Description of the Features	Minimum Requirement of Features	As per Bidder Offering

**Firewall and Intrusion Protection System**

S. No.	Description of the Features	Minimum Requirement of Features	As per Bidder Offering

**Internet Router**

S. No.	Description of the Features	Minimum Requirement of Features	As per Bidder Offering

**Local Area Network**

S. No.	Description of the Features	Minimum Requirement of Features	As per Bidder Offering

**Form 22: Manufacturer Authorisation Form (MAF)***(On Letterhead of each OEM)*To: [Insert: Name of **MVVNL**]

Dear Sir/Ma'am,

We [insert: name of Manufacturer] who are established and reputable manufacturers of [insert: name and/or description of the plant & equipment] having production facilities at [insert: address of factory] do hereby authorize [insert: name & address of Bidder] (hereinafter, the "Bidder") to submit a bid, and subsequently negotiate and sign the Contract with you against [insert: title and reference number of Invitation for Bids] including the above goods and services.

We hereby extend our full guarantee and warranty for the above specified plant & equipment materials or other goods offered supporting the supply, installation and achieving of Operational Acceptance of the plant by the Bidder against these Bidding Documents, and duly authorize said Bidder to act on our behalf in fulfilling these guarantee and warranty obligations. We also hereby declare that we and ....., [insert: name of the Bidder] have entered into a formal relationship in which, during the duration of the Contract (including warranty / defects liability) we, the Manufacturer or Producer, will make our technical and engineering staff fully available to the technical and engineering staff of the successful Bidder to assist that Bidder, on a reasonable and best effort basis, in the performance of all its obligations to the Purchaser under the Contract.

For and on behalf of [insert: name of Manufacturer]

Signed: \_\_\_\_\_

Date: \_\_\_\_\_

In the capacity of [insert: title of position or other appropriate designation] and this should be signed by a person having the power of attorney to legal bind the manufacturer.

Date:.....

Place:..... (Signature).....

(Printed Name).....

(Designation).....

(Common Seal).....

Note:

1. The letter of Undertaking should be on the letterhead of the Manufacturer and should be signed by a person competent and having Power of Attorney to legally bind the Manufacturer. It shall be included by the Bidder in its bid.
2. Above undertaking shall be registered or notarized so as to be legally enforceable.

### Annexure: Illustration for Applicable Board Resolution Requirements Under Clause 15 of Section 3

**Table: Bill of Materials and Services for Smart Meters. To be filled by AMISP. The Total Quantity of Smart Meters and Lumpsum (Rs. 900/- each type per meter) payment amount to be defined by the **MVVNL****

Investor in the AMISP	Entities (other than Bidder) whose credentials (financial and/or technical) used by the Bidder for meeting RFP criteria	Applicable Board Resolutions	Requirement of Undertaking (Form 18)
Bidder himself for 100% equity Meter	None	a) Format I of Annexure 11- Resolution:1,2 and 4 from the Bidder	None
Bidder himself for 100% equity Meter	Affiliate and/or Parent Company and/or Ultimate Parent	<p>a) Format I of Annexure 11 - Resolution: 1, 2, and 4 from the Bidder</p> <p>b) Format 2 of Annexure II by either Technically/ Financially Evaluated Entity(ies) whose credentials have been used, or Ultimate Parent.</p> <p>Provided. If the Bidder himself is the Ultimate Parent, then Format 2 need not be provided.</p>	<p>Yes, by either Technically / Financially Evaluated Entity(ies) Affiliate(s) whose credentials have been used, or Ultimate Parent.</p> <p>Provided, if the Bidder himself is the Ultimate Parent, then the undertaking need not be provided.</p>

## Section 4. Technical Proposal –Forms

Investor in the AMISP	Entities (other than Bidder) whose credentials (financial and/or technical) used by the Bidder for meeting RFP criteria	Applicable Board Resolutions	Requirement of Undertaking (Form 18)
Bidder himself + others (Affiliate and/or Parent Company and/or Ultimate Parent) in aggregate holding 100% equity	None	a) Format 1 of Annexure 11 - Resolution: 1, 2, 3 And 4 from the Bidder. b) Format I of Annexure 11 - Resolution: I from the Affiliate and /or Parent and /or Ultimate Parent investing in the equity	None
Bidder himself + Others (Affiliate and/or Parent Company and/or Ultimate Parent) in aggregate holding 100% equity	Affiliate and/or Parent Company and/or Ultimate Parent	a) Format 1 of Annexure 11 - Resolution: 1,2, 3 and 4 from the Bidder. b) Format I of Annexure 11 - Resolution: I from the Affiliate and/or Parent and/or Ultimate Parent investing in the equity c) Format 2 of Annexure 11 by either Parent / Affiliate(s) whose credentials have been used and /or Ultimate Parent investing in the equity	Yes, by either Parent/ Affiliate(s) whose credentials have been used, or Ultimate Parent

## Form 23: Format of Agreement to be entered by sub-contractors with the sole bidder / lead member of a Bidding Consortium

*[To be on non-judicial stamp paper of Rupees One Hundred Only (INR 100/-) or appropriate value as per Stamp Act relevant to place of execution, duly signed on each page. Foreign entities submitting Bid are required to follow the applicable law in their country.]*

### FORM OF AGREEMENT BETWEEN

M/s....., AND M/s. .... for bidding for Tender No. [Tender Details] (the “RFP”) dated [Date] as per its Clause 4.3.2

1. **THIS Agreement** (hereinafter referred to as “Agreement”) executed on this ..... [date] day of ..... [month], ..... [year] between
2. M/s. ...., a company incorporated under the laws of ..... and having its Registered Office at ....., (hereinafter called “**Party 1,**” or “**Lead Consortium Member**” or “**Sole Bidder**” which expression shall include its successors, executors and permitted assigns);
3. M/s. ...., a company incorporated under the laws of ..... and having its Registered Office at ....., (hereinafter called “**Party 2,**” or “**Sub-contractor**” which expression shall include its successors, executors and permitted assigns);

*[The Sub-contractor should list the name, address of its registered office and other details above.]*

WHEREAS the Parties abovenamed are entering into this Agreement for the purpose of submitting the Bid in response to the RFP and in the event of selection as Selected Bidder to comply with the requirements as specified in the RFP and ensure execution of the AMISP Contract as may be required to be entered into with **MVVNL**.

Party 1, and Party 2, are hereinafter collectively referred to as the “Parties” and individually as a “Party.

**WHEREAS** the RFP stipulates that the sub-contractors shall submit a legally enforceable Agreement in a format specified in the RFP, whereby each sub-contractor undertakes to be liable for its Roles and Responsibilities, provide necessary guarantees and pay required fees as required as per the provisions of the RFP, as specified herein.

**WHEREAS** any capitalized term in this Agreement shall have the meaning ascribed to such term in the RFP document.

### **NOW THEREFORE, THIS AGREEMENT WITNESSTH AS UNDER:**

In consideration of the above premises and agreement all the Parties in this Consortium do hereby mutually agree as follows:

17. In consideration of the selection of the bidder by the **MVVNL**, we as the sub-contractor to the sole bidder/ lead member of the bidding Consortium and Party to this Agreement do hereby unequivocally agree that M/s..... [Insert name of the Sole bidder/ Lead Member of the bidding consortium], shall act as the Lead Member as defined in the RFP for self and agent for and on behalf of M/s. ...., [the name of the sub-contractor to be filled in here].

18. The Roles and Responsibilities of the sub-contractor shall be as per the **Annexure** to this Agreement.
19. The sub-contractor undertakes to be individually liable for the performance of its part of the Roles and Responsibilities without in any way limiting the scope of collective liability envisaged in this Agreement in order to meet the requirements and obligations of the RFP. The Sole bidder/ Lead Consortium Member shall be liable and responsible for ensuring the individual and collective commitment of the sub-contractor in discharging their respective Roles and Responsibilities.
20. In case of any breach of any of the commitment as specified under this Agreement by the sub-contractor, the Sole bidder/ Lead Consortium Member shall be liable to meet the obligations as defined under the RFP.
21. Except as specified in the Agreement, it is agreed that sharing of responsibilities as aforesaid and obligations thereto shall not in any way be a limitation of responsibility of the Sole bidder/ Lead Consortium Member under these presents.
22. The Members expressly agree to adhere to all the terms and conditions of the RFP and confirm that we don't have any Conflict of Interest (as defined in the RFP).
23. This Agreement shall be construed and interpreted in accordance with the Laws of India and Courts at [Place] shall have the exclusive jurisdiction in all matters relating thereto and arising there under.
24. It is further expressly agreed that the Agreement shall be irrevocable and, for the AMISP, shall remain valid over the term of the Project, unless expressly agreed to the contrary by **MVVNL**.
25. The Sole bidder/ Lead Consortium Member is authorized and shall be fully responsible for the accuracy and veracity of the representations and information submitted by the Sub-contractor respectively from time to time in response to the RFP for the purposes of the Bid. The representation by the Sole bidder/ Lead Consortium Member shall be deemed to be on behalf of and binding on the sub-contractor.
26. It is expressly understood and agreed between the Sole bidder/ lead consortium member and the sub-contractor that the responsibilities and obligations of each of the Members shall be as delineated as annexed hereto as Annexure-A forming integral part of this Agreement. It is further agreed by the Members that the above sharing of responsibilities and obligations shall not in any way be a limitation of responsibilities and liabilities of the Members, with regards to all matters relating to the execution of the Bid and implementation of the Project envisaged in the RFP Documents.
27. It is clearly agreed that the Sole Bidder/ Lead Consortium Member shall ensure performance indicated in the RFP. In the event the sub-contractor fails to perform its/ their respective obligations, the same shall be deemed to be a default by the Sole Bidder/ Lead Consortium Member.

Section 4. Technical Proposal –Forms

28. It is hereby expressly agreed between the Parties to this Agreement that neither Party shall assign or delegate or subcontract its rights, duties or obligations under this Agreement to any person or entity except with prior written consent of **MVVNL**.

29. This Agreement:

- a) has been duly executed and delivered on behalf of each Party hereto and constitutes the legal, valid, binding and enforceable obligation of each such Party;
- b) sets forth the entire understanding of the Parties hereto with respect to the subject matter hereof; and
- c) may not be amended or modified except in writing signed by each of the Parties and with prior written consent of **MVVNL**.

Common Seal of ..... has been affixed in my/ our presence pursuant to Board Resolution dated .....	For M/s. .... (Party 1) <i>[Signature of Authorized Representative]</i> ..... <i>[Name of the Authorized Representative]</i> <i>[Designation of the Authorized Representative]</i>
--	--

Witness 1

[Signature of Witness 1]

.....

Name:

Designation  Witness 2  [Signature of Witness 2] ..... Name: Designation:  ..	
--	--

N. Common Seal of ..... has been affixed in my/ our presence pursuant to Board Resolution dated .....	For M/s. .... (Party 2) <i>[Signature of Authorized Representative]</i> ..... <i>[Name of the Authorized Representative]</i> <i>[Designation of the Authorized Representative]</i>
---	--

N.1. Witness 1  [Signature of Witness 1] ..... Name: Designation:	N.2. Witness 2  [Signature of Witness 1] ..... Name: Designation:
--	--

**Annexure-A**

Role and Responsibility of each Member of the Consortium:

1. Roles and Responsibilities of the Party 1 (Sole Bidder/ Lead Consortium Member):
2. Roles and Responsibilities of the Party 2 (Sub-contractor)



## Section 5. Financial Proposal - Forms

Sr.	Document	Attached? (Yes/ No)	For Official Use
1	Financial Bid as per format provided in Form 1		

**Form 1: Format of Submission of Financial Bid (For Reference Only)**

***[IMPORTANT NOTE: THE FINANCIAL BID SHALL ONLY BE SUBMITTED IN THE ELECTRONIC FORMAT. IT SHALL NOT BE SUBMITTED IN HARD COPY OR AS A PART OF THE TECHNICAL BID.]***

[On the letter head of each Member of the Consortium including Lead Member/ Sole Bidder]

[Reference No.]

From:

[Address of the Lead Consortium Member/ Sole Bidder]

[Telephone No., Fax No., Email]

[Date]

To:

[Address]

**Sub: Financial Bid for Appointment of AMISP for Smart Prepaid Metering on DBFOOT basis.**

*Ref: [Tender Details]*

Dear Sir/ Madam,

We, the undersigned ..... [Insert name of the Lead Consortium Member/ Sole Bidder 'Party 1'] representing ..... [Insert name of the Lead Consortium Member 'Party 2'], ..... [Insert name of the Lead Consortium Member 'Party 3'], ..., and ..... [Insert name of the Lead Consortium Member 'Party n'], having read, examined and understood in detail the RFP for Implementation of [MVVNL]'s AMI hereby submit our Financial Bid. We hereby undertake and confirm that:

- A. We have submitted our Financial Bid strictly in accordance with the RFP without any deviations or condition.
- B. Our Financial Bid is consistent with all the requirements of submission as stated in the RFP and subsequent communications.
- C. Price quoted clearly mentions the total cost (basic cost, Goods and Services Tax, or any other taxes/duties/levies).
- D. Under no circumstances shall escalation in prices of this Financial Bid be entertained by [MVVNL] except due to factors mentioned in Clause 5.3.3. of Section 7.
- E. The details quoted herein shall stand valid at least for 6 months from the date of submission of this Financial Bid and for implementation of Project, if awarded, as per the timeframe indicated in the RFP.

## Section 5. Financial Proposal –Forms

F. Our Total Cost of the Project for the contract period is INR.....; and the quoted AMISP Service Charge will be a fixed for the entire contract duration

G. Our quoted prices are as per the Annexure attached herein.

Dated the ..... [Insert date of the month] day of ..... [Insert month, year] at ..... [Insert place].

Thanking you,

Sincerely yours,

[Insert Signature here]

[Insert Name here]

[Insert Designation here]

### Annexure: Quoted prices for the Financial Bid.

<Please Note: The list is indicative only. This needs to be detailed out and customized by **MVVNL** basis project requirement. The quantity of smart meters to be installed should be based upon As-Is consumer database as well as projected load growth in the selected AMI Project Area during the Contract Period. Any variation in GST and or cess on the Items specifically mentioned above shall be on account of the **MVVNL** and not other items including hardware and software that may be necessary for putting the AMI system in place>

**Table : Bill of Materials and Services for Smart Meters. To be filled by AMISP. The Total Quantity of Smart Meters and Lumpsum (Rs. 900/- each type per meter) payment amount to be defined by the **MVVNL****

Smart Meter details in EXHIBIT-1

S. No.	Item Description (A)	Quantity in Nos. (B)	Rate per Unit including all taxes and duties other than GST (in INR/month/meter) (C)	GST applicable in % (D)	AMISP Service Charge (in INR/month/meter) (E) = C x (1+D%)	Lumpsum (Rs. 900/-) payment per Unit (in INR/ meter) (F)	Total cost for each category of meter (G = BX ((E X 90 months) +F))
<b>1. Meters (each with related meter box, hardware, software and equipment)</b>							
1.1	Single phase whole current Smart Meter (without Net-Metering) – Consumer Meter with Meter Box, Back-end IT Infra with associated works and requisite no. of polycarbonate seal						
1.2	Single phase whole current Smart Meter (with Net-Metering) – Consumer Meter with Meter Box and Back-end IT Infra with associated works and requisite no. of polycarbonate						

As per EXHIBIT-1

S. No.	Item Description (A)	Quantity in Nos. (B)	Rate per Unit including all taxes and duties other than GST (in INR/month/meter) (C)	GST applicable in % (D)	AMISP Service Charge (in INR/month/meter) (E = C x (1+D%))	Lumpsum (Rs. 900/-) payment per Unit (in INR/ meter) (F)	Total cost for each category of meter (G = BX ((E X 90 months) +F))
	seal						
1.3	Three Phase whole current Smart Meter (without Net-Metering) – Consumer Meter with Meter Box and Back-end IT Infra with associated works and requisite no. of polycarbonate seal						
1.4	Three Phase whole current Smart Meter (with Net-Metering) – Consumer Meter with Meter Box and Back-end IT Infra with associated works and requisite no. of polycarbonate seal						
1.5	Three phase LT-CT operated Smart Meter (without Net-Metering) – Consumer Meter with CTs, control cables, without DI provisions Meter Box and Back-end IT Infra with associated works and requisite no. of polycarbonate seal						

**As per EXHIBIT-1**

S. No.	Item Description (A)	Quantity in Nos. (B)	Rate per Unit including all taxes and duties other than GST (in INR/month/meter) (C)	GST applicable in % (D)	AMISP Service Charge (in INR/month/meter) (E = C x (1+D%))	Lumpsum (Rs. 900/-) payment per Unit (in INR/ meter) (F)	Total cost for each category of meter (G = BX ((E X 90 months) +F))
1.6	Three phase LT-CT operated Smart Meter (with Net-Metering) – Consumer meter with CTs, control cables, without DI provisions Meter Box and Back-end IT Infra with associated works and requisite no. of polycarbonate seal						
1.7	Three phase LT-CT operated Smart Meter (with Net-Metering) – DT Meter with CTs, control cables, with DI provisions Meter Box and Back-end IT Infra with associated works and requisite no. of polycarbonate seal			<b>As per EXHIBIT-1</b>			
1.8	Three phase LT-CT operated Smart Meter – Boundary Meter with CTs, control cables, with DI provisions Meter Box and Back-end IT Infra with associated works and requisite no. of polycarbonate seal						

S. No.	Item Description (A)	Quantity in Nos. (B)	Rate per Unit including all taxes and duties other than GST (in INR/month/meter) (C)	GST applicable in % (D)	AMISP Service Charge (in INR/month/meter) (E = C x (1+D%))	Lumpsum (Rs. 900/-) payment per Unit (in INR/ meter) (F)	Total cost for each category of meter (G = BX ((E X 90 months) +F))
1.9	Three phase CT/PT operated Smart Meter – Feeder Meter with CTs, control cables, with DI provisions Meter Box and Back-end IT Infra with associated works and requisite no. of polycarbonate seal						
1.10	....						
	<b>Total</b>						

As per EXHIBIT-1

**Section B: Auxiliary LT items: ~~Main Service Distribution Box~~, DT Cable Service Cable Supply, Installation, Commissioning & other services**

S. No.	Item Description (H)	Quantity in Nos. (I)	Rate per Unit including all taxes and duties other than GST (in INR) (J)	GST applicable in % (K)	Total cost (L = I X J X (1+K))
3.	<del>Main Service Distribution Box</del> , Service Cable Supply, Installation, Commissioning & other services				
3.1	<del>SMC Main Service Distribution Box (MSDB)</del>	To be provided by Utility			
3.2	4 core 35 mm <sup>2</sup> XLPE Cable [ @ 2 meter per connection ]	To be provided by Utility			
3.3	2C*6 mm <sup>2</sup> Cable, 1.1k V Grade, Un-Armored, XLPE Insulated Stranded Conductor FRLS type for pole mounted for Single Phase [ @ 20 meter per connection ]	As per EXHIBIT-1			
3.4	4C*16 mm <sup>2</sup> Cable, 1.1k V Grade, Armored, XLPE Insulated Stranded Conductor FRLS type for pole mounted for Three Phase [ @ 20 meter per connection ]	As per EXHIBIT-1			
4.5	....				
5.	DT Cable Supply, Installation, Commissioning & other services				
5.1	....				
	<b>Total</b>				

**Section C: New requirement for Software Components**

S. No.	Item Description (H)	Total Estimated Person Days Required (I)	Person Day Rate (J)	Total Cost (K= I X J)
6	New requirement for software components			
6.1	Architecture Specialists (Experience- 10+ years)	As per EXHIBIT-1		
6.2	Security Specialists (Experience- 10+ years)	As per EXHIBIT-1		
6.3	Integration Specialists (Experience- 10+ years)	As per EXHIBIT-1		



S. No.	Item Description (H)	Total Estimated Person Days Required (I)	Person Day Rate (J)	Total Cost (K= I X J)
6.4	Data Base Developer- Sr. (Experience- 5+ years)	As per EXHIBIT-1		
6.5	Web/ Mobile Application Developer- Sr. (Experience- 5+ years)	As per EXHIBIT-1		
6.6	Core Application Developer- Sr. (Experience- 5+ years)	As per EXHIBIT-1		
6.7	Data Base Developer- Jr. (Experience- Less than 5 years)	As per EXHIBIT-1		
6.8	Web/ Mobile Application Developer- Jr. (Experience- Less than 5 years)	As per EXHIBIT-1		
6.9	Core Application Developer- Jr. (Experience- Less than 5 years)	As per EXHIBIT-1		
	<b>Total</b>			

**Total Cost of the Project** (Sub-total of Column G and L in tables above) = INR [X] crores .>

## Section 6. Project Requirements

### AMI System Requirements and Service Level Agreement

#### Table of Contents

1.	Overview of the AMISP Scope of Work.....	155
2.	Supply, installation, integration, testing and commissioning of:.....	162
3.	AMI System Integrations.....	210
4.	Consumer Indexing .....	212
5.	Consumer Engagement.....	214
6.	Analytics and Reports .....	215
7.	Operation and Maintenance .....	220
8.	Training Requirements .....	229
9.	Tests, Inspections and Management of the Quality Assurance / Quality Control Program.....	232
10.	Project Management.....	251
11.	Document Requirements .....	253
12.	Project Implementation Schedule .....	256
13.	Annexures .....	258

## 1. Overview of the AMISP Scope of Work

**1.1** “Advance Metering Infrastructure Service Provider (AMISP)” or the “AMISP” shall Design, Build, Finance, Own, Operate, Transfer (DBFOOT) the Advance Metering Infrastructure (AMI) Project in the pre-paid (by default) mode in selected AMI Project Area. The AMISP shall finance and implement the project including **end-to-end smart metering**, operate for ‘Total Meter-months’ as defined in this Contract and thereafter transfer the ownership of the entire system including all the hardware, software along with its valid licenses, and any data collected during the Project to the **MVVNL** at the end of the Contract Period to facilitate seamless operation of **MVVNL** businesses. **MVVNL** shall make payments to the AMISP in accordance with the terms and conditions of this Contract.

### 1.2 The AMI Project Area

The AMI Project shall be implemented in the Project Area comprising contiguous electrical locations (which will be ring fenced with boundary meters) where all consumers, DTs, feeders shall be smart metered to enable complete energy accounting with zero manual intervention and non-contiguous electrical locations where dispersed metering for certain Industrial, Commercial and Government consumers shall be done.

[Profile of Project area. The key details include following:

#### **A) Contiguous Electrical Locations:**

- a) Geographical Boundary: **Phase wise Details of Divisions (EXHIBIT-2)**
- b) Number of single phase whole current Smart Meters (with/without net-metering), three phase whole current Smart Meters (with/without net-metering), LT-CT operated three phase Smart Meters (with/without net-metering), and CT/PT operated three phase Smart meters to be installed,

#### **AS PER EXHIBIT-1**

*<The total number of smart meters to be installed should be based upon As-Is consumer database as well as projected load growth in the selected AMI Project Area during the Contract Period. Accordingly, the **MVVNL** should provide the appropriate quantity of smart meters to be installed for the AMI project based on the above consideration in Form 1 (Financial Bid) given in Section 5 of the RfP. AMISP shall provide meter LTCTs for LTCT meters as per the specifications provided by the **MVVNL**. **MVVNL** shall provide CTPTs to AMISP for HT-CTPT meters. In case **MVVNL** require AMISP to procure meter HT-CTPTs, the number and specifications for the same need to be provided by the **MVVNL**>*

- c) Total number of consumer by category (Domestic/ Industrial/ Commercial/ Government);
- d) Substation information;
- e) Feeder information;
- f) DT information;
- g) AT&C loss information (including billing and collection efficiency)
- h) Historical load growth in project area;
- i) Manpower deployed in the selected area(s) of operations;

#### **B) Non-Contiguous Electrical Locations:**

- a) Geographical Boundary:

- b) Number of single phase whole current Smart Meters (with/without net-metering), three phase whole current Smart Meters (with/without net-metering), LT-CT operated three phase Smart Meters (with/without net-metering), and CT/PT operated three phase Smart meters to be installed;

~~<The total number of smart meters to be installed should be based upon As Is consumer database as well as projected load growth in the selected AMI Project Area during the Contract Period. Accordingly, the Utility should provide the appropriate quantity of smart meters to be installed for the AMI project based on the above consideration in Form 1 (Financial Bid) given in Section 5 of the RfP. AMISP shall provide meter LTCTs for LTCT meters as per the specifications provided by the Utility. Utility shall provide CTPTs to AMISP for HT CTPT meters. In case Utility require AMISP to procure meter HT CTPTs, the number and specifications for the same need to be provided by the Utility>~~

- c) Total number of consumer by category (Industrial/ Commercial/ Government);
- d) Substation information;
- e) Feeder information;
- f) DT information;
- g) Historical load growth in project area;
- h) Manpower deployed in the selected area(s) of operations;

**C) Other Details:**

- a) Details regarding periodicity/ frequency of the integration, data parameters including feeder energy data/ formats to be sent and received, protocol(s) to identify and address exceptions, and concurrency requirements;

Consumer Data : As per SLA

DT Meter Data : As per SLA

Feeder Meter Data : As per SLA

- b) Details on requirement of infrastructure for recharge through feature phones/ offline channels required by the **MVVNL**.

<Assumption based on one kiosk per existing bill pay centre for a period of 3(three) years>]

- 1.3** The AMI system should be designed such that all the required hardware, software, and firmware with upgrades satisfy the AMI system requirements and service level agreements as specified in this Contract while considering technical obsolescence over the operating life of the system and suitability for future scale up. AMISP is free to decide upon the best solution out of all the available options. However, the entire responsibility of fully functional AMI system shall rest with the AMISP in order to meet the performance levels as given in the Contract. The AMISP shall ensure that the Solution complies with the Applicable Law, technical specifications and other provisions of the Contract.

**1.4 Brief Scope of Work:**

The Scope of work of AMISP shall include site survey, planning, designing, financing, engineering, manufacturing, supply, transportation & insurance, delivery at site, unloading, handling, storage, installation, integration, testing, commissioning, demonstration for acceptance, training, maintenance, operation and documentation of various AMISP components given below:

- 
- A. Supply, installation, integration, testing and commissioning of:
- a. Smart pre-paid metering along with Smart meter box installation and service cable for consumers, DTs and Feeders through 1-Ph, 3-Ph and LTCT as per Clause 2.1 of this Section.
  - b. Communication Infrastructure to ensure the performance levels provided in this Contract as per Clause 2.2 of this Section;
  - c. Head End System (HES) and deployment on cloud as per Clause 2.3 of this Section;
  - d. Meter Data Management system (MDM) with prepaid functionality (as a part of MDM or through a separate pre-payment application) and deployment on cloud as per Clause 2.4 of this Section;
  - e. Consumer portal and mobile application as per Clause 2.5 of this Section;
  - f. Network Operation cum Monitoring Centre (NOMC) with suitable backend communication infrastructure, hardware and power supply as per Clause 2.6 of this Section;
  - g. All other necessary software along with valid licenses relevant to the Project (as per Clause 2.7 of this Section);
  - h. Installation of ~~Distribution Box~~ and laying of service cable from LT line to meter and from Meter to consumer premises, removal of existing cable, if required, connection, taping, Laying of DT cables from DT through LTCT meters to LTDB/Fuse Box, wherever applicable. Material, tools and other accessories (not covered in BoQ) required for dismantling, civil work and installation of the new, shall also be in the scope of agency.
  - i. Installation of 9x1 Cabinet boxes with requisite cabling wherever applicable.
- B. AMI System integration as per Clause 3 of this Section;
- C. Consumer indexing on de-novo basis for contiguous electrical locations in the selected AMI Project Area along with its regular updates during contract period as per Clause 4 of this Section;
- D. Development of a comprehensive consumer engagement plan (as per Clause 5 of this Section) related to different stages of implementation (Pre, during and post installation phases of smart metering) in consultation with **MVVNL** and implement its part of its activities as per the developed plan. The plan at the minimum should include consumer engagement activities to be undertaken at **MVVNL**'s headquarter, division and sub-division level as well as communication and media plan;
- E. Generation of automated energy audit reports (DT level/ Feeder level / Sub-division level/ Division level/ Circle) in contiguous electrical locations and other reports as per Clause 6 of this Section;
- F. Operation, maintenance, and support services after the successful completion of the Operational Go-Live of the system as per Clause 7 of this Section;
- G. Training of **MVVNL** personnel, as required for efficient, viable and fully functional system as per Clause 8 of this Section.
- H. Other activities to be carried out to ensure successful installation and commissioning:
- a. Dismantling of existing meter boxes and other scrapped service cables from site and erection and commissioning of service cable and meter boxes along with necessary items like CT'S, lugs etc. as per the guidelines of the **MVVNL**. The installation work of meter boxes, cables etc. should be carried out as per the safety guidelines of the **MVVNL**, while meeting all requisite quality standards.

- 
- b. All meter installations at user accessible height or consumer premises shall preferably be installed with Armoured service cable from LT line to Meter while at un-accessible height such as poles etc., these may be installed with Un-Armoured Service Cable from LT Line to Meter. The service cable installation from Meter to Consumer premises shall be Un-Armoured in all case. The above may be reviewed on case-to-case basis with inputs from the **MVVNL**.
  - c. All the associated necessary civil work for dismantling existing structures / equipment and to put in place the new structures / equipment, shall be carried by the AMISP.
- 1.5** Guidelines for testing, inspection, approval of test records and in general, management of the Quality Assurance / Quality Control program of the AMI project as given in Clause 9 of this Section shall be generally adhered to.
- 1.6** Guidelines for project management as given in Clause 10 shall generally be adhered to.
- 1.7** The AMISP shall be required to submit project documentation describing the system operations for information/ approval as per Clause 11 to the **MVVNL**.
- 1.8** Unless otherwise stipulated in the RfP or Contract, the scope of work shall include all such items not specifically mentioned in the Contract but that can be reasonably inferred from the Contract as being required for comprehensive, successful and satisfactory implementation of the Solution as if such items were expressly mentioned in the Contract. The same may be mutually enlisted and agreed upon by **MVVNL** and AMISP during the design phase as defined in the Contract;
- 1.9** Wherever references are made in the RfP to codes and standards in accordance with which the Solution shall be executed, the edition or the revised version of such codes and standards shall be those specified in the scope of work;
- 1.10** The systems which are at a risk of technical obsolescence over the operating life of the system should be identified; this should include end-of-sale and end-of-support policies governing the proposed technologies. Forward and backward compatibility need to be considered and mitigation option shall be indicated in detail and shall not be limited to periodic update from OEM/System supplier
- 1.11 Exclusion from Scope of Work:** Following shall be excluded from AMISP's scope of work
- a. Construction of building for AMI Network Operation cum Monitoring Centre;
  - b. Lighting system for AMI Network Operation cum Monitoring Centre;
  - c. Interior and Integrated Building Management System (IBMS) of building for AMI Network Operation cum Monitoring Centre;
  - d. Air conditioning and ventilation for AMI Network Operation cum Monitoring Centre;
  - e. Firefighting system for AMI Network Operation cum Monitoring Centre;
  - f. A.C. input power and back-up supply for AMI Network Operation cum Monitoring Centre;
  - g. Any modifications required in the existing system of the **MVVNL** (Billing, Website, etc.).
- 1.12 Responsibilities of the **MVVNL****
- The Chairman/ Managing Director of **MVVNL** or any other person designated by the Chairman/ Managing Director of **MVVNL** shall act as the nodal point for the implementation of the Contract and for issuing necessary instructions, approvals, commissioning, acceptance certificates, payments etc. to the AMISP.

The **MVVNL** shall:

- a) Whenever implementation of any component of the Solution requires that the AMISP obtain permits, approvals, and import and other licenses from local public authorities, if so required by the AMISP, make its best effort to assist the AMISP in complying with such requirements in a timely and expeditious manner;
- b) Erection of requisite structure for installation of boundary meters and corresponding ringfencing of Project Area
- c) approve all such documents required for completion of Pre-Operational Go-Live Phase, in accordance with Clause 11 of this Section, within 15 (fifteen) working days from the date of submission of such documents;
- d) Provide on AMISP's request, particulars/ information / or documentation that may be required by the AMISP within 30 (thirty) days from date of execution of the Contract to enable preparation of the Project Implementation plan by the AMISP;
- e) Provide existing database of consumer indexing and physical & IT infrastructure as available with the **MVVNL**. **MVVNL** shall provide all required data to the AMISP to identify all the consumers connected on the identified sub-stations, feeder lines and transformers of the AMISP Project area;
- f) Review and approval of AMISP's Project Implementation Plan;
- g) Provide drawings for NOMC building where AMI system installations are planned;
- h) Provide necessary inputs for developing a comprehensive consumer engagement plan;
- i) Provide necessary approvals for shutdowns as required for implementing the AMI System;
- j) *[Storage and disposal of replaced old meters];*  
Or  
*[Coordinate with AMISP for disposal of replaced old meters]*<sup>3</sup>
- k) Implement consumer engagement plan with support of AMISP. This would include running media campaign to raise awareness and countering myths around smart metering prior to installation, providing SOPs for smart meter installation to AMISP, etc.
- l) Keep AMISP informed of any changes in the area network during the project installation and operation period. Furthermore, **MVVNL** will partner with AMISP for discovering/ updating consumer indexing (DT/ Feeder wise) after installation of smart meters through structured power events data analysis including scheduling such events for each node with minimum inconvenience to consumer
- m) Provide A.C. power supply inputs
- n) Provide all required documents for delivery of material at site
- o) Provide at its expense, the electrical energy required for performance of the Project activities, installation, testing, and operation of the AMI Systems
- p) Providing support and access to facilities at the sites, including consumer premises
- q) Arrange for necessary shutdowns and work permits
- r) Implement major civil works such as expansions or construction of rooms, trenches etc. as required for the AMI equipment
- s) Ensure that sites for installation for Smart Meters are ready along with service cable including electrical neutral connectivity to the transformer, wherever applicable, for AMISP;

<sup>3</sup> **MVVNL**/**MVVNL** to select one of these two and accordingly provide clear directions on the same as well as select **relevant point 3.3.1.b**

- 
- t) Provide the required integration interface details of the existing billing enterprise and related information required for Operational Go-Live of the AMI system, within 6 (six) months from date of execution of the Contract
  - u) Provide necessary clearance/ approval/ permits that are to be issued by it for initial 20% of contiguous electrical locations for Smart Meter deployment along with related documentation within 6 (six) months from date of execution of this Contract. Provide necessary clearance/ approval/ permits to be issued by it for remaining contiguous electrical locations as well as non-contiguous electrical locations for Smart Meter deployment along with related documentation on quarterly basis. **MVVNL** shall endeavor to provide 20% of contiguous electrical locations cleared each quarter and complete area within 18 (eighteen) months from date of execution of the Contract. **MVVNL**/MVVNL shall issue a Notice (provided if the **MVVNL**/MVVNL has not been able to provide clearance/ approval/ permits for installation of the meters) no later than 7 days of expiry of time period specified above confirming the actual number of meters for which clearance/ approval/ permits is available
  - v) Review the specifications of the Goods proposed to be used to ensure compliance with the provisions of this Contract.
  - w) Provide reasonable support to the AMISP for the Operational Go-Live in terms of the provisions of this Contract
  - x) Provide necessary support to AMISP in the Project area, in relation to (amongst others) access to **MVVNL**'s/consumers premises, installation of AMI system, repair and maintenance services, etc. **MVVNL** shall also:
    - i. Give access to AMISP supervisor or its operation & maintenance staff to work in the Project area during the Contract Period;
    - ii. Provide an office space for AMISP personnel as mentioned in Clause 10 of this Section document within the **MVVNL** premises.
    - iii. Give access to AMISP to use existing power and water supply, and other necessary equipment, as mutually agreed with the AMISP;
    - iv. Not move, remove, modify, alter, or change the AMI system or any part thereof in the boundary of the AMI system installed by the AMISP without the prior written consent of AMISP. **MVVNL** shall take all reasonable steps to protect the AMI system from damage or injury and shall follow procedure for emergency action provided in advance by AMISP
  - y) Participate in periodic review meetings as per the project governance structure, and shall support with the required interventions requested;
  - z) Be responsible for operation and maintenance of power supply system, and promptly attend to any break down including repair or replacement of any equipment used/needed for maintaining continuity of electricity supply for AMI system operation;
  - aa) Permit AMISP to perform the project activities during working hours, and also after working hours as necessary, to meet the requirements of Project Implementation Plan;
  - bb) Provide necessary support in creation of pre-payment infrastructure;
  - cc) Attend to any irregularity with respect to AMI system operation, the cause of which has been brought to its attention by the AMISP;
  - dd) Promptly notify the AMISP of any events or circumstances that could affect the Project outcomes, or the AMISP's Services and obligations under this Contract;
  - ee) Allow AMISP (and/or its implementation partner, investor(s), authorized agency) unfettered access to network operation cum monitoring centre. Such covered and enclosed space as required by AMISP shall be provided to it by **MVVNL** free of cost during the Contract Period;



- ff) Cooperate with AMISP in arranging financing for the Project, including by signing any relevant documents (such as substitution Contract) and providing such approvals, no-objections and waivers as may be required by investors/lenders;
  - gg) Appoint and notify to AMISP of the names and contact details of the **MVVNL** representative and its dedicated staff for the Project, which would include:
    - i. An engineer-in-charge for the Project who shall render full support to AMISP for Service delivery during the Term of this Contract and shall coordinate for payment to AMISP;
    - ii. A nodal officer, **MVVNL** Project Manager, to co-ordinate with AMISP in relation to the Project.
  - hh) Maintain consumer expectations basis the consumer engagement plan;
  - ii) Certify Installation Milestone in accordance with the provisions of this Contract.
  - jj) Facilitate AMISP for the timely implementation of the AMI Project and for its successful operation and maintenance during the Contract Period
  - kk) Release payments to AMISP as per agreed terms
  - ll) At its own cost, replace or repair existing equipment (other than AMI systems), such as poles, cables including consumer service lines, and transformers etc. where necessary to make the AMI system operational and/ or safe from hazards and maintain in proper working condition all portions of all facilities that are not included in the AMISP's scope of maintenance
  - mm) Provide all other necessary support as may be required time to time.
- 1.13** Dismantling of existing meter boxes and other scrapped service cables from site and Erection & Commissioning of service cable and meter boxes along with necessary items like CT'S, lugs etc. as per guidelines of the **MVVNL**. Agency shall carry out installation work of meter box, cable etc. with proper safety guidelines issued by the **MVVNL**/MVVNL for work at height, work on-live etc while also meeting all quality standards
- 1.14** All meter installations at user accessible height or consumer premises shall preferably be installed with Armoured service cable from LT line to Meter while at un-accessible height such as poles etc. may be installed with Un-Armoured Service Cable from LT Line to Meter. The service cable installation from Meter to Consumer premises shall be Un-Armoured in all case. The above may be reviewed on case-to-case basis with inputs from the **MVVNL**/MVVNL.
- 1.15** AMISP will be responsible to provide sufficient number of teams for installation activities as per work schedule targets to complete the work. Each Team should comprise of at least one technician along with a supervisor.
- 1.16** All the necessary civil work, due to dismantling the existing structure and to place new, shall be carried by the AMISP in a professional way.
- 1.17** In order to properly carry out analysis of delay in execution of contract/project, it is imperative that a date wise record of various activities right from award of contract to completion of works/supply is meticulously and systematically maintained by concerned departments in respect of areas under their responsibility. In line with the above, it shall be ensured by the concerned officer of the **MVVNL**, that the following details are maintained:
- a) Detailed Engineering Records: These shall include receipt of drawings/design calculations/other technical details from the contractor and its approval by the **MVVNL**, Type tests, Approval of Sub-contractor/vendor involving QR etc. and intermediate relevant activity.
  - b) Quality Assurance and Inspection records: These shall include approval of sub-contractor of Non-QR items, approval of Quality plan of Different manufacturers, Inspection of material including issuance of MICC based on Inspection call received from Contractor etc. (Responsibility: Quality Assurance Team of **MVVNL** and AMISP)
  - c) Site Execution Records: Execution site shall ensure that hindrance register is maintained, and entries are made therein on daily basis. The hindrance register should record all the hindrances in

scheduled progress of work, such as delay in release in fronts due to non-completion of work by another agency doing associated work, delay in supply of infrastructure, facilities by ‘Owner’ as per contract, delay in receipt of material, delay in deployment of trained/adequate manpower, nonavailability of site engineer/project in charge of contractor etc, apart from the day-to-day delay. These records also shall be reviewed during the fortnightly review of the progress of work by the concerned Officer, **MVVNL** and corrective measures shall be taken. Moreover, the entries/records in the register will be used/referred while analysing LD cases/arbitration cases/other claims of the contractor.

## 2. Supply, installation, integration, testing and commissioning of:

### 2.1 Smart Meters

The AMISP shall supply, install, integrate and commission smart meters of different types, the estimated number of which is given in the Bill of Material, in the Project Area throughout the Contract Period. The **MVVNL** shall provide details of new locations, consumer premises, Distribution transformers, feeders, boundary locations, etc. in the Project Area, where meters are to be installed from time to time.

Single phase whole current Smart Meters shall comply with technical specifications as provided in Annexure – A, three phase whole current Single Smart Meters shall comply with technical specifications as provided in Annexure – B, three phase LT-CT operated smart meters shall comply with technical specifications as provided in Annexure – C and three phase CT/PT operated smart meter shall comply with technical specifications as provided in Annexure – D.

In case additional meter specification/ requirements (over and above BIS standards), **MVVNL** shall provide the same in Annexure M of this section. *<This Annexure needs to be approved by the REC on ease-to-ease basis>*

The AMISP has to furnish valid BIS certification before the supply of meters.

After meter installation, details of consumer connections, such as consumer identification no., meter ID, its hardware & software configuration, name plate details, make, type i.e., 1 Phase or 3 Phase shall be updated in the system. The information would also be updated on the consumer portal and app for providing information to consumers.

- 2.2 Reference, the Smart Meter communication, it is envisaged that plug and play type communication modules shall be deployed in the smart meter, for any given communication technology. These modules shall be field-deployable, with corresponding communication interface modules being used in the DCU/Gateway or BTS of wide area network in accordance with the details provided in Annexure F. The General requirements for common pluggable module for smart meters as per Annexure F envisage a universal interface and a particular size irrespective of the choice of communication technology that defines the dimensions of the communication slot as well as physical placement and location of connectors. The same shall be adopted in all smart meters mandatorily for deployment w.e.f. 1 Jan 2023 or one year after BIS certification, whichever is later, and BIS certification taken accordingly as per IS 16444 for the same. The Network Interface Card (NIC) / Communication Module should be integrated with at least 3 (three) makes of meters in India to enable the respective meters to seamlessly integrate with proposed HES and/or MDM thus enabling interoperability of the system. In future, it would be AMISP’s responsibility to integrate new meter in consultation with **MVVNL** or facilitate integration of other application as per the approach paper submitted under the Project Implementation Plan.

### Communication Infrastructure

The communication infrastructure should either be based on RF / RF mesh network / PLCC /cellular network or a combination of these. Communication network shall provide reliable medium for two-way communication between various nodes (Smart Meter, Gateway/Router/Access Point/ DCU

(wherever applicable)) & HES. RF based network should use licensed / unlicensed frequency band as permitted by WPC. The engagement of network service provider would be in the scope of AMISP to meet the performance level as given in the document.

Meter data shall be routed / collected by field devices like Gateway/Router/Access Point, Data Concentrator Units (DCUs) wherever applicable given the communication technology used and transported to HES through WAN backhaul connectivity.

### 2.2.1 General Requirements

The AMISP shall design / hire reliable, interference free & robust communication network. It shall be effective for providing communication in terrain, topology & the consumer density of the project site.

During designing, suitable consideration shall be kept for future expansion as mentioned in Annexure-E. Before designing the communication network, the AMISP shall do the site survey and would provide the most efficient communication infrastructure.

The entire infrastructure & associated civil works required for installation & commissioning of equipment/devices such as DCUs, repeaters, routers & access points etc. shall be in the scope of AMISP.

The network Solution deployed by the AMISP should have disaster recovery mechanism in place. The redundancy mechanism of HES and MDM and their disaster recovery plan shall also be highlighted by the AMISP. AMISP shall satisfy itself through the operational testing of network as a whole and its element for reliability before starting operations and billing.

The quality of installation of the various equipment & power supply wiring to all field equipment shall be as per standards/ regulations/prevaling practices of the **MVVNL**. The reasonable supply of electricity needed for operation and maintenance of entire AMI system shall be provided by the **MVVNL** free of cost.

A suitable NMS shall be built to monitor the performance of the communication network round the clock. The NMS shall provide viewing of all the networking elements deployed at site and enable configuration & parameterization of the networking devices and the nodes. In case of public network such as cellular, the web-based portal (for example Open Network platform) should be provided to have the network view at location of installed devices. The portal shall have connectivity & subscription management.

A suitable digital platform (cloud-based application) and mobile apps could be provided to support field installation and capture field related activities and to manage the field operation & maintenance activity during the contract period. This platform shall manage project life cycle.

### 2.2.2 Network Management System (NMS)

The proposed NMS shall facilitate following activities:

- a) Security Management to protect systems and network from unauthorized access, manage user access, authorizing rights and privileges.
- b) Viewing of all network elements deployed in the field and administer configuration changes of the network devices and nodes through toolkits to automate the following tasks:
  - i. Capture running configuration, capture start-up configuration, upload configuration
  - ii. Compare configuration
  - iii. Real-time or scheduled capture of device configurations

- iv. Store historical device configurations captured and enable comparison of current device configuration against a previously captured configuration
- c) Security patch management of all applications shall be encrypted and signed.
- d) Performance Management to monitor network performance as specified.
- e) Fault Management to recognize, isolate, log and identify fault on network and connected nodes, devices.

The network management software shall be based on the latest secured version of SNMP v3. The NMS shall have a simple browser-based user interface to provide all the pertinent information about the system. The NMS shall not impact the availability and performance of AMI applications and shall load not more than 1% of network bandwidth and shall have secure communication.

The Network Management Software shall have following functionality:

- a) It shall maintain performance & error statistics, and present this information via displays, periodic reports and on-demand reports.
- b) Apart from real-time monitoring of critical network devices, the above information shall be collected and stored at user configurable periodicities i.e., 5 minutes to 60 minutes. The NMS shall be capable of storing the above data for a period of one (1) year at an interval of 5 minutes.
- c) It shall maintain a graphical display for connectivity and status of peripheral devices. The monitored devices shall be configured to send SNMP notifications, and the graphical element representing the device shall change to a different colour depending on the severity of the notification received.
- d) It shall issue alarms when error conditions occur.
- e) The period over which the statistics are gathered shall be adjustable by the user and the accumulated statistics shall be reset at the start of each period.
- f) The statistics shall be available for printout and display after each period and on demand during the period.
- g) In case more than one technology of AMI (example PLCC and RF between Smart Meter & DCU) deployed in the field. It shall maintain statistics on the performance and availability of node being delivered per AMI technology.

#### **2.2.2.1 NMS Requirements Specific to HES**

The Network Management System (NMS) function within the HES shall manage communication network and its associated devices and monitor the performance of network. This module shall provide real time information about the IP network and its associated NAN/WAN modules in the field device/s.

- a) NMS shall be able to collect parameters viz. terminal status, device status, next hop information, RF / PLC signal strength, Hardware/software version numbers, communication logs/events etc. For cellular WAN network, it shall be able to constantly monitor the meter WAN module for its connectivity and signal strength and quality
- b) NMS function shall be able to perform ping & trace-route to an individual and a group of Nodes (NAN / WAN), Routers /Gateways / Access Point, DCU.
- c) NMS function shall routinely check the logged in status of the end node / field device and its availability in the network for data exchange. In case of failure to get the 'alive'

message from the end node/field device, it shall mark and notify the node as logged out. It shall be also possible to restart of a node (NAN/WAN) as well as trigger a hardware reset of the node.

- d) NMS function should be able to collect and store monitoring profiles from End Points (NAN/WAN modules) and network devices for performance evaluation and troubleshooting purposes. Historical logs of monitored profiles shall be available analysis through standard reporting tool.
- e) If GIS is enabled, then topology, location (lat./long) and status of all network nodes shall be visible on GIS map.

### 2.2.3 Network Protection & Security

The AMI Network shall have adequate cyber security measures not limited to the measures as described below. The network security would be extended to all the interfaces also.

**Secure Access Controls:** The system shall include mechanisms for defining and controlling user access to the applications environment. Best practices from enterprise security including password strength, password aging, password history, reuse prevention etc. must be followed for access control.

**Authorization Controls:** A least-privilege concept such that users are only allowed to use or access functions for which they have been given authorization shall be available.

**Logging:** Logs must be maintained for all attempts to log on (both successful and unsuccessful), any privilege change requests (both successful and unsuccessful), user actions affecting security (such as password changes), attempts to perform actions not authorized by the authorization controls, all configuration changes etc. Additionally, the access to such logs must be controlled in accordance with the least-privilege concept mentioned above, so that entries may not be deleted, accidentally or maliciously.

The overall cyber security policy and implementation shall account for:

- a) Prevent unauthorized users from reading or writing data or files, executing programs or performing operations without appropriate privileges.
- b) Document all user sign on procedure
- c) Record all network traffic for detecting unauthorized activity, unusual activity and attempts to defeat system security (AMISP to propose and document what constitutes normal activity/traffic)
- d) A user authentication scheme consisting of at least a user identification and password shall be required for the user to request a connection to any network node.
- e) GUI to provide role-based access based on user identity and user role. Shall have following types of users:
  - i. Administrator
  - ii. Operator
  - iii. Field staff
  - iv. Viewer/Guest

## 2.2.4 Communication Network Elements

Following sections provide detail on both DCU based communication network and router-based RF mesh network. The AMISP shall select relevant parts as applicable for designing and establishing communication infrastructure. The network shall be horizontally and vertically scalable to accommodate future meter installations. <M V V N L to define the scalability level required for the network>. The network elements may be comprised of the following.

### 2.2.4.1 Data Concentrator Unit (DCU) based Communication Network (<to be kept as redundant item if required, otherwise the entire section is to be deleted>)

The Data Concentrator Unit is a gateway for communication of data between the Smart Meters and the HES. The Data Concentrator Unit receives information from the Smart Meter on a scheduled / need basis and passes it on to HES / MDM.

The DCU provides the central link between Smart Meters and HES, enabling continuous/periodic meter-read and control. DCU shall exchange data from Smart Meters on RF / PLCC communication and with HES on WAN.

#### 2.2.4.1.1 Hardware & Power Supply of DCU

- a) Enclosure/box of DCU shall be IP65 or better compliant. A suitable mounting arrangement required for DCU installation shall also be provided.
- b) A suitable and optimum power supply shall be provided keeping in view that even in case of outage in one or two phases, DCU can be powered. DCU should be capable of withstanding surges & voltage spikes of 6 kV. Power supply shall be terminated on suitable sized Miniature Circuit Breaker (MCB) to facilitate isolation during on-site maintenance.
- c) DCU shall have battery with backup for 1(one) hour for normal meter reading, to push tamper event, carry out on demand reading and the network health status/ connectivity continuity & check. DCU should have the suitable feature to send power outage and restoration message to the HES.
- d) DCU shall have built-in Real Time Clock (RTC) with separate battery backup. It shall have self- diagnostic feature for RTC, memory, battery, communication module, etc.

#### 2.2.4.1.2 Configuration, Functionality & Interface of DCU

DCU shall have following configuration functionalities / tools:

- a) Configuring the communication with underlying nodes/meters.
- b) Communication of data from the field devices and push the data at configured intervals to the HES. It should also support the HES in pulling data from the field devices/meters. The data acquisition (Push/Pull) frequency shall be configurable. DCU shall be capable to prioritize control commands.
- c) DCU shall ensure a secure communication to HES and shall have internal memory for storing interval data for at least 5 (five) days. This storage shall be in non-volatile memory as opposed to battery backed memory.
- d) DCU shall support on demand read and ping of individual/group of meters.
- e) It shall support IPv6 network addressing.

- f) DCU shall push events such as tamper, power off etc. to HES immediately on occurrence/receipt from field devices/meters.
- g) The equipment shall be weatherproof, dustproof and constructed for outdoor installation on poles (minimum rating: IP65). A suitable mounting provision shall be made for the equipment.
- h) Enclosure: Provision for security sealing shall be provided and in case the gasket of the cover is used for protection against moisture, dust and insects, the gasket shall be made of weather and aging resistant material.
- i) The list of standards followed in all the devices/equipment used in communication network shall be furnished
- j) The communication network shall have dynamic & self-healing capability. If one of the communication elements fails, then nodes connecting to that element shall switch to best available element for communication of data to HES.

#### **2.2.4.1.3 DCU Communication**

- a) The DCU shall ensure the appropriate backhaul for secure transfer of data to HES either via cellular or Fiber Optic communication. In case of cellular backhaul, it shall support SIM card / e-SIM with dynamic/static IP as the architecture demands from any service provider. It shall have Wide Area Network (WAN) connectivity to the HES through suitable means. Best available link shall be used to connect to HES.
- b) DCU shall be able to communicate with meters through a secured, standard communication protocol between meter and DCU.
- c) DCU shall periodically monitor meter reads/downstream commands and shall retry and reconnect in case of failed events/reads.
- d) It shall push events such as tamper, power off etc. to HES immediately on occurrence/receipt from field devices/meters. DCU shall be able to acquire and send data to HES for full capacity (as per designed for no. of meters/field devices) to ensure the performance level. Full capacity of DCU is required to be indicated in the offer.
- e) On restoration of power supply, DCU shall establish communication with underlying devices as well as upstream application automatically.
- f) DCU shall be able to communicate with the nearest meters.
- g) Remote firmware upgrade: The DCU shall support remote firmware upgrades as well as remote configuration from the Network Operation cum Monitoring Centre (NOMC)
- h) DCU shall facilitate recording of minimum of the following events at HES (for 7 days):
  - i. No of packet failures
  - ii. Retry attempts
  - iii. Missed periodic readings
  - iv. Failure to connect
  - v. Tamper events

#### **2.2.4.2 Gateway/ Router/ Access Point based RF Mesh Network**

In this type of communication network, different network nodes including end points (Smart Meters) shall interconnect with each other using RF mesh network and they shall communicate with nearby gateways/ routers to transfer the data to access points. If any gateways/ routers/ repeaters/ access points fail, then nodes connected on that device shall automatically reconfigure the mesh with available nearby nodes.

##### **2.2.4.2.1 General Requirement of RF Mesh Network:**

- a) The communication network shall have dynamic & self-healing capability. If one of the communication elements such as gateways/ routers/ access points fails, then nodes connecting to that element shall switch to best available element for communication of data to HES.
- b) It shall support IPv6 network addressing.
- c) Each node shall keep a track of best available nearby nodes or access points.
- d) The communication network equipment shall use Unlicensed or Licensed frequency band as permitted by WPC/Statutory Bodies as applicable.
- e) All the communication network equipment shall be as per WPC guidelines, Government of India for operation in licensed / license free frequency band.
- f) Suitable NMS shall be available to monitor the performance of the communication network round the clock. The NMS shall provide viewing of all the networking elements deployed at site and enable configuration, parameterization of the networking devices and the nodes.
- g) It shall support remote firmware upgrading
- h) It shall be secure enough to avoid all cyber threats
- i) The communication network shall ensure secure communication of data to HES.
- j) The equipment shall be weatherproof, dustproof and constructed for outdoor installation on poles (minimum rating: IP65). A suitable mounting provision shall be made for the equipment.
- k) The list of standards followed in all the devices/equipment used in communication network shall be furnished.
- l) Gateway/ Router/ Access Point shall have battery with backup for 1(one) hour for normal meter reading, to push tamper event, carry out on demand reading and the network health status/ connectivity continuity & check etc. during battery operations also. It should have the suitable feature to send power outage and restoration message to the HES even during battery back-up.

##### **2.2.4.2.2 Configuration, Functionality & Interface**

Access points shall have following configuration functionalities:

- a) It shall be able to configure the communication with underlying nodes/end points.
- b) It shall support on demand read and ping of individual/group of meters.



- c) It shall push events such as tamper, power off etc. to HES immediately on occurrence/receipt from field devices/meters.
- d) It shall have Wide Area Network (WAN) connectivity to the HES through suitable means.
- e) It shall communicate with gateways/ routers/ nodes/ end points/ access points on RF mesh network (Unlicensed or Licensed frequency band as permitted by WPC/Statutory Bodies in country of deployment as applicable).
- f) It shall periodically monitor meter reads/downstream commands and shall retry and reconnect in case of failed events/reads.
- g) After power Interruption, on restoration of power supply, it shall establish communication with underlying devices as well as upstream application (HES) automatically.
- h) Access point shall facilitate recording of minimum of the following events at HES (for seven (7) days):
  - i. No of lost packets
  - ii. Retry attempts
  - iii. Missed periodic reading
  - iv. Failure to connect
  - v. Tamper events
- i) It shall be capable to handle interval data of suitable nos. of any type of Smart Meter. Access point shall be able to acquire and send data to HES for full capacity (No. of meters/field devices it is designed for) within a suitable time period to achieve the performance level. Full capacity of access point is required to be indicated in the offer.
- j) Gateway / Router / Access point shall support remote firmware upgrades as well as remote configuration from the Network Operation cum Monitoring Centre.
- k) The Gateway / Router / Access Points shall have provision to maintain the time and date information and shall always be in Time synchronization to the HES server via NTP to sub second accuracy. The Gateway / Router / Access Points shall support time distribution to each Mesh Node.

### 2.3 Head End System (HES)

The main objective of HES is to acquire meter data automatically avoiding any human intervention and monitor parameters acquired from meters.

The AMISP shall provide a HES which is suitable to support the collection and storage of data as per performance level for a defined no. of Smart Meters with facility of future expansion as per the requirement specified in this document.

*<NOTE: The no of Smart Meters/future expansion may be provided by **MVVNL** as per their requirement>*

HES shall be responsible for discovery of all Smart Meters once deployed in the field, the periodic collection of all meter data as well as the processing of all alarms and commands such as connect/disconnect for those meters.

HES would perform all the requisite functions as per the defined functionalities of AMI and it is the responsibility of the AMISP to supply the requisite software and hardware to achieve the defined

functionalities of AMI. HES shall ensure data integrity checks, for example, checksum, time check, pulse, overflow, etc. on all metered data.

HES shall be developed on open platform based on distributed architecture for scalability without degradation of the performance using additional hardware. The scalability shall ensure the ability to handle applicable workloads including the following: <MVVNL to define the scalability required. An indicative list of parameters is provided below>

- a) Up to [x] numbers of meters installed
- b) [5/15] mins interval meter reads
- c) [y] users requesting data from meters
- d) Other events and statuses coming from meters.

The HES shall be cloud enabled and support deployment with high availability clustering and automatic load balancing that ensure hardware as well as application failover. Adequate data base and security features for storage of data at HES need to be ensured.

The suggested functions of HES (not exhaustive) may be:

- a) On power up after installation, Smart Meter shall register itself automatically into the HES along with its metering profile. The HES shall store meter profile status by meter type, hardware & software versions, device IDs, logged in / logged out details etc.
- b) Upon deployment and establishment of communication, it shall be possible for field level end device nodes (NAN/WAN) like Router/Gateway, Access Point, DCU to have self-discovery and registration.
- c) Acquisition of meter data on demand & at user selectable periodicity. On demand meter read may be for single meter (unicast) or for a group of meters (multicast).
- d) Two-way communication with meter/ DCU
- e) Signals for connect & disconnect of switches present in end points such as meters. This facility shall be provided for both single meter (unicast) as well as for a group of meters (multicast).
- f) Audit trail and Event & Alarm Logging
- g) Ability to redirect messages including configuration commands from the MDM in order to reach the desired meter
- h) Maintain time sync with DCU / meter
- i) Store raw data for defined duration (minimum 3 days). HES shall hold the data before it is transferred to the MDM
- j) Handling of Control signals / event messages on priority
- k) Manage time distribution to ensure that nodes / meters always have an accurate RTC using NTP servers. The time distribution mechanism shall take into account the network latencies.
- l) Setting of Smart Meter configurable parameters
- m) Critical and non-critical event reporting functionality
- n) Device management functionality to get periodic updates from devices on health check, hardware & firmware version, location mapping etc.
- o) The data collection and computation for the purpose of SLA penalties (as mentioned in the following table) should be automated and visualized in MVVNL Interface as per Clause 2.5 of this Section.

### 2.3.1 Configuration

HES shall facilitate configuration of following minimum AMI parameters:

- a) Load profile capture period
- b) Demand integration period
- c) Setting of parameters for TOU billing

- d) Prepaid / post-paid configuration
- e) Net metering
- f) Billing date / month-to-date for prepaid meters
- g) Clock setting/time synchronizations
- h) Load curtailment limit
- i) Event setting for connect/disconnect
- j) Number of auto reconnection attempt
- k) Time interval between auto reconnection attempts
- l) Lock out period for endpoint (meter) relay
- m) Remote firmware update: It shall be possible to update the firmware of the meters in both Unicast (one to one) and in Multicast fashion (Group of meters). It shall be also possible to have remote firmware upgrade for an individual and a group of nodes (NAN/WAN, Routers/Gateways/Access Point, DCU).
- n) Password setting
- o) Push schedule
- p) Setting threshold limits for monitored parameters

The AMISP may suggest more parameters as per the requirement.

### 2.3.2 Communication

The following communication functions with network devices shall be supported:

- a) HES shall communicate with DCUs/access points using WAN technology
- b) HES shall encrypt data for secure communication
- c) HES shall be able to accept data according to IS 15959 part-2 /part 3 and latest amendments
- d) HES shall automatically retry for missed data; the number of retry attempts shall be configurable
- e) To receive confirmation on successful execution of a command
- f) HES shall ensure data integrity checks, for example, checksum, time check, pulse, overflow, etc. on all metered data

### 2.3.3 Monitoring and Reporting Capability

HES shall have critical and non-critical reporting functionality. The critical & non-critical information generated from this reporting functionality shall be made available to MDM at user configurable periodicity.

#### 2.3.3.1 Critical Reporting

HES shall have alarms and keep record of following events:

- a) Event log for node's (meter) events such as tamper/power failures etc.
- b) Data not received from nodes/end points
- c) Relay does not operate for connect / disconnect

- d) Communication link failure with nodes/end points
- e) Network Failure
- f) Power Failure

### 2.3.3.2 Non-Critical Reporting

HES shall report and keep record of following communication failure events:

- a) Retry attempts
- b) Missed periodic reading
- c) Failure to connect

HES shall support reporting of communication failure history of nodes/routers/access points etc. and give an exception report for nodes/routers/access points not communicating for last 0 – 24 hours (the reporting period shall be on user configurable period). HES shall have feature to send email/SMS notification of configured alarms & events to its users.

## 2.4 Meter Data Management system (MDM)

The Meter Data Management system (MDM) shall support storage, archiving, retrieval & analysis of meter data and various other MIS along with validation & verification algorithms. The MDM shall be a scalable and COTS product. It shall act as a central data repository with interactive dashboard. MDM shall have capability to import raw or validated data in defined formats and export the processed and validated data to various other systems sources and services in the agreed format. It shall provide validated data for upstream systems such as billing, analytics, reporting, etc.

As mentioned in Clause 1.2 (g) of this Schedule, MDM should support the future requirement of **MVVNL** by way integration with other smart grid functionalities as listed in Clause 1.2 (g) as and when implemented by **MVVNL**. In this effort, the methodology as outlined in the approach paper shall be followed.

The key use cases to be enabled by AMISP are provided below. Please note that these are illustrative list of use cases only and is not an exhaustive list. Further please note that all IS Standards shall be applicable.

Sr.	Use Case Activity Description	Source	Destination	Info Exchanged
1.	<b>Collection of Daily Meter Profile</b>			
1.1	At scheduled frequency HES should pull the Daily Meter Data from Smart Meter over communication Channel	HES	Meter	Meter Number, reading date & time, kW, kVA, kWh, kVAh, PF, Non-critical Event Code / Date
1.2	Meter should send the data to HES. Provision for retrial should be there if Meter data is not collected within time. Consumption details including non-critical events will be in 15 min/30 min block data, and data could be incremental to what was sent by meter	Meter	HES	Meter Number, reading date & time, kW, kVA, kWh, kVAh, PF, Non-critical Event Code / Date

Sr.	Use Case Activity Description	Source	Destination	Info Exchanged
	in preceding instance			
1.3	HES should send the data to MDM	HES	MDM	Meter Number, reading date & time, kW, kVA, kWh, kVAh, PF
1.4	MDM should send the required parameter to Prepaid system for daily charge calculation at least once on daily basis	MDM	Prepaid Engine	Meter Number, reading date & time, kW, kVA, kWh, kVAh, PF, Non-critical Event Code / Date
<b>2.</b>	<b>Monthly Billing profile collection</b>			
2.1	Command from Billing system triggered and send to MDM / HES for collection of Monthly billing Data	Billing System	MDM / HES	Meter Number, reading date & time, kW, kVA, kWh, kVAh, PF, Non-critical Event Code / Date
2.2	At scheduled frequency HES should pull the monthly meter data from Smart Meter over the communication channel	HES	Meter	Meter Number, reading date & time, kW, kVA, kWh, kVAh, PF, Non-critical Event Code / Date
2.3	Meter should send the data to HES. Provision for retrial should be there if Meter data is not collected within time.	Meter	HES	Meter Number, reading date & time, kW, kVA, kWh, kVAh, PF, Non-critical Event Code / Date
2.4	HES should decrypt and validate the data collected and send to MDM	HES	MDM	Meter Number, reading date & time, kW, kVA, kWh, kVAh, PF, Non-critical Event Code / Date
2.5	MDM should send the required parameter to Billing system for Monthly Bill calculation	MDM	Billing Engine	Meter Number, reading date & time, kW, kVA, kWh, kVAh, PF, Non-critical Event Code / Date
<b>3.</b>	<b>Remote Meter disconnection</b>			
3.1	Meter disconnect operation command after wallet balance calculation	Prepaid Engine/ Billing system	MDM	Meter Number, group of meters, instruction to close switch
3.2	Disconnection alert sent to consumer	MDM	Billing System	Meter Number, group of meters, instruction to close switch
3.3	Meter disconnection operator command	MDM	HES	Meter number, action (disconnect)

Sr.	Use Case Activity Description	Source	Destination	Info Exchanged
3.4	Consumer meter disconnection	HES	Meter	Meter Number, switch status
3.5	Disconnection Status Update	Meter	HES	Meter Number, switch status
3.6	Disconnection Status Update	HES	MDM	Meter Number, switch status
4.	<b>Remote Meter Reconnection</b>			
4.1	Meter reconnect operation command after wallet recharge Billing	Billing system/ Prepaid Engine	MDM	Meter Number, group of meters, instruction to close switch
4.2	Meter reconnect operation command	MDM	HES	Meter Number, group of meters, instruction to close switch
4.3	Consumer meter reconnection	HES	Meter	Meter number, action (reconnect)
4.4	Reconnection Status Update	Meter	HES	Meter number, action (reconnect)
4.5	Reconnection Status Update	HES	MDM	Meter number, action (reconnect)
5.	<b>MVVNL detects tampering at consumer site</b>			
5.1	High priority events captured by Meter sent to HES as and when occurred	Meter	HES	Meter Number, event date & time, event Code /description
5.2	High priority events reach MDM for further action.	HES	MDM	Meter Number, event date & time, event Code /description
5.3	Share with WFM to Notify MVVNL personnel for site inspection	MDM	WFM	Consumer number, Meter Number, Tamper code, address
5.4	On analysis and detection of valid tamper event or malfunction, the tamper event must be sent / pushed by the meter to the HES /MDM	Meter	HES/ MDM	Consumer number, meter number, action to be triggered (disconnect), action date & time
5.5	HES sends disconnect command to meter	HES	Meter	Meter Number, action (disconnect)
5.6	Tamper event shared with CIS/CRM. Billing determinants are updated for tamper invoicing	MDM	CIS / CRM	Meter Number, event date & time, event Code /description
5.7	Meter re-connection order once tamper issue is resolved	MDM	HES	Meter number, action (re-connect)

Sr.	Use Case Activity Description	Source	Destination	Info Exchanged
5.8	HES sends re-connect command to meter	HES	Meter	Meter Number, action (re-connect)
6.	<b>Missed interval readings</b>			
6.1	On identifying missed interval, HES will re-acquire data for the missing period from meter	HES	Meter	Meter Number, from date & time, to date & time (for which data is missing)
6.2	On receiving data request command, meter will send data to HES	Meter	HES	Meter Number, reading date & time, kW, kVA, kWh, kVAh
6.3	Missed Interval and Reads Data acquired by MDM	HES	MDM	Meter Number, readings with date & time
7.	<b>Consumer connection outage/restoration event</b>			
7.1	Outage/restore event recorded by meter is sent to HES as and when event occurs	Meter	HES	Meter Number, Outage / restoration Date / Time, Power On or Off count
7.2	Outage / Restoration Notification	HES	MDM	Meter Number, Outage / restoration Date / Time, Power On or Off count
7.3	Sharing Outage / Restoration Notification	MDM	OMS/CIS-CRM	Meter Number, Outage / restoration Date / Time, Power On or Off count
7.4	Meter read request from OMS to identify service outage / restoration	OMS	MDM → HES	Meter Number,
7.5	Meter responds to event poll from HES	Meter	HES	Meter number, Status (live/dead)
8.	<b>Remote firmware upgrades/ meter configuration changes</b>			
8.1	Remote firmware upgrade	HES	Meter	Firmware
8.2	Configuration Commands: Change tariff parameters, Synchronize clock, Registers reset (status, max, tampering)	HES	Meter	Meter number, tariff parameters, registers status, event type and priority
8.3	Status update of Firmware / Configuration	Meter	HES	
9.	<b>Load monitoring at demand side</b>			
9.1	When there is a load violation event recorded in the meter, the information	Meter	HES → MDM	Meter Number, max demand, date & time of

Sr.	Use Case Activity Description	Source	Destination	Info Exchanged
	is sent to the CC			load violation
10.	<b>Time synchronization</b>			
10.1	Synchronizing RTCs of meters / DCUs/ACP	HES	DCU/Meter	Time Setting
11.	<b>Metering network changes</b>			
11.1	Change / new installation in Meter / DCU Network Hierarchy	Meter / DCU	HES	Network identification info including DCUs
11.2	Change / new installation in Meter / DCU Network Hierarchy	HES	MDM	Network identification info including DCU
12.	<b>New consumer connection</b>			
12.1	Receive verified pre & post-paid new consumer requests	CIS-CRM/ Billing	MDM	Consumer name, address. Connection request etc.
12.2	Generate meter installation order	MDM	/WFM	Consumer ID & details
12.3	Receive meter installation report	WFM	MDM	Meter number, DT no, Feeder & reading
12.4	Requesting instant, interval & events data from meters	MDM	HES → Meter	Meter Number, Reading date & time, reading params (kWh, kVAh, kW etc.)
12.5	Acquire instant, interval / events data from meter by HES which then reaches MDM system.	HES	MDM	Meter Number, Reading date & time, reading params (kWh, kVAh, kW etc.)
12.6	Once new meter remote read verification is over, confirm new connection with other applications	MDM	Billing / CIS-CRM	Consumer ID, Consumer address, Meter Number, initial reading etc.
13.	<b>Migrate post-paid consumer to prepaid mode</b>			
13.1	Receive migration request	CIS-CRM/ Billing	MDM	Migration request for post-paid consumer with profile
13.2	Setup prepaid consumer profile in prepaid engine. If no change in meter is required, skip next two steps	MDM	Prepaid Engine	Prepaid consumer profile
13.3	Generate prepaid meter installation order if required	MDM	WFM	Consumer ID & details
13.4	Receive meter installation report	WFM	MDM	Meter number, DT no, Feeder & reading



Sr.	Use Case Activity Description	Source	Destination	Info Exchanged
13.5	Enable prepaid mode in meter	Prepaid engine	HES → Meter	Engineering token
13.6	Receive activation confirmation	HES	MDM	Activation status
13.7	Request instant, interval & events data from meter	MDM	HES → Meter	Meter Number, Reading date & time, reading params (kWh, kVAh, kW etc.)
13.8	Acquire instant, interval / events data from meter by HES which then reaches MDM system.	HES	MDM	Meter Number, Reading date & time, reading params (kWh, kVAh, kW etc.)
13.9	Once meter remote read verification is over, share migration request completion detail with other modules	MDM	Billing / CIS-CRM	Prepaid consumer profile
14.	<b>Migrate prepaid consumer to post-paid mode</b>			
14.1	Receive migration request	CIS-CRM	MDM	Migration request for prepaid consumer with profile
14.2	Request meter data	MDM	HES → Meter	Meter Number, Consumer ID
14.3	Acquire instant, interval / events data from meter by HES which then reaches MDM system.	HES	MDM	Meter Number, Reading date & time, reading params (kWh, kVAh, kW etc.) with balance credit
14.4	Send meter disconnect command	MDM	HES → Meter	
14.5	Receive connection status	HES	MDM	Disconnect status
14.6	Enable post-paid mode in meter	MDM	HES → Meter	Engineering token
14.7	Receive activation of post-paid mode	HES	MDM	Activation Status
14.8	Request instant, interval & events data from meter	MDM	HES → Meter	Meter Number, Consumer ID
14.9	Acquire instant, interval / events data from meter by HES which then reaches MDM system.	HES	MDM	Meter Number, Reading date & time, reading params (kWh, kVAh, kW etc.)
14.10	Once meter remote read verification is over, share migration request	MDM	Billing / CIS-CRM	Post-paid consumer profile and meter data

Sr.	Use Case Activity Description	Source	Destination	Info Exchanged
	completion detail with other modules			along with credit balance
15.	<b>Consumer Registration in Consumer Portal/ App</b>			
15.1	Consumer clicks on new user on consumer portal/ App, provides RMN or email ID and submits data	Portal/ App	CIS/CRM	Request for registration with RMN/email ID
15.2	MVVNL receives request for registration and sends OTP after verification	CIS/CRM	Email/Messag e Gateway	OTP
15.3	Consumer submits OTP	Portal/ App	CIS/CRM	
15.4	Consumer receives registration detail	CIS/CRM	Email Gateway	Login ID and default password
15.5	Consumer submits first login request	Portal/ App	CIS/CRM	
15.6	System seeks password change	CIS/CRM	Portal/ App	
15.7	Consumer changes default password	Portal/ App	CIS/CRM	
16.	<b>Consumer Access to Consumption, Billing &amp; Profile Data</b>			
16.1	Consumer logs in to Portal/ App	Portal/ App	MDM	
16.2	Consumer Profile for Portal/ App	CIS-CRM	MDM →Portal/ App	Name, Account, Address, Service Points, K Number
16.3	Consumption Data	MDM	Portal/ App →UI	Consumption profile
16.4	Billing (post-paid) / Credit Balance (prepaid)	Billing → MDM	Portal/ App	Post-paid Billing history/ Current Bill, Prepaid Recharge history
17.	<b>Prepaid Consumer Recharge</b>			
17.1	Consumer logs into Portal / Mobile App	Mob App / Portal	UI	Login
17.2	Consumer fills-in required detail in UI and requests recharge	UI→ Prepaid App	Payment Gateway	Consumer ID, Recharge amount
17.3	Consumer selects payment method	Payment Gateway	Net banking /Credit Card / Wallet etc.	
17.4	Consumer receives	Payment	Prepaid	

Sr.	Use Case Activity Description	Source	Destination	Info Exchanged
	payment acknowledgement	Gateway	App→Portal →UI	
17.5	Calculate credit balance for prepaid consumer & update prepaid meter	Prepaid App	HES→Meter	Consumer credit balance (virtual token)
17.6	Notify credit balance to consumer	Prepaid App	Email/SMS Gateway	Credit Balance
18.	<b>Post-Paid Consumer Bill Payment</b>			
18.1	Consumer logs into Portal / Mobile App	Mob App / Portal	UI	Login
18.2	Consumer is presented with Billing history and current outstanding Bill	Billing → MDM	Portal/ App→UI	Outstanding Bill
18.3	Consumer requests bill payment. Option to download bill	UI→Billing	Payment Gateway	
18.4	Consumer selects payment method	Payment Gateway	Net banking /Credit Card / Wallet etc.	
18.5	Consumer receives payment acknowledgement	Payment Gateway	Billing→ Portal/ App→UI	
18.6	Payment acknowledgement through email/SMS	Billing	Email/SMS Gateway	Payment acknowledgement
19.	<b>Consumer Service Request</b>			
19.1	Consumer logs in to Portal/ App	Portal/ App	CIS/CRM	
19.2	Consumer requests for service	UI	CIS/CRM	Service request
19.3	System assigns SRN & sends acknowledgement	CIS/CRM	Portal/ App→UI, Email/SMS Gateway	
19.4	System resolves request & updates consumer records	CIS/CRM	Portal/ App→UI, CIS/CRM	
19.5	System closes SRN	CIS/CRM	Email/SMS Gateway	
20.	<b>Consumer Complaints</b>			
20.1	Consumer logs into Portal/ App	Portal/ App	CIS/CRM	
20.2	Consumer registers complaint	UI	CIS/CRM	Specific complaint
20.3	System assigns CRN &	CIS/CRM	Portal/	

Sr.	Use Case Activity Description	Source	Destination	Info Exchanged
	sends acknowledgement		App→UI, Email/SMS Gateway	
20.4	System assigns resolution based on nature of complaint	CIS/CRM	CIS / OMS / WFM	
20.5	Target system reports completion of complaint	OMS / WFM	CIS/CRM	
20.6	System updates records and closes CRN	CIS/CRM	CIS, Email/SMS Gateway	
21.	<b>Demand read of meters from consumer premises</b>			
21.1	Requesting instantaneous, interval, load profile & events data from meters	MDM	HES→Meter	Meter Number, Reading date & time, reading params (kWh, kVAh, kW etc.)
21.2	Acquire instant, interval, load profile & events data from meters by HES which then reaches MDM system.	Meter→ HES	MDM	Meter Number, Reading date & time, reading params (kWh, kVAh, kW etc.)
22.	<b>Staff User Access to <span style="background-color: yellow;">MVVNL</span> Portal</b>			
22.1	User logs in to Portal	Portal	MDM	Login with appropriate credentials
22.2	User selects available functions	MDM	Portal → UI	
22.3	User logs out	Portal → UI	MDM	

The AMISP shall specify and deliver an initial system that supports the collection and storage of data for meeting the performance level for [X no of consumers/ Smart Meters] with facility of future expansion.

The MDM shall have the ability to selectively choose which data to be maintained and which to be purged or archived [as per requirement of MVVNL (user selectable)]

#### 2.4.1 Asset Management

- a) The MDM shall maintain information and relationships between the current installed meter location (apartment, shop, industry/ address etc.), Consumer information (Name etc.), Consumer account no, Meter ID, Type of Meter (type of consumer, 1 phase/ 3phase, with or without relay, etc.), Meter configuration (Demand integration period, Load profile capture period etc.), GIS supplied information (longitude, latitude, connection with feeder/ transformer/ pole etc.) etc.
- b) The software should support tracking the status of meters and communication equipment from the date when they are installed in the field. The history of in-service asset location is maintained throughout the device life with start and end dates associated with each in-service location reference.

- c) Ability to report and log any damage / deterioration in the meter attributable to consumer /MVVNL.

#### 2.4.2 AMI Installation Support

- a) The MDM shall also support device lifecycle management from device registration, installation, provisioning, operations and maintenance to decommissioning etc. The MDM shall generate exceptions for meter or modules not delivering the correct meter data after installation.
- b) The MDM shall provide a reconciliation report that identifies the meters that have been installed but not communicating for a designated (configurable) period. MDM shall generate reports on the number of meters installed in comparison to the number of meters successfully communicating.

#### 2.4.3 Meter Data

- a) The MDM shall accept input, process, store, and analyse Meter data from HES and meter data collected through handheld meter reading instruments and manual meter reads. In case of manual reads, provision should be there to insert associated notes such as assessed energy, etc. It would responsibility of AMISP for manual meter reading in case of any communication failure, etc. with seven (7) days of such failure.
- b) The MDM should accept input, process, store, and analyse non-billing meter data such voltage and power quality data (such as under/over voltage, out of band frequency, etc.) as they are available from HES. The MDM should also support schedule and on-demand meter reads and pinging of meter energized states by authorized users and by other MVVNL/MVVNL systems.
- c) The MDM shall provide storage and retrieval of all collected Meter Data, events and alarm. It shall have capacity of storing [X] years data (as required by the MVVNL based on regulatory provisions) via archiving
- d) The archiving of data should be done at a frequency of [x] and all data older than [x] days/hours should be archived. AMISP's solution should describe the process of archiving and restoration from the archive.
- e) Correctly track & resolve energy usage across meter changes with no loss of individual meter data.
- f) Provide complete history and audit trail for all data collected from meters including commands sent to meters and other devices for 30 days (configurable period).
- g) Execute on-demand read processes.
- h) Handle special metering configurations such as net metering/pre-paid metering/multiple meters at same premises.
- i) The MDM shall have the ability to manage at a minimum 5-minute interval data.
- j) The AMISP shall ensure data integrity checks on all metered data received from data collection systems.

#### 2.4.4 Data Validation, Estimation, and Editing (VEE)

- a) The validation and estimation of metered data shall be based on standard estimation methods (such as max/avg. of past three days, max/avg. of past X number of similar weekdays,

---

max/avg. of similar blocks of past X numbers of similar weekdays, etc.). The MDM should also support and maintain following data-

- i. Registered Read Data including register reads, daily billing cycle, as well as derived billing determinants such as TOU
  - ii. Interval Data channels with variable intervals and variable units of measure
  - iii. Calculated Data that is derived or computed such as billing determinants and aggregated loads.
  - iv. Event data storage of all collected event and alarm data from meters, network equipment, and MDM itself
- b) MDM shall flag, alarm and trigger an estimating process including but not limited to when the following anomalies occur in the cumulative (“CUM”) register reads
- i. CUM decrements within a billing cycle (except net-metering)
  - ii. CUM reads increments more than configurable threshold
  - iii. Future or old read dates
  - iv. Number of digits exceeds number of meter dials
- c) MDM shall detect, flag, alarm and trigger an estimating process including but not limited to when the following anomalies occur in Time of Use (TOU) register reads
- i. Register decrements (except net-metering)
  - ii. Resets (to zero) (except net-metering)
  - iii. CUM reads increments more than configurable threshold
  - iv. Future or old read dates
  - v. Erratic compared to CUM read (sum of TOU reads minus CUM read)
- d) MDM shall detect, flag, alarm and trigger an estimating process including but not limited to when the following anomalies occur in Demand register reads
- i. Do not reset on cycle
  - ii. Do not reset coincident with consumer move-out or move-in
  - iii. Reset off cycle inappropriately
  - iv. Too high
- e) All data shall be transferred to billing system after meter data validation and estimation including transformer / feeder station wise energy audit.
- f) MDM shall estimate usage for non-metered service points such as streetlights, farm lights, traffic signals, etc.
- g) The MDM shall maintain both the original received raw data in a non- manipulated state, in addition to VEE data.
- h) Notwithstanding the latency of data collection via the AMI system, once the MDM receives meter read data, the VEE process occurs in real-time and the post-VEE data is then immediately available to user or external systems.

- i) The MDM shall be able to automatically flag data changes from manual edits, VEE (Validating, Editing and Estimating) rules and data source corrections and electronically generate audit trail with timestamps and user-ids.

#### 2.4.5 Billing Determinants Calculations

The MDM-

- a) Shall allow configuring multiple TOU options (e.g., the number and duration of TOU rate periods) by consumer type, tariffs and day type (weekend, weekdays, and holidays) and by season.
- b) Shall support the processing of interval data into billing determinants to include the following at a minimum:
  - i. Total Consumption
  - ii. Consumption in different time blocks for ToU billing
  - iii. Maximum Demand (in kW and kVA)
  - iv. Number of tamper counts
  - v. Average power factor
  - vi. Net-Metering data
- c) Shall process interval data and frame it into the appropriate TOU periods for consumption and demand; for example, roll up 15/30-minute data intervals into hourly data.
- d) Shall have the ability to properly account for special metering situations such as check metering, sub metering, prepaid metering and net metering when calculating billing determinants and sending them to billing and other systems.
- e) Shall have the ability to properly account for special situations including, but not limited to, curtailment requests, demand response scenarios (based on use cases provided in Annexure H) when calculating billing determinants and sending them to billing software.
- f) Shall have the ability to facilitate implementation of automatic compensation payments by **MVVNL** to consumers for sustained outages when requested. Compensation calculations would require cross checking with billing and consumer balance information to ensure that disconnection is not construed as a no supply event.

#### 2.4.6 Prepaid functionality

The MDM with the help of the corresponding HES, should be able to switch the Smart Meter between prepaid and post-paid modes by a simple change in configuration of the Smart Meter firmware remotely. The following prepaid functionality shall apply

- a) MDM shall use consumer attributes from Consumer Care System (CCS) and/or **MVVNL** Billing system to,
  - i. enrol and setup new prepaid/ post-paid consumers
  - ii. migrate existing post-paid consumers to prepaid mode and vice versa
- b) An appropriate pre-payment application engine shall support the pre-payment metering capability through the delivered system.

- 
- c) The prepayment system shall ensure that payment and connection parameters are stored centrally, and the details are updated to CIS-CRM/MDM through consumer portal/ app as per Clause 2.5 of this Section. Information required by consumer's Mobile App and web portal are shared in near real time.
  - d) Prepaid consumers shall be provided facility to recharge their account by logging on to the consumer portal/app as per Clause 2.5 of this Section.
    - i. The user interface shall be integrated with the present online payment gateway of the **MVVNL**. Additional payment gateways shall be implemented if required
    - ii. The payment gateways shall facilitate payments through on-line banking, credit cards and payment wallets
  - e) A prepaid mobile application functionality shall be provided as a recharge option for android OS and iOS. The consumer portal/ app, shall enable consumers to recharge as well as view recharge history, existing balance, daily usage etc.
  - f) In addition to billing determinants, the MDM shall share, consumer recharge and credit updates with the **MVVNL** Billing system. Any re-conciliation shall be carried out in the Billing System and the same shall be shared with the MDM for use by the prepayment application.
  - g) The system shall periodically monitor the energy consumption of prepaid consumer and decrease the available credit based on consumption. For this purpose, the MDM shall fetch billing data (kWh/kVAh consumption and MD) at configured intervals<sup>4</sup> from the prepaid meter. The raw billing data shall be subjected to standard VEE rules before being used to update recharge balance with the help of applicable tariff slabs. The credit balance is updated into meter at re-charge time.
  - h) The prepayment application shall use determinants such as minimum fixed charges, TOU tariffs, slab rates, duties & surcharge while calculating consumer credit/balance. Fixed charge shall be deducted on daily basis irrespective of the consumption, even after disconnection of supply and adjusted in the next transaction.
  - i) The prepayment application should be able to automatically apply different TOU tariffs for future date lines, while calculating consumer credits.
  - j) The system should send connect/disconnect command based on available credit as per notified rules & regulations.
  - k) The system should send low-credit notifications to the consumer when their balance approaches a pre-configured threshold. Alerts shall initiate on every recharge, low credit and load connection/disconnection. The alerts shall be posted on the consumer web Portal/ App in real time and sent through SMS and email. Consumer should also be alerted through other mechanisms such as one-time alarm / beep from the meter, LED blinking, message, etc.
  - l) It shall be possible to configure an "emergency" credit limit in INR as well as day terms. This emergency credit shall be used as reserved amount that is consumed when consumer credit is exhausted. The credit amount shall be adjusted in next recharge transaction.

---

<sup>4</sup> The frequency of pre-configured intervals shall be at least every hour in addition to that at re-charge time



- m) It shall be possible to configure certain prepaid consumers where auto-disconnections shall not happen due to negative credit. The conditions/protocols for auto-disconnections are detailed in Annexure I.
- n) The pre-payment function as part of MDM shall also have a facility to configure arrear recovery mechanism to recover arrears from a consumer. Some of the indicative mechanism to recover the same can be recovery of [X]% from every recharge amount while the rest goes as charging amount till all the arrears are recovered. Alternately the arrears may be settled in next [X] instalments as decided by MVVNL such that not more than 50% of any instalment shall be adjusted towards arrear.

#### 2.4.7 Net Metering

MDM shall flag, alarm and trigger an estimating process including but not limited to when the following events occur:

- a) CUM decrements of forward energy within a billing cycle
- b) Register decrements for Time of Use (ToU) of forward energy
- c) Power generated(exported) by any net-metering consumer more than the installed capacity of solar PV rooftop system
- d) Energy exported in any given day by any net-metering consumer more than the programmable threshold value

Like billing for post-paid meters, the billing for net-meters shall take place in the MVVNL Billing server.

#### 2.4.8 Exception Management

- a) Ability to capture and log data exceptions, problems and failures and to generate management reports, provide trend analysis, automate generation of service requests and track corrective actions.
- b) Ability to group, prioritize, filter and send system generated alarms and events to predetermined email addresses, cellular text messages to phone numbers/SMS/consumer care etc. Alternatively, these alarms/alerts may be routed to MVVNL's WFMS.
- c) Exception Generation - MDM shall generate exceptions based on configurable business rules including but not limited to the following:
  - i. Meter tamper alerts
  - ii. Communication module health alerts for meter/DCU
  - iii. If the consumption is less/more than pre-defined average consumption
  - iv. Negative Consumption (not for net-metering)
  - v. Power outage indications received from the Smart Meter

#### 2.4.9 Service Orders

- a) The MDM shall generate service orders based on configurable rules for various events and alarms such as stop meter, tampers, problem in communication networks, etc.

- b) MDM shall send service orders via SMS, email, etc. with the email addresses / phone numbers being configurable. MDM shall receive feedback on action taken on the service order and track the status of service orders until resolution.
- c) Service order tickets could be generated by MDM but processed and closed under jurisdiction of the HES-NMS combine. If the **MVVNL** already has a separate Workforce Management System (WFM), then the service order tickets can be routed from the MDM and the NMS to the WFM for completion of the tasks and reporting.

#### 2.4.10 Revenue Protection Support

- a) Ability to analyse meter tampering flags, power outages, usage trends and usage profiles to identify potential energy diversion situations, and produce daily reports, monthly reports and service order requests for investigation.
- b) The business rules for revenue protection alerts shall be configurable via a user-friendly interface.
- c) The MDM shall filter out revenue protection alerts that may be caused by field activities if the field activity information is provided to the MDM.
- d) The MDM shall support the analytics/investigation (i.e., view current and historical usage patterns) to validate suspected revenue protection issues.

### 2.5 **MVVNL** Interface and Consumer Portal/ App

#### 2.5.1 **MVVNL** User Interface

User interface for **MVVNL** shall have ability for at least the following functionality:

- a) Compare total energy costs on one rate schedule vs. one or many alternative rates.
- b) Enable the user to see how different options within a rate affect costs.
- c) Enable the user to see how adjusting load or consumption levels or shifting them to different time periods influences costs.
- d) Display meter data at a user defined configurable cycle that allows authorized users to view energy usage patterns and the data behind them for selected consumers.
- e) Allow authorized users to view metered data, initiate and view reports, modify configurations, and initiate and update service requests.
- f) Display the energy usage profile for a single meter or group of meters. The load profile shall illustrate energy consumption and peak demand in user defined intervals for a user-specified time period.
- g) Display the energy usage profile for a single meter or group of meters according to Time of Use (ToU) tariff.
- h) The UI shall support a configurable **MVVNL** dashboard for Operations and **MVVNL** Management
- i) Access to a minimum of three (3) years of historical energy usage and meter reads through the UI.
- j) Clearly and visually distinguish between metered, estimated, allocated and substituted data.
- k) User management with roles and access rights

- l) GUI to provide role-based access based on user identity and user role. Shall have following types of users:
  - i. Administrator
  - ii. Operator
  - iii. Field staff
  - iv. Viewer/Guest
- m) Configure the look, feel, and functionality of the MDM in accordance with business needs, business processes, and business conventions. (E.g., GUI, content, look and feel of screens, validation rules, exception handling, etc.).
- n) Ability to set up alarm and event notifications that can be directed to a combination of configurable email addresses, cellular text messages.
- o) UI shall enable viewing of the credit amount updated in MDM for prepaid consumers.
- p) Option to send marketing messages and notification to select consumers or selected category of consumers
- q) Facility to enable or disable existing functionalities/sections of App/Portal for consumers use.
- r) Consumer views to be available to **MVVNL** consumer Service Executive also except payment card/bank information.
- s) Authorised representative to be enabled for consumer engagement analytics. The analytics to be configurable/ generated with minimal database skill and nil programming requirements.
- t) Representative to be able to generate various reports at different intervals the various reports as per Clause 6 of this Section. It shall be also possible to export the report data in multiple formats such as XLS, CSV format, etc.
- u) Provide consumer interactions history to enable efficient consumer complaints and queries resolution with consumer information in single screen.

### 2.5.2 Consumer Portal/ App

Consumer portal and mobile application shall cover all consumer categories and category specific features as applicable prior to operational Go-Live. These apps shall have provision to enable features required to facilitate consumer participation in Demand Response programs which the **MVVNL** may choose to roll out in future. The consumer web portal and the mobile application (for smartphone and tablet devices using latest and commonly available browsers and operating systems and platforms) shall provide consumers, ready access to features extended by MDM. The Solution shall integrate via a user-friendly graphical interface. It shall facilitate self service capabilities such as usage management, billing, service requests, participation in energy efficiency programs etc. It shall be noted that the Consumer Portal / App acts as the bridge between the consumers touch point and the existing **MVVNL** Customer Care and Billing Systems. It does not replace these legacy systems in place. Following features shall be supported by Portal / Mobile app:

- a) The mobile app and web portal shall support all device form factors such as mobile, tablet, desktop etc. by recognising the device details automatically.
- b) It shall be OS agnostic to operating system and devices (iOS, Android, etc.)

- c) It shall work on all standard browsers such as Internet Explorer (IE), Chrome, Safari, Firefox etc.
- d) The application should be modular and scalable a COTS product.
- e) The application should be native for better user experience.
- f) It shall support multiple languages viz Hindi, English and local language(s). Also, notifications should be sent to consumers in local languages.
- g) The user experience of the citizen on the Portal and App shall be similar in terms of look and feel, navigation, menu and access to preferences and other data.
- h) Menu should have navigation options, not limited to, Home, Settings, Recharge, notification preferences, usage rates, change password, terms and conditions, privacy policy, sign out.
- i) It shall have search functionality across all the pages.

Software patches, updates, and version upgrades, when they become available for general release, should be part of ongoing support and maintenance services.

#### **2.5.2.1 Functional Requirements of Consumer Portal/ App**

Web portal and Mobile app for consumers should have minimum following functionalities:

- a) The consumer portal/app shall have a landing Home page. This page shall provide a brief description about the **MVVNL**, any promotional features or advertisement for special programs can be placed in this page. Login Component is provided, and registered users may login using their username and password. New Users can also register by clicking on the First Time Users Register link. The Forgot Password link helps the user to retrieve their password. New users can register by providing their personal information and setting up of security answers. Forgot passwords can be retrieved or reset using OTP through registered mobile number or through email address. The registered users can change their password and account information as well as registered mobile number through OTP feature.
- b) The consumer portal/app shall provide consumers with access to consumer ID, meter ID, meter type and name plate details, besides other account information such as account name, address, balance, due, status etc. Any status message pertaining to the account/s viz. alerts/actions shall be displayed here. It shall also provide current and historical consumption in graphical formats for at least 12 months. A more detailed analysis can be provided in a tabular format listing meter reading date, reading, consumption, charges, selected period etc. Consumers shall be able to view interval data, outage flags, voltage, power quality indications, existing tariffs and incentives for selected period. Information about different consumer engagement programs shall also be displayed here.
- c) The portal/app shall have the ability to provide option for registering in online/paper billing to the consumer. There shall be a bill summary page that shall display bill information in summary and also option for detailed view and download in pdf format if required by consumer. The user shall be able to pay bill for single and multiple accounts.
- d) The portal/app shall be integrated with existing helpdesk of the **MVVNL** and have the ability to provide option for recording service requests/complaints lodged by the consumer as new connection, disconnection, load change, category change, meter shifting etc. The user can view the service request status. The user can register complaints viz. power

- failure, faulty meter, streetlight outage etc. There shall be option to track status of service requests.
- e) Mobile App and Web Portal shall facilitate Chat-bot functionality of the **MVVNL**'s Help Desk. The portal/ App shall support configuration of notification types via email/ SMS/ message/ automated call (through **MVVNL** IVRS), of configured alarms & events.
  - f) The information on consumer identification no., meter ID, name plate details, make, type i.e., 1 Phase or 3 Phase, etc. (as per requirement of **MVVNL**) shall be updated in HES, MDM, and the consumer portal/app.
  - g) The consumer Portal/ App shall have the ability to provide the consumer near real time online views of both usage and cost differentiating high energy usage periods, helping consumers to understand electricity usage and cost information, alerts and notifications and energy savings tips with different levels of detail. The Portal/ App shall support the view for past electricity usage, last week's, yesterday's, current days or other period etc. as per selection as well as voltage and power quality indications. The portal/ app shall provide user friendly access to consumer for their data via graphs and charts and can download the data into a spreadsheet.
  - h) The portal/app shall provide option to the consumer to view/download online bill. There shall be a bill summary page that shall display bill information in summary and option for detailed view and download in pdf format. The user shall be able to pay bill for single and multiple accounts.
  - i) The portal/app shall also provide platform for implementation of peak load management functionality by providing existing tariff & incentives rates, participation options etc. The portal/app shall also provide consumers with interval data, flags, voltage, power quality indications etc. Show outage information in map view.
  - j) There should be different UI and landing pages for different type of consumers as per the need of **MVVNL**.
  - k) User interface to consumer Portal/ App to access consumer's data from MDM for all authorized consumers shall have ability for at least the following functionality:
    - i. View metered data, monthly average usage, current monthly consumption, maximum demand and other reports
    - ii. View data according to Time of Use (ToU), day, week, month, year and season etc.
    - iii. Update profile information such as mobile number/email etc.
    - iv. Guest user account/multi-user account access facility for consumer convenience
    - v. Initiate request for connection/disconnection
    - vi. Initiate request to switch between pre-paid and post-paid mode
    - vii. Initiate service requests for maximum demand updating, meter checking etc.
    - viii. Initiate complaints such as Meter not working, supply off etc.
    - ix. In case on net-metering consumers, user can view data for both import & export data
    - x. Can view recharge history, present balance, next possible recharge date and amount etc.
    - xi. Historical energy consumption and energy charges during the desired time period
    - xii. Facility to recharge their account through the payment gateway facilitated by the **MVVNL**.

## 2.6 Network Operation & Monitoring Centre

The Network Operations and Monitoring Centre shall cater to the needs of the,

- Project Management Team and the
- AMI network operations team

The Network operation and monitoring centre shall be created in the **MVVNL** premises by the AMISP, for which suitable built-up space shall be provided by the **MVVNL**. The built-up space to be arranged by the **MVVNL**, shall be properly air conditioned, illuminated, and adequate for at least five operator workstations and one cabin for a supervisor.

The AMISP is required to suggest a suitable architecture for the Network Operation & Monitoring Centre, taking care of the security requirements as described in this document. AMISP shall establish connectivity between the workstations located at the NOMC with that of the cloud-based MDM-HES system. In addition, the AMISP shall establish connectivity between the cloud-based MDM system with **MVVNL**'s existing Billing system. This will necessitate creation of a VPN tunnel between the two unless it is decided to migrate the Billing system to the same cloud data centre.

The AMISP must submit the details of the supplied hardware along with the Bid. The AMISP shall assess the adequacy of hardware specified in the List of Material and Services & if any additional hardware or higher end hardware configurations are required to meet all the requirements of the Technical Specifications, the same shall be included in the offer.

### 2.6.1 General Requirements for NOMC Hardware

All hardware shall be manufactured, fabricated, assembled and finished with workmanship of the highest production quality and shall conform to all applicable quality control standards of the original manufacturer and the AMISP. All hardware components shall be new and suitable for the purposes specified.

All workstations and network equipment (routers, firewall etc.) shall be compatible for remote monitoring using secure Simple Network Management Protocol (SNMP) Ver. 3.0. All hardware shall support IPv6 simultaneously.

The AMISP shall ensure that at the time of final approval of hardware configuration and List of Material and Services, all the hardware is as per the current industry standard models and that the equipment manufacturer has not established a date for termination of its production. Any hardware changes, except version upgrade in same series, proposed after contract agreement shall be subject to the following:

- a) Such changes/updates shall be proposed, and approval obtained from the **MVVNL** along with the approval of Drawings/documents.
- b) The proposed equipment shall be equivalent or with better features than the equipment included in the Contract.
- c) Complete justification along with a comparative statement showing the original and the proposed hardware features/parameters including brochures shall be submitted to the **MVVNL** for review and approval.
- d) Changes/updates proposed will be at no additional cost to the **MVVNL**.
- e) The porting of software shall be at no additional cost in case of replacement of hardware during the contract period.

### 2.6.2 Minimum Technical Requirements for NOMC Hardware

The network operation and monitoring centre shall be equipped with the following minimum hardware components:

- a) Six numbers 17" Operator workstations including one for Supervisor
- b) A dual redundant 1 Gbps local area network

- c) Internet router with at least 48 no's 1 Gbps LAN ports and redundant at least 2 Gbps internet ports supporting IPsec, and SSLVPN capability
- d) Firewall and intrusion protection system
- e) One video display system of at least 70-inch diagonal with laser light source HD cube (DLP technology) supported by,
  - i. Dual power supply
  - ii. IP based control options and
  - iii. Display Port, DVI, HDMI and Analog D-Sub signal interfaces
- f) One A3/A4 size laser jet B/W printer with LAN interface
- g) One A4 size ink jet colour printer with LAN interface
- h) One dual redundant online UPS to support the load of the above-mentioned equipment with minimum 2 hours backup
- i) 2 Gbps internet connectivity

The minimum technical specification and requirement to be followed for hardware equipment is as per the table below. < *Hardware Requirements and minimum specification to be defined as per **MVVNL** requirement*>.

Hardware Item	Minimum Specification	Quantity
Firewall		[X]
WAN Router		[X]
Workstation Console		[X]
Printers		[X]

## 2.7 System Software Requirements

This section describes the standards and characteristics of system software such as operating system, database and support software (compilers, DBMS, display development, network utilities, report generation, diagnostics and backup utilities) provided by AMISP and the original software manufacturer as necessary to support the functioning of AMI Applications systems. All the system software to be used for the present scope of work shall have valid license(s).

### 2.7.1 Software Standards

All software provided by the AMISP under this RFP, including the operating system, database and support software, shall comply with the industry-accepted software standards. In areas where these organizations have not yet set standards, the software shall comply with those widely accepted de-facto open standards put forth by industry consortiums, such as Open Software Foundation (OSF) and X/Open. The AMISP shall commit to meet the "open systems" objective promoted by industry standards groups.

#### 2.7.1.1 Design and Coding Standards for AMI Applications and Utilities

These provisions are applicable for both software applications and operating systems and would address program features that must be contained in software for the product to meet the standards.

- a) When software is designed to run on a system that has a keyboard, product functions shall be executable from a keyboard where the function itself or the result of performing a function can be distinguished textually.
- b) A well-defined on-screen indication of the present focus shall be provided that moves among interactive interface elements as the input focus changes.

- c) Applications shall not override user selected contrast and colour selections and other individual display attributes.

When animation is displayed, the information shall be displayable in at least one non-animated presentation mode at the option of the user

#### 2.7.1.2 Applications

All components of AMI application system shall be maintainable by owner using the supplied software utilities and documentation. The software design and coding standards of the system shall address the followings:

- a) **Expansion:** Software shall be dimensioned to accommodate the size of AMI application system as given in List of Material and Services (as mentioned in this RFP) and Annexure E.
- b) **Modularity:** Software shall be modular i.e. functionally partitioned into discrete, scalable, reusable modules consisting of isolated self-contained functional elements and designed for ease of change. The system shall make maximum use of common industry standards for interfaces.
- c) **User-Directed Termination:** Functions taking long execution times shall recognize and process user requests to abort the processing.
- d) **Portability & Interoperability:** The system shall be designed for hardware independence and operation in a network environment that facilitates interoperability and integration of third-party applications. AMI applications should support multiple Relational Database Management Systems (RDBMS) including Oracle, Microsoft SQL Server and MySQL.
- e) **Programming Languages:** The software shall be written using high level ISO or ANSI standard programming languages.

All applications shall be designed with sufficient background logs which capture various level of errors encountered (warning, fatal, informational) while executing, so that the same can be reviewed and attended to.

#### 2.7.1.3 Operating System

The operating system of all the equipment of AMI application system including network equipment shall be latest version released up to six months prior to FAT. The operating system shall be hardened to provide robust security. The operating system and data file shall be placed in different disk partitions.

In order to facilitate cyber security requirements including patch management, common operating system is preferable to be used by all server nodes within the AMI application including MDM/HES servers. This is also to minimize the maintenance. All licenses for Operating System and other application software shall be supplied by the AMISP and shall be valid throughout the contract period.

#### 2.7.1.4 Time and Calendar Feature

The AMI application & other servers shall maintain time and calendar for use by various software applications. The internal clocks of all servers and workstation consoles shall be automatically synchronized on Network Time Protocol (NTP) protocol. The calendar shall be customizable for working hours, holidays, weekends etc. The holidays, including type of days,



shall be entered for each year at the beginning of the year and shall be recognized by all applications.

#### **2.7.1.5 Remote Diagnostic**

Remote Diagnostic facility with necessary hardware as required shall be provided for communication between the AMI application system at the cloud data centre and the NOMC for the diagnosis of hardware & software problems. The login shall be protected by a username & password entry. An automatic logging and intimation shall be provided to inform authorized person from AMISP/MVVNL on such events of remote access and diagnosis.

#### **2.7.1.6 Development System as a Test Bench**

A Development system independent of the production environment shall be defined at the cloud data centre which shall provide testing facility for integration of changes/modifications of the AMI application and new field devices before putting it online with Real-time system. This Development system shall be on a VLAN separated from the production VLAN and shall be self-sufficient to carryout testing of changes/ modifications.

### **2.7.2 Network Communication**

The network communications software shall use a standard network protocol such as TCP/IP, UDP etc. and shall support IPv6. The software shall link dissimilar hardware nodes such as local and remote workstations and peripheral devices into a common data communication network allowing communications among these devices. The network communication software shall include-network security, security management, patch management and network services of the AMI system. Network communication software shall have scalability feature as envisaged.

### **2.7.3 Cloud Service Providers (CSP)**

This section mentions key requirements from the Cloud Service Provider (CSP). AMISP shall be responsible to provide the services of CSP.

#### **2.7.3.1 General Conditions**

The cloud data centre shall have to comply with requirements of tier III category which applies to a concurrently maintainable site infrastructure with redundant capacity components and multiple independent distribution paths serving the critical environment. All IT equipment shall be dual powered. The following general conditions will apply:

- a) Only GI (MeghRaj) cloud services or Meity empanelled Cloud services should be used.
- b) One of the most critical issues in the Cloud Service implementation is the security of the data. It is the responsibility of the AMISP to define the security services that need to be implemented for their workloads depending on the nature of the applications / data hosted on the cloud.
- c) AMISP need to ensure that the CSPs facilities/services are compliant to various security standards (as mentioned in Clause 2.7.3.4 of this Section) and should be verified by third party auditors.
- d) CSP should suitably address all the potential risks and issues in cloud implementation including data security and privacy, increased complexity in integration with existing environments, vendor lock-in, application portability between different platforms, exit management / Transition-Out Services etc.
- e) The AMISP shall be responsible for providing the cloud data centre services. It shall be up to the AMISP, to identify the critical service agreements with the concerned cloud data

centre provider in order that the AMISP can meet and sustain the SLA for the AMI project as per Clause 7.7 of this Section.

- f) All Services including data should be hosted in India
- g) Exit Management / Transition-Out Services -The responsibilities of the CSP during the Exit Management Period need to be agreed upon with the **MVVNL** and they should assist the **MVVNL** in migrating the data etc.
- h) The responsibilities of CSP include migration of the data, content and any other assets to the new environment or on alternate cloud service provider's offerings and ensuring successful deployment and running of the **MVVNL**'s Solution on the new infrastructure
- i) The ownership of the data generated upon usage of the system, at any point of time during the contract or expiry or termination of the contract, shall rest absolutely with the **MVVNL**.

The AMISP may also choose to procure the following Managed Services (O&M – Cloud Services) from a Managed Service Provider (MSP) in addition to the cloud services to handhold the department in managing the operations on the cloud. The scope of MSP may include:

- a) Migration of Existing Applications to Cloud / Deploying of new applications;
- b) Operations & Maintenance Services on Cloud (e.g., Resource Management, User Administration, Security Administration & Monitoring of Security Incidents, Monitoring Performance & Service Levels, Backup, Usage Reporting and Billing Management)
- c) Exit Management & Transition-out Services, etc.

### 2.7.3.2 MeitY's Guidelines

While the security, storage, data and compliance tools are provided by the CSP, it is the AMISP's responsibility to ensure that the CSPs facilities/services are certified to be compliant to standards.

In the MeitY's guidelines to Government Departments on Adoption / Procurement of Cloud Services, the following are included as essential certification by CSP. AMISP also needs to ensure that the CSPs facilities/services are certified to be compliant to the following standards (indicative list provided below):

- a) ISO 27001 - Data Center and the cloud services should be certified for the latest version of the standards towards information security management system
- b) ISO/IEC 27017:2015-Code of practice for information security controls based on ISO/IEC 27002 for cloud services and Information technology
- c) ISO 27018 - Code of practice for protection of personally identifiable information (PII) in public clouds.
- d) ISO 20000-1 – Information Technology service management system requirements
- e) The CSP's Data Center should conform to at least Tier III standard (preferably certified under TIA 942 or Uptime Institute certifications by a 3rd party) and implement tool-based processes based on ITIL standards.
- f) Payment Card Industry (PCI) DSS - compliant technology infrastructure for storing, processing, and transmitting credit card information in the cloud

### 2.7.3.3 Functional Requirements of the CSP

#### 2.7.3.3.1 Operational Management

- a) CSP should provide access of cloud virtual machines either by SSH in case of Linux and RDP in case of Windows servers.
- b) CSP should enable **MVVNL** to get console access of cloud virtual machine from portal and perform operations. There should be facility to view resource type-wise (VM, database, storage etc.) quota usage. It should be possible to configure automated alerts when the threshold of estimated quota is reached.
- c) CSP should upgrade its hardware time to time to recent configuration to delivery expected performance for this Project.
- d) Investigate outages, perform appropriate corrective action to restore the hardware, operating system, and related tools.
- e) CSP should manage their cloud infrastructure as per standard ITIL framework in order to delivery right services to Project.
- f) The CSP should allow different users with different level of access on CSP portal. For example, billing user should not be able to provision resources or delete any resources
- g) The CSP should allow quota management for each department/ISV/Group. The resources to specific department/group/ISV should be as per allocated quota only. If there is any request for more than quota request, then it should be sent as request to admin.

#### 2.7.3.3.2 Compatibility Requirements

- a) CSP should provide capability to import a Virtual Machine (VM) as an image and support standard formats such as OVA, VMDK, VHD, and raw.
- b) CSP should give provision to import cloud VM template from other cloud providers.
- c) CSP should ensure connectivity to and from cloud resources used for this project is allowed to/ from other cloud service providers if required.

#### 2.7.3.3.3 Cloud Network Requirement

- a) CSP must ensure that the non-production and the production environments are in separate VLANs in the cloud so that users of the two environments are separated.
- b) CSP must ensure that cloud VM are having private IP network assigned.
- c) CSP must ensure that all the cloud VMs are in same network segment (VLAN) even if they are spread across multi data centres of CSP.
- d) CSP should ensure that cloud VMs are having Internet and Service Network (internal) vNIC cards.
- e) CSP should ensure that Internet vNIC card is having minimum 1 Gbps network connectivity and service NIC card is on 10 Gbps for better internal communication.

- f) In case of scalability like horizontal scalability, the CSP should ensure that additional network is provisioned automatically of same network segment.
- g) CSP must ensure that public IP address of cloud VMs remains same even if cloud VM gets migrated to another data centre due to any incident.
- h) CSP must ensure that public IP address of cloud VMs remains same even if cloud VM network is being served from multiple CSP data centres.
- i) CSP must ensure that the public network provisioned for cloud VMs is redundant at every point.
- j) CSP must ensure that cloud VMs are accessible from **MVVNL** private network if private links P2P/MPLS is used by **MVVNL**
- k) CSP must ensure that there is access to cloud VMs if **MVVNL** requires to access it using IPSEC/SSL or any other type of VPN.
- l) CSP should ensure that cloud VM network is IPV6 compatible.
- m) CSP should ensure use of appropriate load balancers for network request distribution across multiple cloud VMs.

#### **2.7.3.3.4 Cloud data centre specifications**

- a) All the physical servers, storage and other IT hardware from where cloud resources are provisioned for this project must be within Indian data centres only.
- b) Selection of DC-DR site architecture shall be in accordance with applicable laws including but not limited to the “Disaster Recovery Best Practices” guidelines issued by the Ministry of Electronics & Information Technology (MEITY) and as amended from time to time”.
- c) The CSP data centres should have adequate physical security in place.
- d) The Data Centre should conform to at least Tier III standard (preferably certified under TIA 942 or Uptime Institute certifications by a 3rd party) and implement tool-based processes based on ITIL standards.

#### **2.7.3.3.5 Cloud Storage Service Requirements**

- a) CSP should provide scalable, dynamic and redundant storage.
- b) CSP should offer provision from self-provisioning portal to add more storage as and when require by respective Utilities.
- c) CSP should clearly differentiate its storage offering based on IOPS. There should be standards IOPS offering per GB and high-performance disk offering for OLTP kind of workload.
- d) CSP should have block disk offering as well as file/object disk offering to address different kind of Project needs.
- e) The CSP should retain AMI data for [x] years *<where x shall be defined based on regulatory provisions>*

### 2.7.3.3.6 Cloud Security Requirements

- a) CSP should ensure there is multi-tenant environment and cloud virtual resources of this project are logically separated from others.
- b) CSP should ensure that any OS provisioned as part of cloud virtual machine should be patched with latest security patch.
- c) In case, the CSP provides some of the System Software as a Service for the project, CSP is responsible for securing, monitoring, and maintaining the System and any supporting software.
- d) CSP should implement industry standard storage strategies and controls for securing data in the Storage Area Network so that clients are restricted to their allocated storage
- e) CSP should deploy public facing services in a zone (DMZ) different from the application services. The Database nodes (RDBMS) should be in a separate zone with higher security layer.
- f) CSP should give ability to create non-production environments and segregate (in a different VLAN) non-production environments from the production environment such that the users of the environments are in separate networks.
- g) CSP should have built-in user-level controls and administrator logs for transparency and audit control.
- h) CSP cloud platform should be protected by fully managed Intrusion detection system using signature, protocol, and anomaly-based inspection thus providing network intrusion detection monitoring.

### 2.7.3.3.7 Data Management

- a) CSP should clearly define policies to handle data in transit and at rest.
- b) CSP should not delete any data at the end of agreement without consent from **MVVNL**.
- c) In case of scalability like horizontal scalability, the CSP should ensure that additional generated data is modify/deleted with proper consent from **MVVNL**.

### 2.7.3.3.8 Managed Services

- a) Network and Security Management:
  - i. Monitoring & management of network link proposed as part of this Solution. Bandwidth utilization, latency, packet loss etc.
  - ii. Call logging and co-ordination with vendors for restoration of links, if need arises.
  - iii. Addressing the ongoing needs of security management including, but not limited to, monitoring of various devices / tools such as firewall, intrusion protection, content filtering and blocking, virus protection, and vulnerability protection through implementation of proper patches and rules.

- iv. Ensuring that patches / workarounds for identified vulnerabilities are patched / blocked immediately
  - v. Ensure a well-designed access management process, ensuring security of physical and digital assets, data and network security, backup and recovery etc.
  - vi. Adding/ Changing network address translation rules of existing security policies on the firewall
  - vii. Diagnosis and resolving problems related to firewall, IDS/IPS.
  - viii. Managing configuration and security of Demilitarized Zone (DMZ) Alert / advise **MVVNL**(s) about any possible attack / hacking of services, unauthorized access / attempt by internal or external persons etc.
- b) Server Administration and Management:
- i. Administrative support for user registration, User ID creation, maintaining user profiles, granting user access, authorization, user password support, and administrative support for print, file, and directory services.
  - ii. Installation/ re-installation of the server operating systems and operating system utilities
  - iii. OS Administration including troubleshooting, hardening, patch/ upgrades deployment, BIOS & firmware upgrade as and when required/ necessary for Windows, Linux or any other O.S proposed as part of this solution whether mentioned in the RFP or any new deployment in future.
  - iv. Ensure proper configuration of server parameters, operating systems administration, hardening and tuning
  - v. Regular backup of servers as per the backup & restoration
  - vi. Managing uptime of servers as per SLAs.
  - vii. Preparation/ update of the new and existing Standard Operating Procedure (SOP) documents on servers & applications deployment and hardening.

#### 2.7.3.3.9 Business Continuity Plan & Backup Services

As part of a business continuity plan, the **MVVNL** has made a business impact analysis in the event of loss of AMI applications running in the cloud and consequent loss of data to come up with a management plan for the associated risk to business operations. Central to this risk management strategy, the **MVVNL** has defined the following target objectives:

- a) **Recovery Time Objective (RTO):** Duration of time and a service level within which a business process must be restored after a disruption in order to avoid unacceptable consequences associated with a break in continuity of service. The RTO of [4 hours] shall be met by infrastructure redundancy and failover.
- b) **Recovery Point Objective (RPO):** Interval of time that may pass during a disruption before the quantity of lost data during that period exceeds the business continuity plan's maximum allowable threshold. The RPO of [2 hours] shall be met by a suitable backup and replication strategy of operational data / application.

The RPO shall define how fast the replicated data / application can be made available to the target system after a disruption strikes.

With these two objectives, the CSP shall provide the following:

- a) CSP must provide backup of cloud resources. The backup tool should be accessible
- b) To perform backup and restore management as per policy & procedures for backup and restore, including performance of daily, weekly, monthly, quarterly and annual backup functions (full volume and incremental) for data and software maintained on the servers and storage systems using Enterprise Backup Solution.
- c) Backup and restoration of Operating System, application, databases and file system etc. in accordance with defined process / procedure / policy. Monitoring and enhancement of the performance of scheduled backups, schedule regular testing of backups and ensure adherence to related retention policies
- d) Ensuring prompt execution of on-demand backups & restoration of volumes, files and database applications whenever required.
- e) Real-time monitoring, log maintenance and reporting of backup status on a regular basis. Prompt problem resolution in case of failures in the backup processes.
- f) Media management including, but not limited to, tagging, cross-referencing, storing (both on-site and off-site), logging, testing, and vaulting in fireproof cabinets if applicable.
- g) Generating and sharing backup reports periodically
- h) Coordinating to retrieve off-site media in the event of any disaster recovery
- i) Periodic Restoration Testing of the Backup
- j) Maintenance log of backup/ restoration
- k) CSP should provide network information of cloud virtual resources.
- l) CSP must offer provision to monitor network uptime of each cloud VM.

#### **2.7.3.3.10 Web Application Firewall (WAF) as Service**

- a) Cloud platform should provide Web Application Filter for OWASP Top 10 protection
- b) CSP WAF should be able to support multiple website security.
- c) CSP WAF should be able to perform packet inspection on every request covering the 7th layers.
- d) CSP WAF should be able to block invalidated requests.
- e) CSP WAF should be able to block attacks before it is posted to website.
- f) CSP WAF should have manual control over IP/Subnet. i.e., Allow or Deny IP/Subnet from accessing website.

- g) The attackers should receive custom response once they are blocked.
- h) CSP must offer provision to customize response of vulnerable requests.
- i) CSP WAF should be able to monitor attack incidents and simultaneously control the attacker IP.
- j) CSP WAF should be able to Grey list or Backlist IP/Subnet.
- k) CSP WAF should be able to set a limit to maximum number of simultaneous requests to the web server & should drop requests if the number of requests exceed the threshold limit.
- l) The WAF should be able to set a limit to maximum number of simultaneous connections per IP. And should BAN the IP if the threshold is violated.
- m) CSP WAF should be able to set a limit to maximum length of path to URL.
- n) CSP WAF should be able to limit maximum size of request to Kilobytes.
- o) CSP WAF should be able to limit maximum time in seconds for a client to send its HTTP request.
- p) CSP WAF should be able to BAN an IP for a customizable specified amount of time if the HTTP request is too large.
- q) CSP WAF should be able to limit maximum size of PUT request entity in MB
- r) The WAF should be able to close all the sessions of an IP if it is ban.
- s) CSP WAF should be able to ban IP on every sort of attack detected and the time span for ban should be customizable. There should be a custom response for Ban IP.
- t) The Dashboard should show a graphical representation of
  - i. Top 5 Attacked Websites.
  - ii. Top 5 Attacking IP.
  - iii. Top 5 Attack types.
  - iv. Top 5 Attacked URLs.
- u) For analysis purpose the Dashboard should contain following information:
  - i. Number of requests to web server.
  - ii. Number of attacks.
  - iii. Number of Attackers.
  - iv. Types of error messages and on. Of error messages sent to the users.
  - v. Total Bytes sent during transaction

#### **2.7.3.3.11 Database support service**

- a) Installation, configuration, maintenance of the database (Cluster & Standalone).
- b) Regular health check-up of databases.



- c) Regular monitoring of CPU & Memory utilization of database server, Alert log monitoring & configuration of the alerts for errors.
- d) Space monitoring for database table space, Index fragmentation monitoring and rebuilding.
- e) Performance tuning of Databases.
- f) Partition creation & management of database objects, Archiving of database objects on need basis.
- g) Patching, upgrade & backup activity and restoring the database backup as per defined interval.
- h) Schedule/review the various backup and alert jobs.
- i) Configuration, installation and maintenance of Automatic Storage Management (ASM), capacity planning/sizing estimation of the Database setup have to be provided and taken care by the AMISP.
- j) Setup, maintain and monitor the 'Database replication' / Physical standby and Assess IT infrastructure up-gradation on need basis pertaining to databases

#### 2.7.3.3.12 Factory acceptance testing:

- a) The functional performance test shall verify all features specified in respective technical specifications of equipment/ systems along with cloud services & software using selected communication paths.
- b) The data exchange between central systems shall also be simulated in the factory test environment. Contractor shall submit the documents for tests and test procedures for approval of **MVVNL**.

#### 2.7.3.4 Security

Further, commercial CSPs offer cloud services to multiple consumers. In such an environment, the security controls and compliance to various standards (Including ISO 27001, ISO 27017, and ISO 27018) should be verified by third party auditors. Third-party certifications and evaluations provide assurance that effective physical and logical security controls are in place.

Although, the Cloud Service Providers (CSPs) offer assurances of effective physical and logical security controls through the third-party certifications such as ISO 27001, ISO 27017, ISO 27018, etc. and also may provide a host of security services such as encryption, web application firewall, etc., it is the responsibility of the AMISP to define the security services that need to be implemented for their workloads depending on the nature of the applications / data hosted on the cloud.

Now a days, CSPs offer tools and features to help consumers to meet their security objectives concerning visibility, auditability, controllability, and agility. These tools and features provide basic but important security measures such as Distributed Denial of Service (DDoS) protection and password brute-force detection on CSP's accounts.

However, the following basic security features should be ensured by any CSP-

- a) Strong encryption capabilities for data in transit or at rest
- b) Firewalls – instance and subnet levels

- c) Identity and Access Management (IAM): Control users' access to cloud services. Create and manage users and groups, and grant or deny access
- d) Managed Threat Detection: Managed threat detection service that provides you with a more accurate and easy way to continuously monitor and protect your cloud accounts and workloads
- e) Managed DDoS Protection: Managed Distributed Denial of Service (DDoS) protection service that safeguards web applications running on cloud.
- f) Web Application Firewall: Helps protect your web applications from common web exploits that could affect application availability, compromise security, or consume excessive resources.
- g) Key Management Service (KMS): Managed service that makes it easy for you to create and control the encryption keys used to encrypt your data
- h) Certificate Manager: Easily provision, manage, and deploy Secure Sockets Layer/Transport Layer Security (SSL/TLS) certificates.
- i) Cloud HSM: Meet regulatory compliance requirements for data security by using dedicated Hardware Security Module (HSM) appliances within the Cloud.
- j) Inspector: Automated security assessment service that helps improve the security and compliance of applications deployed on cloud
- k) Organizations: Policy-based management for multiple consumer accounts. With Organizations, you can create groups of accounts and then apply policies to those groups.

CSPs also offers access to additional third-party security tools (e.g., IDS / IPS, SIEM) to complement and enhance the consumers' operations in the Cloud. The third-party security tools complement existing Cloud services to enable consumers to deploy a comprehensive security architecture. These security tools on cloud are equivalent and identical to the existing controls in an on-premises environment.

The AMISP needs to review and validate the security configurations, review the notifications and patches released by the CSP and validate that the same is being taken into consideration during operations, confirm that the audit trails (e.g., who is accessing the services, changes to the configurations, etc.) are captured for supporting any downstream audits of the projects by the finance or audit organization such as STQC.

#### **2.7.3.5 Reporting**

Further, the AMISP should insist on the following regular reporting by CSP during the contract:

- a) Availability of the cloud services being used
- b) Summary of alerts that are automatically triggered by changes in the health of those services.
- c) Summary of event-based alerts, providing proactive notifications of scheduled activities, such as any changes to the infrastructure powering the cloud resources
- d) Reports providing system-wide visibility into resource utilization, application performance, and operational health through proactive monitoring (collect and track metrics, collect and monitor log files, and set alarms) of the cloud resources

- e) Auto-scaling rules and limits
- f) In case of any un-authorized access, the Agency should provide logs of all user activity within an account, with details including the identity of the API caller, the time of the API call, the source IP address of the API caller, the request parameters, and the response elements returned by the cloud service. This is required to enable security analysis, resource change tracking, and compliance auditing
- g) Report of all the provisioned resources and view the configuration of each.
- h) Summary of notifications, triggered each time a configuration changes
- i) Incident Analysis in case of any un-authorized configuration changes.
- j) Summary of alerts with respect to security configuration gaps such as overly permissive access to certain compute instance ports and storage buckets, minimal use of role segregation using Identity and Access Management (IAM), and weak password policies
- k) Summary of security assessment report that identifies the possible improvements (prioritized by the severity) to the security and compliance of applications deployed on cloud
- l) Report on upcoming planned changes to provisioning, either possible optimizations, if any, indicating how the underutilized services can be reduced to optimize the overall spend, or required enhancements (e.g., upgrade to additional storage) to meet the service levels defined in the RFP.

## 2.7.4 Database

### 2.7.4.1 Initial Database Generation

#### Development Tools

The AMISP shall provide all necessary software tools for the development and maintenance of the databases required for AMI application.

This tool shall be capable of managing the entire system database. The database development software tool delivered with the system shall be used to generate, integrate and test the database. The system must support export of data into XML format.

The database development tool shall facilitate exchange of both incremental and full data in standard exchange format. The product should have facility to export and import databases from different vendors applications.

### 2.7.4.2 Management

The database manager shall locate, order, retrieve, update, insert, and delete data; ensure database integrity; and provide backup and recovery of database files. The database manager shall generate and modify all AMI application data by interfacing with all database structures. In systems with a distributed database, the database manager shall have access to all portions of the database wherever stored.

Execution of the database manager in any server of the system shall not interfere with the on-line functions of AMI applications including the normal updating of each server's real-time database. In a primary server, database editing shall be limited to viewing functions, database documentation functions and functions that change the contents but not the structure of the

database. Editing the on-line database shall not affect the operation of the primary/backup configuration.

The database manager shall include the mechanisms, in both interactive and batch processing modes, to perform the following functions:

- a) Add, modify and delete database items and data sources such as data links, and local I/O.
- b) Add, modify and delete application program data
- c) Create a new database attribute or new database object
- d) Resize the entire database or a subset of the database
- e) Redefine the structure of any portion of the database.

The AMISP shall be required to provide whether they require or impose any particular hardware and database management techniques to achieve above functionality.

#### **2.7.4.3 Tracking Changes**

The database manager **MVVNL** shall maintain Audit trail files for all changes made by all users (both online/off-line). The audit trails shall identify each change including date and time stamp for each change and identify the user making the change. Audit trail of past [1] year edit operations shall be maintained.

#### **2.7.4.4 Integration**

The System should support exchange of data from **MVVNL**'s computerized billing & collection, consumer indexing and asset mapping systems residing at different servers.

### **2.7.5 Display Generation, Management and Integration (Display Management and Reporting)**

The AMISP shall provide necessary software tools preferably browser based for the generation, management and Integration of AMI application displays.

The displays shall be generated and edited interactively using this display generation software delivered with the system. All displays, symbols, segments, and user interaction fields shall be maintained in libraries. The size of any library and the number of libraries shall not be constrained by software. The display generator shall support the creation, editing, and deletion of libraries, including copying of elements within a library and copying of similar elements across libraries. Execution of the display generator functions shall not interfere with the on-line AMI application functions.

Displays shall be generated in an interactive mode. The user shall be able to interactively:

- a) Develop display elements
- b) Link display elements to the database via symbolic point names
- c) Establish display element dynamics via database linkages
- d) Define linkages to other displays and programs
- e) Combine elements and linkages into display layers
- f) Combine display layers into single displays.

All workstation features and all user interface features defined in this specification shall be supported by the display generator software.

The display generator shall support the addition, deletion and modification of segments, including the merging of one segment with another to create a new segment.

Displays shall not be limited by the size of the viewable area of the screen.

The displays shall be constructed from the display elements library. The display definition shall allow displays to be sized to meet the requirements of the AMI application for which they are used. The display generation software shall allow unbroken viewing of the display image being built as the user extends the size of the display beyond the screen size limits.

The display generator shall support the integration of new and edited displays into the active display library. During an edit session, the display generation software shall allow the user to store and recall a partial display. To protect against loss of display work when a server fails, the current work shall be automatically saved every five minutes (user adjustable) to an auxiliary memory file.

The display generator shall verify that the display is complete and error-free before integrating the display into the active display library. It shall not be necessary to regenerate any display following a complete or partial system or database generation unless the database points linked to the display have been modified or deleted.

The system shall generate reports for all the modules in user-defined formats. The system will have a graphical user interface with a capability for generating customized reports, apart from the regular ones mentioned above, as per the requirement of management and operations staff. Display of statistical data shall be presented additionally in graphical formats such as bar-graph/pie diagram etc. for convenience of analysis.

#### **2.7.6 Software Utilities**

AMISP shall supply all software utilities used to develop and maintain these software, whether or not specifically described by this Specification. The software utilities shall operate on-line (in background mode) without jeopardizing other application functions running concurrently. **MVVNL** software shall be accessible from workstations, processor terminals and servers.

##### **2.7.6.1 Auxiliary Memory Backup Utility**

Software utility, to take back-up of auxiliary memory files of server and workstation onto a user- selected archival device such as SAN, shall be installed. Backup shall be maintained for the entire duration of contract period. The backup utility shall allow for user selection of the files to be saved based on:

- a) Server and workstation
- b) File names (including directory and wildcard designations)
- c) File creation or modification date and time
- d) Whether or not the file was modified since the last backup.

Further a utility for taking image backup of auxiliary memory files of the Servers and workstations shall be provided. The **MVVNL** shall allow restoration of the servers/workstation from this image backup without requiring any other software. An image backup of the as built system of each of the Servers and workstations shall be provided on a user-selected archival device such as SAN, which shall be used to restore the system. Automatic full or incremental back up capability of selected systems at user defined intervals shall be provided. It should be possible to restore or recover any software/system at a selected time from backup.

##### **2.7.6.2 On-Line Monitoring Diagnostics Utility**

On-Line monitoring diagnostic programs shall be provided for verifying the availability of the backup equipment and for limited testing of devices without interfering with on-line operations of AMI application system or the failover capability of the devices.

Redundant communication line interface equipment shall be tested by periodically retrieving data over these lines and checking for the ability to communicate with the redundant channel for any errors.

Designated backup server(s) and associated auxiliary memories shall be automatically tested for proper operation to ensure they are ready if needed for a failure over contingency. Any failure to perform diagnostic functions correctly shall cause an alarm to be issued.

### **2.7.6.3 Data Exchange Utilities**

Facility of data export and import between this system and external systems shall be provided through web services.

### **2.7.6.4 Other Utility Services**

AMI Application management shall include the following utility services:

- a) Loading and storage of information from labelled portable media storage units as dictated by the requirements of this specification.
- b) Preparation of .pdf output for the displays/reports available in the AMI Application system. It should also be possible to export all the reports to any MS-Office format.
- c) Displays and Reports for Web server -The AMISP shall provide utilities for preparing displays and reports suitable for Web publishing. These utilities shall be used to generate, all required displays and reports from the system displays and reports, automatically (without requiring rebuilding).
- d) Online access to user and system manuals for all software products (e.g., Operating System and Relational Database Software) and AMI applications shall be provided with computer system
- e) Antivirus Software - All computers and firewalls shall be provided with the latest antivirus software as on date of supply. The antivirus software shall have the capability of having its virus definitions updated from time to time. The AMISP shall be responsible for the maintenance & update of the antivirus software during the contract period.
- f) Software Upgrade-The AMISP shall be responsible for the maintenance & update of the patches and signatures of operating system, applications (AMI Applications) system and Web based System up to the contract period.
- g) Automated patch management and anti-virus tools shall be provided to expedite the distributions of patches and virus definitions to the system using an orchestration facility.

These tools should consider the possibility to use standardized configurations for IT resources.

### **2.7.7 Cyber Security – General Guidance**

Cyber security governance problems are unique as well as evolving therefore, they cannot be dealt with a traditional approach. For establishing secure and resilient Smart Meter systems, a standardized cybersecurity framework should be adopted by the AMISP in consultation with the **MVVNL** and relevant stakeholders. The key elements of the cyber security framework must include:

- a) Differentiation of stakeholders into broad categories to aid in proper distribution of responsibilities among stakeholders and avoid overlapping

- b) Defined set of responsibilities for each stakeholder group. As a result, the decision-making process is streamlined, and proper management hierarchy is established for handling the reported cyber-attacks. The roles and responsibilities are divided into two groups:
  - i. **Cyber – strategy and governance:** The responsibilities under this group relates to the policy and decision-making aspects of cyber security framework
  - ii. **Cyber security – risk, operations and compliance:** This group comprises of responsibilities relating to the operational parts of implementing cyber security policies
- c) Standardization of security practices and abundant guidance from knowledge bodies while implementing security controls and processes. There are multiple global security standards and Indian standards that are relevant in context of underlying technologies used in smart meters:
  - i. National Institute of Standards and Technology (NIST) has developed a framework for Cyber Physical Systems (CPS). The Framework provides a taxonomy and organization of analysis that allow the complex process of studying, designing, and evolving CPS to be orderly and sufficiently encompassing.
  - ii. Department of Electronics and Information Technology (DeitY), Government of India has developed a National Cyber Security Policy. It aims at protecting the public and private infrastructure from cyber- attacks. The policy also intends to safeguard "information, such as personal information (of web users), financial and banking information and sovereign data".
- d) Cyber security incident management: The ISO/IEC Standard 27035 outlines a five-step process for security incident management, including:
  - i. Prepare for handling incidents.
  - ii. Identify potential security incidents through monitoring and report all incidents.
  - iii. Assess identified incidents to determine the appropriate next steps for mitigating the risk.
  - iv. Respond to the incident by containing, investigating, and resolving it
  - v. Learn and document key takeaways from every incident

Notwithstanding the measures suggested above, the following guidelines/strategies shall be taken care of by the AMISP for making the entire AMI system including the NOMC immune to Cyber Attacks.

- a) All the Hardware, OS and application software shall be hardened.
- b) Application, scanning and hardware scanning tools shall be provided to identify vulnerability & security threats.
- c) Data shall be encrypted at system/device/technology level.
- d) Network Zoning shall be implemented as per the proposed architecture. However, the AMISP may suggest other methods of network architecture without compromising the security of the System.
- e) Internal user shall be allowed to access all adjacent zones. However, they will not have access to remote network zone.
- f) While procuring cyber security items testing must be done and the system must be secure by design.
- g) Residual information risk shall be calculated by AMISP and same shall be submitted to the Utility for approval.
- h) All default user id & passwords shall be changed.
- i) All log in/out and cable plugs in/ out shall also be logged in Central Syslog server.

- j) Penetration & Vulnerability assessment test from CERT-IN certified auditors during SAT & Operations and Maintenance period.
- k) Auditing by third party during SAT and annually during operations and maintenance period shall be in the scope of AMISP.
- l) As the computer system in NOMC has access to external environment the AMISP shall document and implement Cyber Security Policy/Plan in association with the Utility to secure the system.
- m) Latest Cyber Security Guidelines issued by CERT-In specified at <http://www.cert-in.org.in/>, Ministry of Power (including “Testing of all equipment, components, and parts imported for use in the power Supply System and Network in the country to check for any kind of embedded malware /trojans/ cyber threat and for adherence to Indian Standards – Regarding” vide Order No. No.9/16/2016-Trans-Part(2) published by Ministry of Power, Government of India dated 18 November 2020 and amended from time to time) or any other competent authority shall be followed.
- n) AMISP shall adhere with the appropriate security algorithm for encryption and decryption as per established cyber security guidelines. For smooth functioning of the entire system, it is essential that the AMISP shall provide in the form of a document enough details of such algorithm including the mechanism of security key generation to the **MVVNL**. In case of proprietary or secret mechanism, the same shall be kept in a secured escrow account.

#### 2.7.8 Data Privacy

AMISP should describe ensure that the system is compliant with the applicable provisions of the “Reasonable security practices and procedures and sensitive personal data or information Rules, 2011 (IT Act)” as well as shall be committed to work with **MVVNL** for compliance to Personal Data Protection requirements. In this regard, the general elements of the data privacy framework may include:

- a) The **MVVNL** shall be the sole custodian of the Smart Meter data. The AMISP and its contracted vendors will have limited need basis access to the data. In case of pre-mature termination or at the end of contract, the AMISP and the contracted vendors should relinquish all access to the data and transfer the same to the **MVVNL**.
- b) AMISP is required to prepare and submit a “Privacy by Design” document to the **MVVNL** which details out all the policies, practices, processes and technologies employed to manage, and process the Smart Meter data in a secure manner. This should also include the details on methods of anonymization applied to the personal Smart Meter data based on data types defined below:
  - i. Aggregated Data: No identification individually and at neighborhood level unless explicitly required to report
  - ii. Anonymized Data: A data set which has individual Smart Meter data but without any personally identifiable information like consumer name, account number, address etc.
  - iii. Personal Data: A data set with Smart Meter data tagged with personally identifiable information.
- c) AMI system should enable the **MVVNL** to get the consumer consent on sharing and processing of Smart Meter data based on following criteria
  - i. Consumer consent not required
    - 1) If any type of Smart Meter data is processed by the **MVVNL** or a third party on behalf of **MVVNL** for the purpose of generating bills, identifying theft, network planning, load forecasting or any related activities that can enable the **MVVNL** to fulfil its duty as a licensee.



- 
- 2) If any type of Smart Meter data is requested by the law enforcement agencies.
  - 3) If aggregated or anonymized data is shared with not-for-profit academics, policy research, civil society entities for research that can benefit the sector in general.
- ii. Opt-out consumer consent
    - 1) If any type of smart meter data is shared with or processed by any third-party commercial entity to provide services other than as enabled by regulation. In this case, the AMI system should enable the **MVVNL** to conduct the following consumer consent process
      - Consumer should be notified and given a time to opt-out
      - Consumer should have the right to change his/her option through the app/web account/direct communication to **MVVNL**.
  - d) AMI system should enable following Data sharing protocol
    - i. Data should be shared by providing finite and secure access to the system. The access can be modified or terminated as need be.
    - ii. Sharing of part/full database shall be subject to review and consent of **MVVNL**.
  - e) All data sharing shall be recorded and periodically submitted to **MVVNL** for review / regulatory requirement
  - f) AMISP should have a data breach response plan and should communicate to the **MVVNL** and consumers in case of any data breach from AMI system
  - g) AMISP is responsible to conduct 3rd party data privacy audit at least once every year based on evaluation criteria pre-identified by the **MVVNL** in consultation with data experts. The audit report should be made available to **MVVNL**. AMISP to take necessary actions on audit observations in consultation with the **MVVNL**.

### 3. AMI System Integrations

The AMISP's core deliverables are the MDM, the HES, the NMS and the smart field devices (DCUs/Routers and Smart Meters). Hence the system integrations shall comprise of the following,

- i. HES with field devices (DCUs/Routers and smart Meters)
- ii. MDM with
  - a. HES
  - b. Billing and CIS
  - c. Other legacy IT/OT systems as required by the **MVVNL**
  - d. National level Reporting Platform to come up in future

#### 3.1 MDM Integrations with **MVVNL** IT/OT Systems

The MDM will act as the bridge to integrate the AMI system with other **MVVNL** IT/OT systems. These IT/OT systems may be already existing or those which the **MVVNL** have planned. The IT/OT systems may include but not be limited to the following:

- a) Billing, CIS, IVRS, CRM systems
- b) Legacy Data Collection Systems
- c) HHU/CMRI or manual reading system etc.
- d) Consumer Portal/ App
- e) GIS
- f) SCADA, OMS
- g) PLM, DRMS
- h) Asset Management System
- i) Work Force Management System
- j) DT Monitoring System
- k) EVSE

The details of the existing integration infrastructure, including specificity in implementation, interface and services available for each of the existing enterprise applications which the AMISP has to integrate with the AMI system, has been provided in Annexure L of this Section.

For those IT/OT systems which the **MVVNL** have planned in future, the AMISP shall publish document on available standard interfaces to enable their integration.

It will be necessary to integrate the MDM with the **MVVNL** IT/OT systems following robust industry standard mechanisms.

MDM shall interface with these IT/OT systems on standard interfaces. The data exchange models and interfaces shall comply with CIM-XML-IEC 61968-9 / IEC 61968-100 / Web Services / MultiSpeak v3.0. MDM solution shall be ESB-SOA enabled.

The aim of the above interface standards is to ensure generic two-way interfacing of the MDM with other applications. This effort shall be guided by the methodology whose details are outlined in the approach paper set out in Project Implementation Plan.

### 3.2 HES Integrations with Field Devices

HES shall export all meter data to MDM and pass control commands from MDM. HES should conform to IEC 61968-9 as well as support CIM 2.0 / MultiSpeak v3.0 standards. It may use any other standard interfaces as outlined in the approach paper, submitted as part of project implementation plan, for integrating with the MDM. In case, **MVVNL** has implemented any Service Oriented Architecture (SOA)/ Enterprise Service Bus (ESB) architecture, the data exchange to and from HES shall be through this ESB. The details of its ESB in the templated provided in Annexure G.

The HES shall follow the integration protocol established by IS 15959 (DLMS-COSEM) and make use of ACSE and xDLMS services to communicate with southbound field devices (DCUs and Smart Meters) irrespective of the physical communication layer.

### 3.3 Integrated Network Management System

The Network Management function specific to the HES shall be integrated with overall Data Centre level NMS module for easy monitoring, analysis and reporting

### 3.4 Integration with national level reporting platform

The AMI system put in place should provide a seamless exchange of data with a national level data portal without any manual interface including NFMS. In this regard, the MDM shall have an out-bound interface to facilitate data transfer through API-based model/ service bus to a central platform as and when made available. An indicative data list will be provided by the **MVVNL** for sharing with the national level reporting platform during contract period. The technical interface (such as web services, published APIs, DB table schemas etc.) for enabling this integration, will be defined accordingly. However, the AMISP needs to ensure the following:

- a) Any reports / analytics / graphics from system would provide opportunity to anonymize/ remove traceability to individual consumers to maintain privacy
- b) Reports/data made available in the public domain for public consumption should be always sufficiently aggregated/ anonymized so as to protect consumer privacy.

## 4. Consumer Indexing

Consumer indexing will be carried out/verified for the incoming population of smart meters for end-to-end metering at contiguous electrical locations in the selected AMI Project Area only. The responsibility for consumer indexing for dispersed metering at non-contiguous electrical locations in the selected AMI Project Area shall lie with the **MVVNL**. For this a door-to-door survey shall be required for each meter installed and tallying it with the consumer related records (physical, electrical and commercial) available with the **MVVNL**. In establishing the linkage of the consumer meter to the electric network, the asset (including the meter) codification as used by the **MVVNL** GIS (or as per standards set by the **MVVNL**) shall be strictly followed. If the GIS asset database is available, the verified consumer data shall be uploaded into the GIS database by the **MVVNL** for a single point of truth, presentation and secondary evaluation. If GIS is not available, then the AMISP is required to create a standalone consumer indexing database. This database of electrical indexing shall have the following broad parameters:

- Energy Meter name plate details
- Meter clustering if any
- Sealing Status
- Installation Date
- Start Reading (New Meter) and Last Reading (Old Meter)
- Geo Location
- Customer Name
- Username
- Postal Address / Telephone / Email
- Sanctioned Load
- Pole/DT/Feeder Code

Either of the following checks may be done to establish the correctness of the indexing database. The selection of these methods or any other equivalent method shall be at the sole discretion of the AMISP vendor.

1. Correlation of DT wise energy loss with load flow studies; or
2. Selective demand trip of DT to identify meters under outage

### 4.1 Scope of Work for CI

- a. Obtaining details of existing consumer indexing available with the **MVVNL** as a starting reference point.
- b. Capturing of all the mandatory attributes mentioned in the CI format.
- c. Updation of consumer details within the geographical boundary covered by the **MVVNL** as part of the scope. The details of new/shifted consumers shall be provided by the **MVVNL**.
- d. Consumer indexing for added/shifted consumers based on the ledger/field survey with physical verification of the existing consumer database. Modification/correction of consumers based on electrical system with the help of **MVVNL**.
- e. Capturing of complete attributes of the consumers; viz, consumer code present in **MVVNL** legacy system, consumer name, address, mobile number, asset id of source of power supply, service type (poles, feeder/pillar box, OH/UG), meter make, meter location, meter serial number etc.
- f. Capturing of GPS co-ordinates (Latitude/Longitude) of consumer premises through the Mobile Application (developed by Implementing Agency) which must have facility of

- capturing Latitude/Longitude. During the CI, Field Team must click on the location and Mobile App must automatically take the Latitude/Longitude of the consumer premises.
- g. Carrying out QA/QC on the collected consumer data.
  - h. Submission of data of the consumers in computerized file to the **MVVNL**. The file shall have the facility to edit, update and create data. Further, (2) hard copies of the deliverables, for approvals/comments by the concerned officer(s), shall also be submitted by the implementation agency.
  - i. Getting the CI data verified/validated by the concerned Officers/Authorities. The implementation agency is expected to obtain approval from Competent Authority. The implementation agency shall obtain the acceptance/take over certificate by the concerned Officers/Authorities.
  - j. Surveyor/Field Team shall walk along with the line and identify the consumers to whom supply is released from each pole / service pillar and identify the Distribution Transformer from where each Consumer is fed.
  - k. For the purpose of data validation and quality check, the sample size would be 10% of the total consumers under the assignment. The error toleration level shall be 5% of the sample size.
  - l. In case of comments by the concerned Officers/Authorities, the same would be incorporated and resubmitted by the SI. It will be the responsibility of the SI to ensure that Consumer data collected does not become stale during the course of the execution of the project.

After meter installation, details of consumer connections, such as consumer identification no., meter ID, its hardware & software configuration, name plate details, make, type i.e. 1 Phase or 3 Phase shall be automatically updated in the AMI system. The information would also be updated on the consumer portal and app for providing information to consumers.

**4.2 Consumer Indexing & Meter Installation APP:** Consumer Indexing & Meter Installation should be carried out through a robust CI/MI Application for better tracking and record of field activities.

**Consumer Indexing (CI):** Site Survey of electrical device and conduct door to door survey to obtain consumer details by consumer indexing (CI), we can find Division/sub division wise location of the consumer through which feeder, or transformer, or circuit number and or pole consumer is being supplied. Mobile App should have functionality of capturing the asset condition, Meter Condition , Meter Height , Meter Location (Inside/outside) , Cable Type (un-armoured /armoured) , Consumer Connection Status ( Active /IDF /TD /PD), Others ( Consumer Denial /Door Locked) and other required information through automated tool or manual screens, most important Longitude & Latitude (auto-populated) of location using Google map.

**Meter Installation (MI):** Smart meter installation on the premises as per order received from organization. Meter installation is the process where Implementing Agency needs to install smart meter physically on the consumer premises based on the order finalized. There may be different

scenarios i.e. New Service connection, old meter change, smart meter to smart meter change, Net meter, IDF, Load Enhancement etc. The provision to capture the details against each case as mentioned above to be provided in the application for paperless activity and the consumer/ old meter information/new information data should be seamlessly updated to the AMI/MVVNL System.

**Inventory Management:** Inventory Management is to have readily availability of stock. All inventory of Meters devices and its accessories are maintained in warehouse and system will provide the actual inventory status of all devices. This system would be real-time or offline integrated with meter installation system or other system. Selection of Meter or Asset from Inventory for installation, meter or device will be automatically deduct the balance of asset from the inventory. In case of Smart Meter to Smart Meter replacement, inventory will be added as defective and as well as deducted from the inventory management with meter status (in case of faulty) with a maker and checker concept.

AMI Implementing Agency shall maintain the inventory of all the meters in designated warehouse, maintenance and security including full responsibility for protection from theft and fire. Meter Inventory Management and Warehousing to be maintained by AMI Implementing Partner on real-time basis.

### **Mobile application for Consumer Information, Meter Installation & Meter Advising (MC)**

During consumer indexing and meter installation implementation agency will use android/iOS based mobile application. Consequently, following are the major scope of work for installation in the field.

- Consumer Indexing team (for capturing consumer's information)
- Documentation and Approval of prescribed format for Consumer indexing & Smart Meter installation and sealing information.
- Resource deployment and Responsibility allocation
- Quality and Safety Assurance during field work

## **5. Consumer Engagement**

- 5.1 AMISP shall develop a consumer engagement plan for smooth implementation of AMI system. The plan at the minimum should include consumer engagement activities to be undertaken at MVVNL's headquarter, division and sub-division level as well as communication and media plan for the same. The plan should include educating consumers about the pre-paid recharge mechanism, benefits of pre-paid meters, potential usage of Smart Meters data for consumers, etc;
- 5.2 MVVNL shall provide necessary inputs for developing a comprehensive consumer engagement plan;
- 5.3 The MVVNL shall implement consumer engagement plan with support of AMISP. This would include running media campaign to raise awareness and counter myths around smart metering prior to installation, etc.

---

## 6. Analytics and Reports

### 6.1 Analytics including Energy Audit

The MDM shall have analysis capability based on configurable business rules including but not limited to the following:

- a) **Energy Audit:** Perform DT/Feeder/ Sub-Division/ Division/ Circle wise energy audit for configurable period. These energy audit reports shall clearly bring out the technical and commercial losses through detailed analysis of supply side energy data and corresponding aggregated consumption data of connected consumers. In this analysis it must factor in data of energy export from net-metered consumers. The automated audit should include but not limited to:
  - I. A daily automatic feeder loss (Feeder Head reading minus summation of all DT meters readings)
  - II. Automatic LT Energy loss (DT meter reading minus summation of readings of all those consumer meters served by the selected DT) would be reported
  - III. Billing and collection efficiency
  - IV. Identify the top [X] best as well as worst performing feeders and DTs
- b) Display consumption/load profiles by configurable period (15/30 min, hour, day, month, year etc.) day type (weekday, weekend, holiday, festival wise etc.) and by tariff, consumer type (hospitals, schools, govt. offices, multiplexes, commercial, residential, industrial etc.), or any user specified collection of meters.
- c) Generate peak & off-peak load patterns by aggregating all loads of consumer group/consumer type/DT/Feeder over configurable period/day type.
- d) Perform load analysis for different groups and categories of consumers in different weather conditions.
- e) Ability to provide the data to load forecasting, load research or demand response applications (based on use cases provided in Annexure H) and perform error management such as missed reads and intermittent meter reads before sharing data with load forecasting, load research or demand response
- f) Ability to configure the system to effectively visualize consumption trends, identify unusual patterns, and visualize load analysis to understand which assets are being over utilized.
- g) Analysing data to identify new patterns of usage, Setting fraud alert / transformer overload alerts / demand – supply gap alert etc.
- h) Ability to receive and store outage and restoration event data from Smart Meters and outage systems and to log all such events for analysis and also support calculation of compensation payments for sustained outages. Five reliability indices shall be calculated,
  - i. System Average Interruption Duration Index (SAIDI), which is sum of all consumer interruption durations in a given period over total number of consumers served.
  - ii. System Average Interruption Frequency Index (SAIFI), which is the total number of sustained interruptions in a given period over total number of consumers served.

- iii. Consumer Average Interruption Duration Index (CAIDI), which is sum of all consumer interruption durations in a given period over the total number of sustained interruptions in that given period
- iv. Consumer Average Interruption Frequency Index (CAIFI), which is the total number of sustained interruptions in a given period over the total number of distinct consumers interrupted in that given period
- v. Momentary Average Interruption Frequency Index (MAIFI), which is the total number of consumer interruptions less than the defined time (1 or 5 minutes) over the total number of consumers served

These reliability indices shall be calculated for each month, for individual feeders and aggregated annually for the whole **MVVNL**. The source data for outage shall be last gasp / first breath messages from DT/Feeder level meters or the power outage/restoration events logged by these meters. These computations shall be independent of similar computations made by any OMS application.

- i) Ability to alerts on DT/ Feeder level overvoltage & back-to normal event and under-voltage and back-to-normal events. Based on these alerts the system should calculate the duration in which the DT/Feeder remained outside the nominal zone of defined voltage. Similar calculations should be allowed for power factor and current unbalance.
- j) Identify & visualize poor performing assets such as feeder/DT on multiple criteria such as energy losses, outage duration etc. through appropriate colour coding depending on severity thresholds.
- k) Analyse data of net-metering consumers to identify patterns of energy export to grid on hourly/weekly/monthly/yearly basis.

## 6.2 Reporting Function

The Report function shall enable the **MVVNL** to deliver reports in standard digital format such as PDF, Excel, etc. All queries for report generation shall be made through user driven drop down menu through GUI of **MVVNL** user interface (refer to Clause 2.5.1 of this Section for more details). The AMISP shall provide example queries to support internal report generation needs. The GUI shall have provisions to set up or change report delivery to configurable email addresses, network file directories, ftp sites or printer systems without modifying source program code and without any proprietary language skills.

- 6.2.1 The MDM shall generate following reports (an indicative list only). **MVVNL** may request for additional reports as well during the contract period.
  - i. Daily data collection report
  - ii. Usage exceptions
  - iii. VEE validation failures
  - iv. Missing interval Read date and times (on hourly, daily, weekly & monthly basis) and their trends
  - v. Physical meter events (install, remove, connect, disconnect) & meter reset report
  - vi. Meter flags
  - vii. Meter inventory
  - viii. Defective meters



- ix. AMI performance measurements
- x. Threshold exception
- xi. DT condition monitoring
- xii. MIS reports and analytical reports including but not limited to following:
  - 1) Payment collection summary and details in a day/week/month/year or as per user selectable period and trends
  - 2) Number / list of disconnected consumers due to inadequate prepaid account balance
  - 3) Prepaid consumers running low on account balance
  - 4) Connected consumers
  - 5) Critical notifications sent to consumers
  - 6) Revenue analytics as per consumption pattern of consumers (in terms of money and energy units). This shall also include automatic compensation payments by **MVVNL** to consumers for sustained outages, if implemented
  - 7) Data-driven Analytics reports by leveraging AI/ML based technologies

~~6.2.2~~ Following high level reports for **MVVNL** Management shall be generated automatically at specified frequencies to help management with business decisions. *<Below is an example of reports<sup>5</sup> that may be generated. These reports should be defined and agreed by the **MVVNL**>*

Category	Report	Frequency
Energy Audit	Energy Audit Report (DT/ Feeder / Sub-Division/ Division/ Circle wise) in contiguous electrical locations: <ul style="list-style-type: none"> <li>• A daily automatic feeder loss report (Feeder Head reading minus summation of all DT meters readings)</li> <li>• Automatic LT Energy loss report (DT meter reading minus summation of readings of all those consumer meters served by the selected DT) would be reported</li> <li>• Billing and collection efficiency</li> <li>• Identify the top [X] best as well as worst performing feeders and DTs</li> </ul>	Daily, Monthly and User Selectable Time Period with configurable near real time alerts for exceeding defined loss threshold
Reliability Indices	SAIFI and SAIDI; CAIFI and CAIDI; MAIFI of the feeder(s) and connected consumers would be tracked to measure the improvement in the same overtime and establishing reference levels	Daily, Monthly and User Selectable Time Period
Load Management	DT Loading (Categorize DT as overloaded, optimally loaded, near optimal, under loaded)	Daily, Monthly and User Selectable Time Period with configurable near real time alerts

<sup>5</sup> These reports shall be generated provided the corresponding DT/ Feeder data is available as part of the AMI system being installed.

Category	Report	Frequency
	Load recording (Consumers): Actual consumption recorded higher than the sanctioned load identifying the top [X] consumers	Daily, Monthly and User Selectable Time Period with configurable near real time alerts
	Load Management Report (Identify top overloaded DTs) and load rise trend	Monthly and User Selectable Time Period
POWER QUALITY	Voltage Deviation Index and Frequency Deviation Index (DT/ Feeder)	Daily, Monthly and User Selectable Time Period with configurable near real time alerts
	Low Power Factor (DT/ Feeder)	Daily, Monthly and User Selectable Time Period with configurable near real time alerts
	Meter Current Unbalance (DT/ Feeder)	Daily, Monthly and User Selectable Time Period with configurable near real time alerts
Loss Analytics	Tamper Alert: as per IS 15959 Part 2	Daily, Monthly and User Selectable Time Period with configurable near real time alerts
	Comparison Consumption (system used to detect & track theft suspects)	
	Consumption lower than the expected pattern (pattern of previous year applied to the monthly average) or monthly average	
Management Summary Report (Dashboards)	Summary report on top [X] high loss DTs/ Feeders, top overloaded DTs/ Feeders, Top feeders/ DTs with most outages (number and duration), Top feeders with most power quality issues (over voltage, under voltage, current unbalance, out of band frequency), DTs with high failure rate	<Monthly and User Selectable Time Period>

- 6.2.3 The **MVVNL** interface should have ability to generate reports on critical and non-critical information received from the HES to the MDM as per Clause 2.3.3 of this Section.
- 6.2.4 The **MVVNL** interface shall have feature to generate report related to SLAs being mentioned in Clause 7.7 of this Section.
- 6.2.5 Ability to generate various analytics reports as per Clause 6.1 of this Section.
- 6.2.6 AMISP shall submit a detailed report on data being shared as per Clause 2.7.8 on a yearly basis. AMISP shall submit detailed report on any exception in general data sharing on monthly basis. Further, AMISP shall also submit a detailed report for any other time period as requested by **MVVNL**



## 7. Operation and Maintenance

### 7.1 Scope and period

The operation, maintenance, and support services start after the successful completion of the operational go-live of the system as per Clause 9.6 of this Section. Operation, maintenance and support services shall extend up to end of Total Meter-months from Operational Go-Live. The scope of work under operation and maintenance services shall include,

- a) Comprehensive maintenance of all the software (including licensing, version upgrades if any and annual technical support cost)
- b) Comprehensive maintenance of all hardware at the Operation and Monitoring Centre, along with field devices (like Smart Meters, DCUs etc.) provided by AMISP under the project
- c) Comprehensive maintenance of all equipment under leased service like cloud data centre, MPLS band width etc.
- d) Comprehensive maintenance of NAN / WAN communication infra between field devices and the cloud data centre
- e) Day to day operations of the AMI system under supervision and authority of the **MVVNL**. These shall include among others,
  - i. New meter installation
  - ii. Changeover of consumer meters from post-paid to prepaid mode and vice versa
  - iii. Firmware update of remote devices (Meters and DCUs) as required
  - iv. Update of tariff slabs
  - v. Ensuring completion of recharge cycle of prepaid consumer meters
  - vi. Connecting, disconnecting or reducing consumer's licensed load under approval from the **MVVNL**.
  - vii. Initiating resolution of consumer trouble tickets raised by **MVVNL** CCS
  - viii. Ensuring availability of BP, LP, interval data and event notifications from meters in time schedules as agreed with the **MVVNL**
  - ix. Ensuring scheduled completion of billing determinant calculations
  - x. Ensuring daily reports from the AMI system as per agreed list, are made available to **MVVNL**.
  - xi. Ensuring Consumer Portal is kept updated
  - xii. Ensuring smooth data traffic between the MDM and **MVVNL** systems
  - xiii. Patch management of AMI applications at cloud data centre
  - xiv. Provide backup data to support SLA and AMISP invoicing
  - xv. Carry out performance checks of various functions as per agreed schedule or on demand

As part of their Operation and Maintenance responsibilities, the AMISP shall develop a compendium of Operation and Maintenance Manuals covering the areas mentioned in serial number e), Clause 7.1 of this Section. These manuals shall be kept updated as often as necessary to reflect best practices being employed in the project.

The AMISP is to hand hold the **MVVNL** team to take over operation, maintenance and support services after completion of contract period. The project/ system devices should allow their functionalities to be upgraded without disruption to the existing functionalities by downloading new software and configuration information.

## 7.2 AMISP's Responsibilities under Operation & Maintenance Services

The AMISP shall make available the following man-power resources at the MVVNL's Network Operations cum Monitoring Centre,

- a) One resident Project Manager cum Supervisor,
- b) [Three] numbers operations staff
- c) [One] support engineer for each category of hardware supplied and
- d) [One] software specialists for each domain.

The above-mentioned operation and support staff shall be made available as required to meet the SLA and system availability requirements. Re-distribution of any support engineer/specialist at the cloud Data Centre shall be at the discretion of the AMISP.

It shall be the responsibility of the AMISP to collect meter data through handheld meter reading instruments for the balance meter data reads not fulfilled by the automated remote reading process. Similarly, if the remote connect / disconnect facility fails, it shall be the AMISP's responsibility to manage the function locally.

## 7.3 Maintenance Practices

For all third-party equipment (Hardware & Software) AMISP shall have back-to-back support along with supply of spare with appropriate response time from OEM/OEM Authorized representatives. AMISP shall be responsible for coordination with the OEM for all matter related to equipment. The maintenance practice followed by AMISP shall be in accordance with best industry practices and must include the following:

- a) Scheduled preventive maintenance, performance monitoring, system backup, hardware & software maintenance and update, field & network devices firmware update, emergency response and troubleshooting etc.
- b) Maintaining adequate spares for maintenance.

### 7.3.1 Preventative Maintenance Activity

The preventive maintenance activities shall be performed by the AMISP to keep the system running at optimum level by diagnosis and rectification of all hardware and software failures and would broadly include:

- a) Repair / replacement of defective equipment
- b) Configuration of the replaced hardware and software, periodic routine checking as part of a preventive maintenance program
- c) Monitoring of the performance of the system and doing necessary tuning for optimum performance to accommodate any changes such as addition of new components
- d) Providing all necessary assistance to the MVVNL for addition and modification of MVVNL user interface, consumer Portal/ App displays, and Database
- e) Ensure Backup of the system at regular interval which is mutually decided during system design
- f) Restoration of the systems upon its failure and to restore the functioning of the various application / systems at the cloud data centre. Towards this, the RPO and RTO shall have to be measured no less than once a month.

### 7.3.2 Integration of Equipment

All future services, protocol emulations and configuration support for integration of Smart Meters/ nodes, routers, access points, network devices, web services, integration with other offline applications etc. shall be the responsibility of AMISP and shall be part of the maintenance activities.

### 7.3.3 Spares inventory

As part of project implementation plan, the AMISP shall detail the spares inventory that shall be maintained for the AMI Project. These spares shall be used as and when required by the AMISP for the project and no separate charges shall be payable. The AMISP shall decide the items and components to be maintained as spare

## 7.4 Monitoring

The operation and performance of the various systems shall be monitored on a continuous basis. The AMISP shall conduct at least the following monitoring:

- a) MDM / HES system error history logs or selected day
- b) Field & Network device failure – rate and trends
- c) Availability of various communication links
- d) Missing meter data – rate and trend
- e) Reviewing resource information
- f) Cyber Security

During monitoring if any defect/ abnormality is found, the AMISP shall undertake corrective maintenance for the same. The MVVNL's UI shall be kept updated with a summary of such monitored data

### 7.4.1 System Cyber Security Monitoring

The AMISP shall also be responsible for monitoring of the system from cyber security perspective. The logs of the system shall be analysed for exceptions and the possible incident of intrusion/trespass shall be informed to the MVVNL and analysed to discover root cause. The monitoring shall encompass all cyber security devices installed at the cloud data centre as well as at the NOMC such as firewalls, all types of Intrusion prevention system, routers etc.

The Cyber security system shall also be subjected to Annual Security Audit from CERT-In listed auditors at the cost of the AMISP during the contract period. AMISP shall share with MVVNL such audit reports and implement the recommendations/remedial actions suggested by the Auditor.

## 7.5 Meter Accuracy Tests

In case a Consumer complains about meter accuracy post operational go-live and same isn't reasonably resolved through past consumption trend, Transformer Energy Audit, Check Meter (by MVVNL), etc. AMISP will be obliged to facilitate the meter testing. In this regard, AMISP shall handover the meter for testing to CPRI Lab/ MVVNL Lab/ NABL accredited Lab and install a temporary meter till the period of removal and replacing meter, if found inaccurate or reinstall if found accurate.

## 7.6 Physical Maintenance

The AMISP shall undertake physical maintenance of all equipment/modules under the scope of this contract, in accordance with the schedule as indicated by AMISP in project implementation plan. The

physical maintenance shall include cleaning, dusting, inspection of equipment for loose connections, damage to insulation, pest infections etc. Equipment shutdown during preventive maintenance shall be deemed as available.

### 7.7 Service Level Agreement (SLA)

Service Level Agreement (SLA) shall be monitored as mentioned in the following table. It is expected that the AMI system shall meet the minimum threshold of service defined against each lever. Any degradation below this minimum threshold will attract penalties as per bands of service level met. The idea is that it triggers a proper review of any defect / failure / performance that had been agreed upon for the project, and to find resolutions in keeping with the highest standards of service excellence. The total penalties under SLA categories are capped at [20%] of AMISP Service Charge. AMISP shall ensure that the data collection and computation for the purpose of SLA penalties (as mentioned in the following table) should be automated and visualized in **MVVNL** Interface as per Clause 2.5 of this Section.

For this purpose, each of the designated scheduled tasks in the following table, shall signal<sup>6</sup> the SLA computation application to record the start time. The same designated tasks shall generate mile-stone signals<sup>7</sup> in order that the SLA application is able to record times when various thresholds (as indicated in the table) of meter population have responded. For system level availability, the SLA computation application shall offer a ticketing system which shall be used by the **MVVNL** &/or AMISP to raise an incident against any line item at corresponding severity level. The incident originator shall select the severity level followed by selecting the incident description (as per Annexure J) available as a drop-down list within the SLA application. The ticketing system shall follow a process flow such that,

- a) The AMISP's response along with time of response are recorded. This 'response' may be a simple acknowledgement of the incident or a rejection of the incident as not being part of its 'scope of work' with adequate explanation.
- b) **MVVNL**'s acknowledgement or rejection of AMISP 'response' along with time are recorded. If **MVVNL** acknowledges the incident to be irrelevant to AMISP's scope of work, then the incident is immediately closed, and no further records are maintained for this incident<sup>8</sup>.
- c) Resolution &/or workarounds are recorded and submitted by AMISP along with time
- d) In case of enhancements and change requests, AMISP's Plan of Action (POA) and schedule are recorded
- e) AMISP's POA and schedule (for enhancements and change requests) are approved by **MVVNL**
- f) Resolution as submitted by AMSIP is approved by **MVVNL** and the incident closed. In case of rejection of resolution, the incident shall remain live and shall have to be re-worked by the AMISP.
- g) All submittals, acknowledgements, approvals/agreements shall have system generated time stamps by default. There shall be also provision for a separate manual entry of time stamps.

<sup>6</sup> This signal shall be always automated, and the SLA Application would know precise number of meters involved.

<sup>7</sup> Alternate provision may be kept for manual entry of time for such mile-stone signals but with proper backup monitoring report made available.

<sup>8</sup> The first two process steps in the ticketing system of the SLA App shall ensure complete agreement between **MVVNL** and AMSIP, before an incident is accepted for resolution.

Data Type	Performance Requirement (Averaged over a month) <sup>9</sup>	Penalty	SLA Penalty Calculation (For understanding purpose only)
<b>A. Scheduled Tasks</b>			
<b>1. Scheduled Interval data readings</b>			
Periodic collection of the interval load profile data for the day <sup>10</sup>	From 95% of meters within 8 hours	Deduction of 0.2% of AMISP Service Charge for every 1% or part there of capped at 1% penalty	Maximum Penalty of 1% if action takes place for <91% of meters
<b>2. Scheduled Interval data readings</b>			
Periodic collection of the interval load profile data for the day <sup>11</sup>	From 98% of meters within 12 hours	Deduction of 0.2% of AMISP Service Charge for every 1% or part there of capped at 1% penalty	Maximum Penalty of 1% if action takes place for <94% of meters
<b>3. Scheduled daily meter readings</b>			
Previous days <sup>12</sup> interval energy and total accumulated energy	From 99.5% of meters within 24 hours after midnight	Deduction of 0.2% of AMISP Service Charge for every 1% or part there of capped at 2% penalty	Maximum Penalty of 2% if action takes place for <90.5% of meters
<b>4. Scheduled billing profile data for the bill period</b>			
Collection of billing data for the bill period	From 99.5% of meters within 72 hours of the scheduled periodic collection/ end of the billing period and From remaining 0.5% of meters within 168 hours of the scheduled periodic collection/ end of the billing period. Please refer to Annexure K for the billing schedule	Deduction of 0.5% of AMISP Service Charge for every 0.5% or part there of capped at 3% penalty	Maximum Penalty of 3% if action takes place for <97.5% of meters
<b>5. Scheduled energy audit and reliability indices report<sup>13</sup> (DT wise)</b>			

<sup>9</sup> Local intervention allowed to achieve SLAs

<sup>10</sup> Assuming interval of 30 minutes. <In case, MVVNL aims to change the interval, accordingly the performance requirement may need to be changed>

<sup>11</sup> Assuming interval of 30 minutes. <In case, MVVNL aims to change the interval, accordingly the performance requirement may need to be changed>

<sup>12</sup> All previous days from the last billing cycle

<sup>13</sup> As defined in Clause 6 of this Section. Unless both energy audit and reliability indices report (DT wise) are generated at scheduled periodic interval, AMISP shall be considered non-compliant to the defined SLA and shall be liable to penalties.



Data Type	Performance Requirement (Averaged over a month) <sup>9</sup>	Penalty	SLA Penalty Calculation (For understanding purpose only)
Generation of monthly energy audit and reliability indices report	From 100% of DT installed meters within 384 hours (16 days)	Deduction of 0.1875% of AMISP Service Charge for every 1% or part there of capped at 1.5% penalty	Maximum Penalty of 1.5% if action takes place for <93% of meters
<b>6. Scheduled energy audit and reliability indices report<sup>14</sup> (Feeder wise)</b>			
Generation of monthly energy audit and reliability indices report	From 100% of installed Feeder meters within 384 hours (16 days)	Deduction of 0.25% of AMISP Service Charge for every 0.5% or part there of capped at 1.5% penalty	Maximum Penalty of 1.5% if action takes place for <97.5% of meters
<b>B. Remote Actions / tasks performed by AMI System</b>			
<b>7. For remote connect/disconnect with acknowledgement/ response for selected meters</b>			
Remote connect / disconnect of the AMI meters	Action performed at 90% of meters within 15 minutes	Deduction of 0.5% of AMISP Service Charge for every 0.5% or part there of capped at 2.0% penalty	Maximum Penalty of 2.0% if within 15 minutes, delivery takes place for <88.5% of meters
<b>8. For remote connect/disconnect with acknowledgement/ response for selected meters</b>			
Remote connect / disconnect of the AMI meters	Action performed 99.5% of meters within 6 hours	Deduction of 0.25% of AMISP Service Charge for every 0.5% or part there of capped at 1.0% penalty	Maximum Penalty of 1.0% if within 6 hours, delivery takes place for <98% of meters
<b>9. Remotely top-up amount (for pre-paid application only)</b>			
Delivery of top up amount/ credit recharge in case of prepayment post successful transaction from payment gateway up to consumer interface <sup>15</sup>	99.9% meters within 30 minutes (delivered and intimated to consumer)	Deduction of 0.5% of AMISP Service Charge for delay of every 0.5% or part there of capped at 3.0% penalty	Maximum Penalty of 3.0% if within 30 minutes, delivery takes place for <97.4% of meters
<b>C. System Availability</b>			
<b>10. Availability of AMI System per month</b>			
Availability of AMI System per month	≥99.5%	Deduction of 0.4% of AMISP Service Charge for	Maximum penalty of 4% shall be deducted when

<sup>14</sup> As defined in Clause 6 of this Section. Unless both energy audit and reliability indices report (Feeder wise) are generated at scheduled periodic interval, AMISP shall be considered non-compliant to the defined SLA and shall be liable to penalties.

<sup>15</sup> Delay in delivery of credit recharge information to payment gateway or **MVVNL** Billing System excluded from the SLA measurement

Data Type	Performance Requirement (Averaged over a month) <sup>9</sup>	Penalty	SLA Penalty Calculation (For understanding purpose only)
		every 0.5% or part there of reduction in availability capped at 4.0% penalty	system availability is <95.0%

**Notes:**

1. Maximum Penalty out of the above shall be restricted at 20% of AMISP Service Charge. The deduction shall be computed as AMISP Service Charge X penalty % as computed in above table
2. The penalty, as mentioned above, shall be computed as per the performance deviated from the performance requirement. For instance, for SLA “Periodic collection of the interval load profile data for the day”, if within 8 hours, data is received from only 94.6% meters which means deviation of 0.4%, then the penalty shall be computed as  $\left(\frac{\max(0.4\%,1\%)}{1\%} \times 0.1\%\right) = 0.1\%$ .
3. Averaged over a month means weighted average performance from meter population over a predefined time interval. For instance,
  - a. Assuming on  $i^{\text{th}}$  day or event, action was done on  $y_i\%$  of total meters and within stipulated time, data was received from  $z_i\%$  of  $y_i\%$  meters. So, the average SLA over the month shall be computed as  $\frac{\sum z_i \times y_i}{\sum y_i}$
  - b. For system availability, the availability is computed as  $\frac{\text{THM} - (S1 \times 1 + S2 \times 0.8 + S3 \times 0.5)}{\text{THM}}$ ; Where THM is total hours in the month when power supply to AMI system is available, S1/S2/S3 is the total non-available hours in Severity Level-1/Level-2/ Level-3. Please refer to Annexure-I for more details on the same.
4. AMISP shall submit AMI generated reports for cases mentioned above based on data available in HES/MDM
5. Exclusions: Power Outages, Meter bypass by consumers, Local Temporary/ Permanent disconnection by Utilities, Meter burnt shall be excluded from above SLA calculations. For these cases, joint visit of AMISP and **MVVNL** officials shall be carried out and field inspection report shall be submitted by AMISP to **MVVNL** for suitable action.
6. For the purpose of joint visit, AMISP shall put a request to **MVVNL** who should allocate manpower for joint visit within 1 working day. In case of non-allocation/ non-availability of manpower from **MVVNL**, the report submitted by AMISP shall be final and actionable by **MVVNL**.
7. The penalties would be computed on the basis of performance of AMISP for a calendar month.
8. AMISP shall be responsible for collection of billing data for all Smart Meters within a week of the scheduled periodic collection/ end of the billing period.

## 7.8 Duties of MVVNL and AMISP during Operations and Maintenance Phase

The table in this section provides a summary definition of the roles and responsibilities of the AMISP and the MVVNL during operation and maintenance phase of the AMI Project.

Legend:

- This indicates who has primary responsibility to perform this function
- A: This indicates who will provide assistance
- F: Feedback

Item	Task	MVVNL	AMISP
<b>1.0</b>	<b>Problem Identification</b>		
1.1	Root cause analysis to determine whether the fault is attributable to Hardware or Software.	F	•
1.2	Resolution of problems involving third party maintainer where there is uncertainty whether the root cause is hardware or software.	A	•
<b>2.0</b>	<b>Software Problem Resolution</b>		
2.1	Report problem and assist with problem identification	F	•
2.2	Provide or recommend corrections, temporary patches, workarounds or other fixes to system problems	F	•
2.3	Install and test corrections, temporary patches, workarounds or other fixes to system problems	F	•
<b>3.0</b>	<b>Routine Software (including MDM, HES, MVVNL Interface, Consumer app/portal) Support</b>		
3.1	Build and maintain database, displays and reports	F	•
3.2	Perform system back-ups	F	•
3.3	Restore or reinstall software from back-ups	F	•
3.4	Monitor system logs (part of remote monitoring service)	F	•
3.5	Maintain system logs	F	•
3.6	Maintain user accounts	A	•
<b>4.0</b>	<b>Hardware (including meter, DCUs, routers, network operation and monitoring center etc.) Problem Resolution</b>		
4.1	Report problem and assist with defining problem	A	•
4.2	Troubleshoot problem to diagnose if it is software- related or hardware-related	F	•
4.3	Identify failed component, replace failed components in the system using parts from spares inventory	F	•

Item	Task	MVVNL	AMISP
4.4	Restore operation of repaired/replaced equipment	A	•
<b>5.0</b>	<b>Hardware Spare Parts</b>		
5.1	Manage local spares inventory	F	•
5.2	Replenish local spares inventory	F	•
<b>6.0</b>	<b>Integration and Database Work at NOMC End</b>		
6.1	Field Device Integration	A	•
6.2	Other System Integration	A	•
<b>7.0</b>	<b>Cyber Security Monitoring</b>		
7.1	Patch Updates	F	•
7.2	Cyber Security Monitoring	F	•
7.3	Annual Audits	F	•
7.4	Implementation of Recommendations during Audit	F	•
<b>8.</b>	<b>Manual Meter Read Through HHU In Case of Non-Communication of Smart Meters</b>	A	•

## 8. Training Requirements

### 8.1 Training Categories

The AMISP is required to organize following categories of training for the **MVVNL** personnel:

- a) **Professional Training** - This is the training for the core group of implementation team of the **MVVNL**. This team will comprise of members from all the Business Functions and IT sections. Each member would be trained in the relevant function/module. This Training would be required to be given to approximately [X] personnel. It is the responsibility of AMISP to deliver this training. Standard curriculum designed and agreed by the **MVVNL** for hardware, software and network preferably shall be arranged by the AMISP for each group. The **MVVNL** will prefer if a portion of the training is conducted on-site.
- b) **End User Training** - The AMISP will provide training to the owner's team on a "Train the Trainer" basis. The **MVVNL**'s team so trained will then train all of the **MVVNL**'s end users. It is estimated that this training will require around [X] groups, with each group comprising of around [X] persons. These training sessions will be required to be conducted at any of the sites. The recommended training material can be in paper / electronic media with courses on Business Process Automation software fundamentals, business process overview, job activity training, and delivery options being on-line, CBTs, instructor led classrooms, etc.

### 8.2 Training modules

The training modules shall include but not be limited to ~~<MVVNL to update the list of training as required>~~:

- a) AMI Administration & Configuration
- b) AMI Installation and troubleshooting
- c) Application Management and Operations
- d) Database and Data Analysis Reports
- e) Cyber Security
- f) Smart Meter and communication technology

An indicative list of training is as provided below.

Item No.	Description	No. of Trainees	Duration in weeks		Total Man-weeks	
			At facility <b>MVVNL's</b>	At AMISP's facility	At facility <b>MVVNL's</b>	At AMISP's facility
1	Smart Grid components Hardware and Software Course	30	1	1	30	30
2	Database, Report and Analytic Building Course	10	1	1	10	10

Item No.	Description	No. of Trainees	Duration in weeks		Total Man-weeks	
			At facility MVVNL's	At AMISP's facility	At facility MVVNL's	At AMISP's facility
3	Application Software	20	1	2	20	40
4	Operator training & Maintenance course	40	1	0	40	0
5	Smart Meter & Communication network	15	1	0	15	0
6	Cyber Security Training course	5	0	1	0	5
Total		120	5	5	115	85

### 8.3 Training Schedules

As part of the project implementation plan (refer Clause 10.1 of this Section), the AMISP shall draw up a training schedule in consultation with the MVVNL. This will enable the MVVNL representatives gain knowledge and understanding of the activities during the following stages of the project implementation, so that they may discharge effective oversight and witness capabilities.

1. Pre-FAT
2. Pre-Operation Go-Live
3. Operation and Maintenance
4. End of Contract

The training modules as described in Clause 8.2 shall be distributed among these phases of the training schedule and mutually agreed.

### 8.4 General Requirements

General requirement for training to be imparted is as follows:

- a) Training shall be conducted by AMISP personnel who are experienced instructors and speak understandable [language name].
- b) The AMISP shall provide training to various user groups nominated by the MVVNL. The AMISP shall provide the Training Approach in the response
- c) All necessary training material shall be provided by the AMISP. Each trainee shall receive individual copies of documents used for training. Training material shall be organized by functional process that will serve as the training documentation for a particular functional area.
- d) Training materials, including the documents provided to the trainees as well as handouts, shall become the property of the MVVNL. The MVVNL reserves the right to copy such materials, but for in-house use only.
- e) For all trainings the travel expenses of the MVVNL will be borne by the MVVNL.

- 
- f) The schedule, location, detailed contents, for each course shall be finalized during detail engineering. The number of participants in the training program may undergo change. However, all the training courses shall preferably be conducted in single batch. Training shall be done in batches comprising of Introduction, Basic and Advanced categories.
  - g) The training will consist of a curriculum of courses to address the issues of system operation, system troubleshooting, business-wide application, changed business processes and general use of the new system.
  - h) Representatives from the AMISP, **MVVNL**'s project management teams will be involved throughout in the development of training strategy, training material design and development, standards and training delivery to ensure that change management issues are incorporated, and that training strategies and materials are aligned to the requirements of the project and as business-specific as possible.
  - i) Two Engineer's from the **MVVNL** shall be stationed at the AMISP's works during development/customization of solution as per the RFP. The deputed **MVVNL** engineers shall be involved with the project till its completion.

## **9. Tests, Inspections and Management of the Quality Assurance / Quality Control Program**

### **9.1 Responsibility of Tests and Inspection**

Test and inspections are in the complete purview of the AMISP and its sub-vendors. It shall be ensured that there are no conflicts in roles played between AMISP personnel carrying out tests / inspections, and those assigned responsibilities of quality assurance (QA) and quality control (QC).

The QA/QC organization of the AMISP shall be an independent administrative and functional structure reporting via its manager to the AMISP's top management. The QA/QC manager(s) shall have the authority within the delegated areas of responsibility to resolve all matters pertaining to quality when actual quality deviates from that stated in the Work Statement. The personnel performing QA/QC functions shall have well-defined responsibility, authority, and organizational freedom to identify and evaluate quality problems and to initiate, recommend, or provide solutions during all phases of the Contract.

The QA/QC Manager designate for the project shall be the custodian of all inspection and test records/certificates. QA/QC Manager either directly or through its authorized representative shall be responsible for all witness testing, approval of test records and in general, management of the QA/QC program of the project.

The responsibility for inspections and tests is borne by the Inspections and Tests Manager. This team is responsible for creating the various inspection and test procedures and under the general supervision of the QA/QC Manager, conducts the tests.

In the event any imports are required for the purposes of this AMISP Contract, such imports shall be in accordance with all applicable laws including those issued by Ministry of Power (Order No. No.9/16/2016-Trans-Part(2) dated 18 November 2020; as amended and/ or modified from time to time) for testing of imports including those from prior reference countries.

### **9.2 In-Process Inspection**

#### **9.2.1 Type Testing and Data Exchange Protocol Testing**

Type Tests shall be defined as those tests which are to be carried out to prove the design, process of manufacture and general conformity of the product as per BIS standards . The Data Exchange Protocol Tests are defined as those tests which establish compliance with DLMS/COSEM application layer. The Type Testing and the Data Exchange Protocol Testing shall comply with the following general conditions.

- a) The QA/QC Manager shall document, within scheduled period as per project plan, copies of test reports and certificates for all the Type Tests that are specified in the specifications and that have previously been performed. These certificates shall apply to items and equipment that are essentially identical to those due to be delivered under the Contract and test procedures and parameter values shall be identical to those specified in this specification. The type tests shall be carried out at nationally/Internationally accredited labs and type test certificates shall not be more than three years old.



- b) Type Tests shall be performed for all equipment types for which certification is not provided as required above. If any of the type tests are required to be carried out, the same shall be carried out by the AMISP.
- c) For direct connected Smart Meters, the Type Tests shall follow IS 16444 read in conjunction with IS 13779. The test schedule adopted for running the Type Tests along with the sampling criteria and the criteria for conformity shall follow IS 13779.
- d) For transformer operated Smart Meters, the Type Tests shall follow IS 16444 (Part 2) read in conjunction with IS 14697. The test schedule adopted for running the Type Tests along with the sampling criteria and the criteria for conformity shall follow IS 14697.
- e) For pluggable NIC modules, the type tests shall be carried out with the NIC module integrated in the field device, that is meters and DCUs being supplied under the project.
- f) Type Tests and Data Exchange Protocol Tests shall be certified or performed by nationally/internationally reputed laboratories using material and equipment data sheets and test procedures that have been developed for the project. The test procedures shall be formatted as in the specifications and shall include a complete list of the applicable reference standards before commencement of test (s).
- g) The AMISP shall prepare a detailed schedule for performing all specified type tests.
- h) The AMISP shall ensure that all type tests can be completed within the time schedule offered in its Technical Proposal.
- i) In case of failure during any type test, the AMISP shall follow the conformance criteria as laid out in corresponding standard (refer serial number c and d above)
- j) For direct connected Smart Meters, the Data Exchange Protocol Tests shall follow IS 16444 (Part 1) read in conjunction with IS 15959 (Parts 1 & 2). The sampling criteria for running these tests shall be [one per one lakh] smart meters under production.
- k) For transformer operated Smart Meters, the Data Exchange Protocol Tests shall follow IS 16444 (Part 2) read in conjunction with IS 15959 (Parts 1 & 3). The sampling criteria for running these tests shall be [one per one lakh] smart meters under production.
- l) Documentation for all factory, field, and availability tests that apply to the AMI system shall be provided in accordance with the requirements defined in this section of specification

### 9.2.2 Quality Assurance and Quality Control Program

The QA/QC Manager shall maintain a Quality Assurance/Quality Control (QA/QC) program that provides that equipment, materials and services under this specification whether manufactured, designed or performed within the AMISP's plant, in the field,

or at any sub-contractor's source shall be controlled at all points necessary to assure conformance to contractual requirements.

The program shall provide for prevention and ready detection of discrepancies and for timely and positive corrective action. The QA/QC Manager shall document objective evidence of quality conformance.

Instructions and records for quality assurance shall be controlled and maintained at the system levels. The AMISP shall outline its QA/QC program plan along with any supporting documents in the Technical Proposal and update the QA/QC program document following site the survey.

A Quality Assurance Program of the AMISP shall cover but not be limited to the following:

- a) The organization structure for the management and implementation of the proposed Quality Assurance Program
- b) Documentation control system
- c) Qualification data for key personnel
- d) The procedure for purchase of materials, parts/components and selection of Sub-contractors' services including vendor analysis, source inspection, incoming raw material inspection, verification of material purchases, etc.
- e) System for shop manufacturing including process controls
- f) Control of non-conforming items and system for corrective action
- g) Control of calibration and testing of measuring and testing equipment
- h) Inspection and test procedure for manufacture
- i) System for indication and appraisal of inspection status
- j) System for quality audits
- k) System for authorizing release of manufactured product
- l) System for maintenance of records
- m) System for handling, storage and delivery
- n) A Quality Plan detailing out the specific quality control procedure adopted for controlling the quality characteristics of the product.

The QA/QC Manager shall be required to make available to the Inspection and Testing Team, all the Quality Assurance Documents as stipulated in the Quality Plan at the time of inspection of equipment/materials.

### 9.2.3 Scope and Duties of QA/QC Program Manager

The QA/QC Manager of the AMI Project shall have the right to carry out Quality Audit and Quality Surveillance of the systems and procedures of the AMISP's/his vendor's Quality Management and Control Activities. The scope of the duties of the

---

QA/QC Manager, pursuant to the Contract, will include but not be limited to the following:

- a) Review of all the AMISP's drawings, engineering data etc.
- b) Witness or authorize its representative to witness tests at the manufacturer's works or at site, or at any place where work is performed under the Contract.
- c) Inspect, accept or reject any equipment, material and work under the Contract in accordance with the specifications.
- d) Issue certificate of acceptance
- e) Review and suggest modification and improvement in completion schedules from time to time; and
- f) Monitor the Quality Assurance program implementation at all stages of the works.

#### **9.2.4 Inspection and Test**

All materials furnished and all work performed under this Specification shall be inspected and tested. Deliverables shall not be shipped until all required inspections and tests have been completed, all deficiencies have been corrected, and the equipment has been approved for shipment by the QA/QC Manager

Documents identified in the hardware and software quality assurance plan and procedures shall be inspected to verify that the required quality assurance activities have been performed in the manufacturing process of hardware and software.

Inspections will include visual examination of hardware, enclosure cable dressings, and equipment and cable labelling.

Should any inspections or tests indicate that specific hardware, software or documentation does not meet the Specification requirements, the appropriate items shall be replaced, upgraded, or added by the AMISP as necessary to correct the noted deficiencies. After correction of a deficiency, all necessary retests shall be performed to verify the effectiveness of the corrective action.

The test shall be considered complete when (a) when all variances have been resolved; (b) all the test records have been filed; (c) QA/QC Manager acknowledges in writing the successful completion of the test.

##### **9.2.4.1 Test Plans & Procedures**

Test plans shall be provided by the QA/QC Manager, for all tests to ensure that each factory and field test is comprehensive and verifies all the features of the equipment are tested.

The Inspection and Test Manager in AMISP shall prepare detail testing procedure in line with specification. The procedure shall be modular to the extent possible, which shall facilitate the completion of the testing in the least possible time.

During the development of test plans and test procedures for the system, emphasis shall be placed on testing each conditional logic statement, checking error conditions, and documenting the simulation techniques used. The test plans and test

procedures shall be modular to allow individual test segments to be repeated as necessary.

#### **9.2.4.1.1 Test Plans**

The test plans shall describe the overall test process, including the responsibilities of individuals and the documentation of the test results. The following shall be included in the test plans:

- a) Test schedule on a day-by-day basis
- b) Responsibilities of test engineer and QA/QC personnel
- c) Record-keeping assignments, procedures, and forms
- d) Procedures for monitoring, correcting, and retesting variances
- e) Procedures for controlling and documenting all changes made to the hardware and software after the start of testing
- f) Block diagrams of the hardware test configuration, the external communication channels, and any test or simulation hardware.

#### **9.2.4.1.2 Test Procedures**

The test procedures shall describe the individual tests segments and the steps comprising each segment, particularly the methods and processes to be followed. The test procedures in general shall include the following items:

- a) Name of function to be tested;
- b) References to the functional, design, user, and any other documents describing the function;
- c) List of test segments to be performed and the purpose of each test segment;
- d) Set-up conditions for each test segment, including descriptions of the test equipment;
- e) Descriptions, listings, and instructions for test software tools and displays if any;
- f) Step-by-step descriptions of each test segment, including user actions for each test step;
- g) Expected results for each test segment, including pass/fail criteria;
- h) Descriptions of the techniques and scenarios to be used to simulate system field inputs and controlled equipment;
- i) Copies of any certified test data to be used in lieu of testing.

#### **9.2.4.1.3 Test Records**

The complete record of all factory and field acceptance tests results shall be maintained by the designated QA/QC Manager of AMISP. The records

shall be maintained in a logical form and shall contain all the relevant information. The test reports shall be signed by the inspection & testing engineer and the QA/QC representative witnessing the tests. The records shall be keyed to the test procedures. The following items shall be included in the test records:

- a) Reference to appropriate test procedure
- b) Date of test
- c) Description of any test conditions, input data, or user actions differing from that described in the test procedure
- d) Test results for each test segment including a pass/fail indication
- e) Identification of AMISP's test engineer and QA/QC representative.
- f) Provision for comments by test engineer and QA/QC representative
- g) Copies of any variance reports generated
- h) Copies of reports, display copies, and any other hardcopy generated as part of the test.

#### **9.2.4.1.4 Reporting of variances**

Starting from the dry run test period, a variance report shall be prepared by the inspection and testing engineer each time a deviation from the requirements of this Specification is detected in areas such as system functions, design parameters, performance, documentation, test plans, and test procedures. Record of all such variances and their resolution shall be maintained by the QA/QC Manager.

However, at any stage if QA/QC Manager feels that quality of variances calls for suspension of the testing the testing shall be halted till satisfactory resolution of variances, which may involve retesting.

The report shall include a complete description of the variance, including:

- a) Sequential identifying number assigned to the variance
- b) Date and time the variance was detected
- c) Appropriate references to the test procedures and this Specification
- d) Description of test conditions at the time the variance was detected
- e) Identification of testing and QA/QC representatives
- f) Estimated date and time when variance is expected to be fixed
- g) Description of the corrective actions taken (to be completed as part of the variance resolution process
- h) Dated signature lines for the QA/QC and test representatives to signify reporting and correction of the variance.

Each variance shall be assigned to one of three classes defining the action to be taken to resolve the variance:

- a) Class 1: Testing will immediately stop and the AMISP will evaluate and correct the variance before testing is resumed
- b) Class 2: Testing will continue, and the variance will be evaluated and corrected by the AMISP at the end of the current session but prior to further testing
- c) Class 3: Testing will continue, and the variance will be evaluated and corrected at a mutually agreed upon time between QA/QC Manager and the Inspection and Testing Manager.

The class shall be assigned by the QA/QC representative.

The QA/QC Manager shall maintain and periodically distribute a variance summary that lists for each variance the report number, a brief description of the variance, its class, and its current status (open or resolved).

All actions taken to correct variances shall be documented on the variance report by the AMISP. Sufficient information shall be recorded to enable QA/QC representative to determine the need for and extent of retesting, the need for testing interactions of the correlation with any previously tested hardware or software, and the need for updating appropriate documentation. A variance shall be deemed resolved after retesting has been performed satisfactorily and the test engineer and QA/QC representatives have acknowledged correction of the variance on the variance report.

#### 9.2.4.2 Test Initiation

The following conditions must be satisfied before starting any test

- a) All test plans and procedures for the test shall be available.
- b) All hardware and software engineering design change orders shall be incorporated into the system under test.
- c) All relevant documentation including drawings, lists of deliverables, and software functional and design documents, and user manuals shall be available.
- d) A complete regeneration of the software under test shall be performed immediately prior to the start of factory testing.
- e) All operating system parameters, files, and configuration information shall be saved to archive media so that the AMI systems operating environment can be recreated starting with an un-initialized system. The existence and completeness of this data shall be demonstrable.
- f) All database, display, and report definitions shall be saved to archive media so that the databases, displays, and reports can be recreated if necessary.
- g) The image backup of all applications of AMI Systems shall be taken on the archive media so that AMI systems software can be regenerated if necessary.
- h) A complete dry run of each factory test (excluding the integrated system test) shall be conducted by the AMISP using the test plans and test procedures.

### 9.2.4.3 Test Completion

A test shall be deemed to be successfully completed only when:

- a) All variances have been resolved
- b) All test records have been documented and issued
- c) QA/QC acknowledges, in writing, successful completion of the test.

### 9.2.5 Factory Acceptance Test (FAT)

The factory tests shall be conducted on all the equipment to be supplied under the project. FAT<sup>1</sup> shall include, but not be limited to the following, appropriate to the equipment being tested:

- a) Verification of all functional characteristics and requirements specified.
- b) Inspection and verification of all construction, wiring, labelling, documentation and completeness of the hardware

Arrangements shall be made to carry out the tests for pluggable NIC modules integrated into three different meter makes, including the make(s) of meter being supplied by the AMISP. The slot for plugging the NIC modules in the meter shall conform to this specification. The FAT shall be carried out on the meter and/or DCU integrated with the NIC modules. If any on-line communication failover has been agreed between the MVVNL and the AMISP, tests shall be carried out to check a seamless failover of communication. The three makes of meters shall be checked with NIC modules for all type of communication technologies selected for the project.

Before the start of factory testing, the QA/QC Manager shall verify that all changes applicable to the equipment have been implemented, type test certificates and Data Exchange Protocol Certificates (as per sampling criteria specified) are available. As a part of the factory tests, unstructured testing shall be performed to enable proper verification of operation of the equipment under conditions not specifically tested in the above structured performance test. All special test facilities used during the structured performance test shall be made available for use during unstructured testing. On the approval of the QA/QC Manager, The Project Manager of the AMISP to inform the schedule of FAT to MVVNL as soon as finalised, with changes, if any. If the MVVNL so desires, it may choose to witness the FAT at its own cost.

#### 9.2.5.1 Factory Test Requirements

- a) The database displays and the report formats developed for the central system by the AMISP shall be demonstrated and verified at the start of factory testing.

---

<sup>1</sup> It is expected that the FAT for equipment supplies shall happen in phases of delivery. For this a test cum development system environment shall have to be created for the AMI system, with the HES, MDM and Database application servers installed in the target cloud data centre. This test / development system environment shall be separate from the production environment and shall continue to serve the purpose of development system beyond the FAT phase, for the total duration of the project

- b) All Field Device, AMI functions, communication & networking systems as well as performance shall be tested and demonstrated.
- c) The AMISP shall also carry out testing of the standard protocol implementation for successful integration before the FAT starts.
- d) All hardware and software associated with AMI Systems shall be staged and completely tested with simulated data at the AMISP's facility.
- e) For smart meters, the FAT shall be governed by the Routine and Acceptance tests as laid out in IS 13779 and IS 14697.
- f) The Tests and Inspection Manager of the AMISP is responsible for conducting all factory tests.
- g) Each of the factory tests described below (i.e., Routine & Acceptance Test of Smart Meters, the hardware integration test, the functional performance test, and the integrated system test, unstructured tests) shall be carried out under factory test stage.

#### 9.2.5.2 Sample Routine & Acceptance Tests for Smart Meters

- a) These tests for Smart Meters are in addition to the Type Test requirements specified under clause 9.2.1 and the Routine and Acceptance tests that the AMISP will carry out as a part of their FAT procedure.
- b) The sample Routine and Acceptance tests as per IS 13779 and IS 14697 shall be performed in a third-party NABL accredited laboratory. The **MVVNL** shall have the authority of selecting the samples (in accordance with IS 13779 and IS 14697) for carrying out the Routine and Acceptance Tests. The AMISP shall be obliged to undertake these tests at their own cost. The conformity requirement shall follow IS 13779 and IS 14697 as the case may be.
- c) The AMISP shall be responsible for packing, handing over the material to the respective labs and ensuring transportation of the material directly from the manufacturer's location to the Labs for testing and delivering the material to site after successful test results are obtained. The AMISP shall be obliged to undertake all expenditures that shall be incurred towards packing, transport, inspection, testing charges etc.
- d) The lot wise testing shall be as per following methodology:
  - i. Sample Routine & Acceptance Tests shall mandatorily be carried out for the 1<sup>st</sup> lot through NABL Accredited Lab, before installation commencement. and thereafter the same can be done at discretion of **MVVNL** on subsequent lots on random basis not exceeding a total of 6 times (i.e. 1 random sample test per 10,000 lot).
  - ii. In addition to the above, the **MVVNL** reserves the right to carry out accuracy tests, in line with the above guidelines, in their own Meter testing Laboratory for each lot. The sample size for such test would be [5%] of the smart meters of each lot.



- e) The material clearance for installation / commissioning of the lots under the inspection shall only be issued post successful test results from the labs are provided to the **MVVNL** by the AMISP.
- f) Failure of Inspection/Testing
  - i. In case a meter fails in the test, the whole offered lot would be rejected and complete lot of meters under inspection will be required to be replaced by the AMISP, at its own cost.
  - ii. If in subsequent inspection of the new lot, the meter again fails the inspection, then the meter shall be rejected, and vendor/sub-vendor shall also be blacklisted.

### 9.2.5.3 Hardware Integration Test

The hardware integration test shall confirm that the computer hardware conforms to this Specification and the AMISP-supplied hardware documentation. The hardware integration test shall be performed when the computer hardware has been installed in the AMISP's factory. The operation of each item shall be verified as an integral part of the system. Applicable hardware diagnostics shall be used to verify that each hardware component is completely operational and assembled into a configuration capable of supporting software integration and factory testing of the system. Equipment expansion capability shall also be verified during the hardware integration test.

### 9.2.5.4 Functional Performance Test

The functional performance test shall completely verify all features of the AMI Systems hardware and software. This shall mean the suit of application software shall be made to run on the actual CSP infrastructure integrated with the field level hardware components, using selected communication paths. As a minimum, the following items shall be included in the functional performance test:

- a) Inspection of all equipment for conformance to drawings/document and satisfactory construction and appearance
- b) Testing of the proper functioning of all software, including test cases with normal and exception user-entered inputs and responses
- c) Simulation of local error and failure conditions
- d) Verification that ultimate expansion requirements are met
- e) Verification of data link interfaces with other Central systems
- f) Verification of Field Device communication interfaces (with failover if any) and data link interfaces with other central systems. This shall include the tests of three makes of meters with different types of NIC modules.
- g) Simulation of Field Device and data link communication errors and channel failures, including incorrect check codes and random channel noise bursts

- h) Testing of all user interface functions, including random tests to verify correct database linkages
- i) Simulation of hardware failures and input power failures to verify the reaction of the system to server and device failure
- j) Demonstration of all features of the database, display, and report generators and all other software maintenance features. These shall include but not be limited to functional features like pre-payment calculations, billing determinants, tariff settings, energy audit, generation of NMS reports, data base maintenance functions etc.
- k) Demonstration of the software utilities, libraries, and development tools
- l) Verification that the computer system meets or exceeds performance requirements
- m) Verification of the accuracy of hardware and software documentation via random tests
- n) Sample check of meter calibration accuracy and testing of spare parts.

#### 9.2.5.5 Integrated System Test

The integrated system test shall verify the stability of the system hardware and software after the functional performance test has been successfully completed. During the integrated system test, all functions shall run concurrently and all AMISP-supplied equipment shall operate for a continuous 100-hour period. This minimum level of activity may be augmented, by other activities that represent normal day-to-day operation of the system as long as these activities are conducted in accordance with the documentation provided with the system. These other activities may include, but shall not be limited to, database, display, and report modifications, software development activities, configuration changes (including user-commanded server and device failovers), and the execution of any function described in this Specification.

The integrated system test shall ensure that the computer system is free of improper interactions between software and hardware while the system is operating as an integrated unit. In case during the 100-hour period testing, un-commanded functional restart or server or device fail occurs the test shall be extended by 24 hours each time such a failure over occurs. Further the test shall not be conducted with the failed device.

#### 9.2.5.6 Unstructured Testing

Periods of unstructured testing shall be allocated to allow AMISP to verify proper operation of the systems under conditions not specifically included in the test procedures. Unstructured testing shall be conducted in compliance with the following conditions:

- a) A minimum of 25 percent of the actual test period shall be reserved for unstructured test of the system

- b) The AMISP's Tests & Inspection Manager along with the QA/QC representative shall be present during unstructured test periods
- c) All simulation software, test cases, and other test facilities used during the structured portions of the factory tests shall be available for use during unstructured testing
- d) Unstructured testing shall not begin prior to the start of the functional performance test
- e) Unstructured testing shall be allowed at the discretion of QA/QC Manager both at the end of a structured test segment and after completion of the functional performance test.

#### 9.2.5.7 Dispatch of Material to Site

The Material Inspection Clearance Certificate (MICC) for all hardware shall be issued by **MVVNL** only after successful completion of FAT as per specification. For this the QA/QC Manager of the AMISP is obliged to submit a comprehensive FAT clearance report to the **MVVNL**. At least 10 Field Devices for each protocol shall relate to each central system and the remaining Field devices shall be simulated in the factory test environment. The data exchange between central systems shall also be simulated in the factory test environment.

All Equipment Suppliers/OEMs to the project shall make use of categorised Interim Inspection Reports (CIP Clearance) from **MVVNL** to ship materials to site after completion of FAT. CIP shall be issued by the **MVVNL** subject to specific FAT report carried out under the responsibility of the QA/QC Manager. Categorised Interim Inspection Report with the lowest category would mean a complete failure of FAT and hence rejection of material. A category between the lowest and the highest, shall mean pending actionable points of minor nature, but material deemed fit for dispatch to site. The category of CIP shall be authorised by the QA/QC Manager and issued by the **MVVNL**. In case where CIP is authorised by the QA/QC Manager with the highest category (with no pending actionable points in FAT), the **MVVNL** shall issue a Material Inspection Clearance Certificate (MICC)

..

### 9.3 Field Installation and Integration Test (FIIT)

Before the start of the FIIT, the following steps have to be completed:

- a) Sample Routine & Acceptance Tests for Smart Meters

These tests for Smart Meters as specified in clause 9.2.5.2 may be repeated at the discretion of the **MVVNL** on lots received in the warehouse of the AMISP at site.

The sample Routine and Acceptance tests as per IS 13779 and IS 14697 shall be performed in a third-party accredited laboratory. The **MVVNL** shall have the authority of selecting the samples (in accordance with IS 13779 and IS 14697) for carrying out the Routine and Acceptance Tests. The AMISP shall be obliged to undertake these tests at their own cost. The conformity requirement shall follow IS 13779 and IS 14697 as the case may be.

- b) All field level hardware which has undergone FAT shall be installed at the site and the installation report signed off.
- c) Before the delivery of the first lot of field devices (meters/DCUs etc.),
  - a. The production hardware (servers, WS, LAN/Routers, FW, etc.) and software shall be provisioned at the cloud data centre.
  - b. The IT hardware shall be installed and made functional at the NOMC with requisite connectivity to the cloud data centre.
- d) The installed field hardware shall be configured and registered in the production environment of the cloud data centre.
- e) It shall be ensured that the smart meter deployment follows a contiguous area coverage plan. This is to mean for each installation of DT meter, attempt shall be made to prioritize deployment of all downstream consumer meters and for each installation of feeder meter, similar effort shall be made to prioritize deployment of all downstream DT/Boundary meters. However, this requirement of contiguous area coverage plan may exclude dispersed metering for certain industrial, commercial and government consumers at non-contiguous electrical locations as per the scope of work

It shall be the responsibility of the AMISP to devise the FIIT tests regime. The tests regime so developed shall be shared with the **MVVNL** at the time of submittal of the QA Plan. Any comments received from the **MVVNL** shall be addressed within the FIIT. At the minimum the following tests shall be performed.

- a) Proper registration of the incoming population of field devices
- b) Checking of user interface linkages with database
- c) Remote configuration downloads and reading of profiles
- d) If required checking of new meter readings with existing meter readings.
- e) Forced event creation and communication of such events
- f) Performance tests of device communication links
- g) Device communication link failover
- h) Integration tests with the MDM in line with a use case table to be drawn up by the AMISP. A use case table is provided in Clause 2.4 of this Section for reference purpose

Appropriate notice shall be sent to the **MVVNL** by the QA/QC Manager before the start of the FIIT test regimes to enable the **MVVNL** to witness the same.

### 9.3.1 Tests on receipt of complaint by consumer

During the project period, in case of receipt of complaint by consumer of faulty meter reading within three months of installation, the AMISP would follow the policies of the **MVVNL** or corresponding regulations that have been laid out. For this purpose, the **MVVNL** may also install its own check meter. In case of any discrepancy, based on the process followed as per the prevalent **MVVNL** policy / regulation, the lot shall be subjected to Routine & Acceptance Test through Third Party NABL Accredited Lab. If the lot is found faulty, the same shall be replaced by the AMISP at its own cost.

### 9.4 Site Acceptance Test (SAT)

Once the AMISP finalizes the SAT schedule, the QA/QC Manager shall invite the **MVVNL** to witness the tests as per their convenience.

SAT shall be carried out with Smart Meters/DCUs in lots as these are delivered and passes through the Field Installation and Integration tests. The first lot to be subjected to SAT shall consist of the complete cloud data centre and its hardware and software components along with supply, installation & integration of a minimum of [5%] Smart Meters/ DCUs (along with its related hardware and software equipment). The SAT for remaining meter population shall be staged on monthly basis based on the monthly supply, installation and integration of Smart Meters (along with its related hardware and software equipment).

The AMISP shall start up and check the performance of the equipment of field locations. All hardware shall be aligned and adjusted, interfaces to all inputs and outputs installed, operation verified, and all test readings recorded in accordance with the AMISP's recommended procedures. The SAT shall exhibit generally all functions of the equipment and duplicate factory test. All variances must be corrected prior to the start of the SAT. The list of final tests to be carried out in the field shall be listed in the site-testing document by the AMISP. Among others, the site testing document shall include the following minimum performance tests:

Data Type	Performance Requirement
<b>1. Load Profile Data Read<sup>2</sup></b>	
One-month block load profile for installed meters	From 98% of the meters in 12 hours after the midnight
<b>2. Billing Profile Data Read<sup>3</sup></b>	
Billing profile data for installed meters	From 98% of the meters in 12 hours after the midnight
<b>3. On-Demand Remote reads of meters</b>	
Collection of 7 days of interval energy data and the current total accumulated energy from a selected individual meter	Within 2 minutes
<b>4. Remote connect / disconnect</b>	
Action to response for individual meter	Less than 3 mins
<b>5. Updating of data on consumer portal/ app</b>	
Updating of individual consumer data on portal/ app after receiving the data in MDM	Action performed for active on portal consumers within 5 minutes after receiving the data in MDM
<b>6. Ping Response with acknowledgement/ response for selected meters</b>	
For installed meters	Action performed at 98% of meters within [5] minute; and
For an individual meter	Action performed within 3 seconds
<b>7. Meter loss and restoration of supply</b>	
Receiving of alert for all affected AMI meters	Alert to be received within 3 minutes for 60% of meters
<b>8. Meter Tamper Alerts</b>	

<sup>2</sup> This performance test shall be done during SAT, from second lot of meters onwards

<sup>3</sup> This performance test shall be done during SAT, from second lot of meters onwards

Data Type	Performance Requirement
Receiving of alert for an individual meter	Alert to be received within 3 minutes
<b>9. Power Quality Alerts</b>	
Receiving of alert for an individual meter	Alert to be received within 5 minutes
<b>10. Firmware upgrade with acknowledgement/ response for selected meters</b>	
For installed AMI meters (for a batch of at least 20% of installed base)	Action performed at 99% of meters within [18] hours; and
	Action performed at 99.9% of meters within [24] hours
<b>11. Remotely altering settings in meter</b>	
For installed AMI meters (for a batch of at least 20% of installed base)	Action performed at 99% of meters within [8] hours; and
	Action performed at 99.9% of meters within [24] hours
<b>12. Remotely read events logs</b>	
For reading the full event log for installed AMI meter	Action performed at 90% of meters within [30] minutes; and
	Action performed at 99% of meters within 1 hour; and
	Action performed at 99.9% of meters within [6] hours.
<b>13. VEE processing</b>	
For all installed meters	Action performed in [15] mins
<b>14. Computation of Billing Determinants</b>	
For all installed meters	Action performed in [2] hours
<b>15. Prepaid Recharge</b>	
Payment success to consumer acknowledgement	Within 5 mins
Payment success to meter update (From MDM to HES to Meter)	<ul style="list-style-type: none"> <li>• From 90% of meters within 30 minutes</li> <li>• From 99% of meters within 1 (one) hour</li> </ul>
<b>16. MVVNL User Interface</b>	
Manual data entry of new value appears on screen	Less than 6 secs
Acknowledgement of any action request	Within 3 secs
Display update rate	2 secs
<b>17. Disaster Recovery Capability (Refer to Clause 2.7.3.3.9 of this Section for details)</b>	
Recovery Time Objective (RTO)	[4 hours] as agreed

Data Type	Performance Requirement
Recovery Point Objective (RPO)	[2 hours] as agreed
<b>18. On-Demand Remote reads of meters</b>	
Collection of 7 days interval energy data and the current total accumulated energy from a group of 10% of installed base of meters (configurable)	95% complete within 2 hrs 100% complete within 4 hrs

Interim inspection reports shall be generated if the SAT is unsuccessful at any stage and all variances shall have to be corrected and recorded. On successful completion of each lot of SAT a clear SAT Report shall be issued for the benefit of the **MVVNL**. These SAT reports shall be signed by both the Inspection and Tests Manager and the QA/QC Manager.

### 9.5 System Availability Test

QA/QC Manager will be responsible for oversight of the conduct of the availability test. The test shall consist of normal AMI Systems operations without special test equipment or procedures.

Test records defined in the availability test plan and procedures will be maintained by QA/QC Manager. AMISP will operate and maintain the system according to procedures described in the AMISP documentation. QA/QC Manager shall raise incident reports for every incident that is encountered and closed with response time, resolution time and hold times.

AMI systems maintenance on an on-call basis shall be provided by the AMISP during the availability test period. When on-site maintenance support is needed, qualified AMISP personnel shall arrive at the site within maximum four (4) hours of notification and shall keep records of the progress in problem resolution. For availability purposes, this service response time and the associated on-site maintenance time shall be taken into account as defined in sections of “Downtime” and “Hold time”.

The AMISP shall maintain an inventory of spare parts, which may be required to achieve the specified availability. These spares shall be in addition to the mandatory spares. All spare parts used during the availability test shall be drawn from AMISP’s inventory.

#### 9.5.1 Downtime

Downtime occurs whenever the criteria for successful operation defined in Clause 9.6.1 of this Section are not satisfied. Downtime shall be measured from the start of diagnostic procedures until full service is restored. In the event of multiple failures, the total elapsed time for repair of all problems (regardless of the number of maintenance personnel available) shall be counted as downtime. For onsite response the delay in response time (more than four hours) shall be added to downtime.

#### 9.5.2 Hold time

During the availability test, certain contingencies may occur that are beyond the control of any stake holder. These contingencies may prevent successful operation of the system but are not necessarily valid for the purpose of measuring AMI systems availability. Such periods of unsuccessful operation may be declared "hold time". Specific instances of hold time contingencies are:

- a) **Scheduled Shutdown:** During scheduled shutdowns, or if an equipment failure occurs while its backup device is scheduled out-of-service, the resulting system outage shall be hold time, provided that service can be restored according to AMISP-specified procedures within 30 minutes.
- b) **Power Interruption and Environmental Excursion:** Loss of power or manual shutdown in the event of loss of environmental control shall be considered hold time. If the system is operated during periods of power or environmental conditions beyond those specified, any resultant downtime shall also be considered hold time.
- c) **Intermittent Failure:** Periods during which an intermittent, recurring software or hardware failure is experienced will be considered hold time, provided that the AMISP is engaged in remedial action and normal functions can be restored by AMISP-defined procedures whenever the failure occurs. Instead of accounting for the actual intermittent downtime, one hour of downtime shall be counted for each 24 hours of otherwise successful operation while the problem persists.
- d) **Service Response Time:** A maximum four (4) hours of hold time will be allowed for the AMISP to respond to each call for maintenance support.
- e) **Corrected Design Defect:** Hold time may be declared to ensure against similar future occurrences if a failure occurs due to a defect in system design for which the AMISP defines and implements corrective measures. In such a case, hold time shall be allowed in increments of 24 hours to allow verification of the corrective action.

### 9.5.3 Test Duration and Criteria for Acceptance

After the elapse of [120 hours] of cumulative test time, the availability shall be calculated. Should availability fall short of specified percentage as defined in Clause 9.6.1 of this Section, the AMISP may either (a) Continue the test by moving the starting time of the test forward and continuing the test until the consecutive hours have been accumulated and the specified availability has been achieved subject to maximum of 5 days, Or (b) the AMISP may restart the test for 120 hours.

To establish that all failures have been satisfactorily repaired prior to the end of the availability test, no downtime, intermittent (hold time) failures, or more than one un-commanded fail over shall have occurred within 48 hours of the test's conclusion.

#### 9.5.3.1 Criteria for successful operation

The AMI system shall be designed to meet the system availability as defined below:

S. No.	System	Minimum System Availability Requirements
1.	Smart Meters	99.5%
2.	DCU/ AP	99.5%
3.	MDM	99.5%



S. No.	System	Minimum System Availability Requirements
4.	HES	99.5%
5.	NOMC Hardware such as UPS, Router, etc.	99.5%
6.	MVVNL and Consumer User Interface	99.5%

The total operational time shall not include the hold time. The system shall be considered available as long as all the requirements defined under Clause 9.5 are available.

## 9.6 Operational Go Live

### 9.6.1 Conditions to Be Met for Operational Go Live

The Operational Go Live of the AMI system shall be considered as completion of the SAT for [5%] or [25,000] of Smart Meters whichever is less (along with its related hardware and software equipment) supplied installed and integrated. AMISP's obligations for Operational Go Live of the system shall be deemed to be met when the following milestones are achieved:

- a) Completion of training obligations pre-Operational Go-Live;
- b) Supply, installation & integration of [5%] or [25,000] of Smart Meters of the respective project as per the definition of Go-Live/ UAT specified therein whichever is less (along with its related hardware and software equipment);
- c) Successful completion of SAT for the quantity of Smart Meters as mentioned in serial no (b) above;
- d) Successful completion of system availability test for 120 (one hundred twenty) hour. This shall be conducted on supplied systems under normal day-to-day operating conditions. The test shall verify the reliability and integrity of the Field devices, Central Systems, Communication & networking systems, database, displays, report, and all communication interfaces.
- e) Independent third-party cyber security audit

The Availability Test mentioned in Clause 9.6.1 (d) is meant for the initial supply as mentioned in Clause 9.6.1 (b). For the subsequent lots of Smart Meters along with associated equipment, only up to SAT will be required for operationalizing the lot.

### 9.6.2 Certification of Operational Go Live

Following the successful completion of System Availability Tests as per Clause 9.5 of this Section, the AMISP has to submit the following documentation to the MVVNL Project Manager:

- a. MVVNL certification of training obligations pre-Operational Go-Live
- b. SAT and resolved variance reports of initial installation phase co-signed by the QA/QC Manager and the Inspection and Test Manager.
- c. Availability and resolved incident reports of System Availability Test signed by QA/QC Manager
- d. Initial third-party Cyber Security Audit Report

Based on these submittals the **MVVNL** shall check for the completeness and accuracy of the submittals and issue Operational Go Live certificate to the AMISP in not more than [3] days from the date of submittal. Commercial operation shall be effective from the date mentioned in this certificate.

## 10. Project Management

Prior to AMI Project Implementation, the AMISP will prepare and submit a detailed project implementation plan, in consultation with the **MVVNL**, to ensure smooth takeover of existing **MVVNL** systems and any ongoing services under the scope of the AMI Project.

### 10.1 Project Implementation Plan would cover the following:

- i. Understanding of **MVVNL** and its requirement with respect to Project implementation;
- ii. Overall system architecture and system philosophy capable of scale-up;
- iii. Details of proposed methodology;
- iv. Schematic Diagram of Proposed System Configuration
- v. Strategy for deployment of feeder-wise smart meters and communication infrastructure
- vi. Detailed bill of quantities for materials and services (including any special equipment) necessary to meet the technical specifications, functional & performance requirements
- vii. An approach paper documenting the interfaces for integration with existing and future applications based on the information provided by **MVVNL**
- viii. Project team structure;
- ix. Line of Credit / Source of funding and supporting documents;
- x. Governance framework;
- xi. Resource planning and estimation;
- xii. Risk planning;
- xiii. Quality Assurance/ Quality Control of the Program (including Testing and Inspection);
- xiv. Data Privacy Approach
- xv. Cyber Security Approach;
- xvi. Site Survey result;
- xvii. Documents, Data Requirement Sheet, Drawing submission and approval;
- xviii. Installation & Field update schedule;
- xix. Repair and Maintenance Schedule including details on Spares Management;
- xx. Training schedule;

### 10.2 Key Personnel

The AMISP shall appoint at least the following personnel dedicated for the AMI Project

- a) **Project Manager:** She / he shall have the authority to make commitments and decisions that are binding on the AMISP. **MVVNL** will designate a Nodal officer to coordinate all project activities. All communications between the **MVVNL** and the AMISP shall be coordinated through the project manager and nodal officer. The project manager should be an expert in AMI Implementation including metering and related aspects, installation and management of Smart Meters, communication network, last mile connectivity, HES and MDM. The project managers shall be responsible for all communications between other members of the project staffs including sub-contractors, if any.
- b) **System Integration Expert:** An expert in System Integration covering application software, hardware and network installation, integration design and ability to manage multiple partners with different skill sets in different technology domains.

- c) **Cyber Security Expert:** An expert in cyber security related aspects covering planning and implementing high level system security requirements, managing data privacy and confidentiality, information flow through adequate authorizations, threat modelling and security testing
- d) **Communication Protocol Expert:** An expert in communication protocols and in implementing applications using different communication technologies and ensuring communication inter-operability across applications/functionalities

The project manager shall be responsible for bringing in the Cyber Security expert and Communication Protocols expert at the appropriate stage in the project as and when required.

### 10.3 Progress Report

A progress report shall be prepared by the AMISP for each month against the activities listed in the project schedule. The report shall be made available to **MVVNL** on a monthly basis on a mutually agreed schedule, e.g., the 5th day of each month. The progress report shall include all the completed, ongoing and scheduled activities and transmittals issued and received for the month. The progress report will also highlight the risks to the project and plan for risk mitigation.

### 10.4 Transmittals

Every document, letter, progress report, change order, and any other written transmissions exchanged between the AMISP and the **MVVNL** shall be assigned a unique transmittal number. The AMISP shall maintain a correspondence index and assign transmittal numbers consecutively for all AMISP documents. The **MVVNL** will maintain a similar correspondence numbering scheme identifying documents and correspondence that the **MVVNL** initiates.

### 10.5 Review Meeting

Progress meetings shall be scheduled by the **MVVNL** and attended by the AMISP each reporting period to review progress of the project. Progress meetings shall be used to review the progress report, written correspondence exchanged since the last meeting, and open action items. The review meeting will also be used to discuss upcoming milestones, support needed from the **MVVNL**, risk identified by the Program team, risk mitigation strategies and to make decisions for path forward.

The AMISP shall also attend technical meetings as and when required by the **MVVNL** to discuss technical aspects of the project and to review **MVVNL** comments on documents. When appropriate, these technical meetings shall be conducted as extensions to the progress meetings.

### 10.6 Document Review and Approval Rights

To ensure that the proposed systems conform to the specific provisions and general intent of the Specification, the AMISP shall submit documentation describing the systems to the **MVVNL** for review and approval.

The **MVVNL** will respond with written comments to the AMISP within Fifteen (15) calendar days after receipt of the documents. Documents requiring correction must be resubmitted by the AMISP to the **MVVNL** within fifteen (15) calendar days. The **MVVNL** will respond to resubmitted documents within seven (7) calendar days after receipt of the document. No Project Implementation Schedule relief is to be implied for documents requiring correction and resubmission to the **MVVNL**.

The **MVVNL** shall have the right to require the AMISP to make any necessary documentation changes at no additional cost to the **MVVNL** to achieve conformance with the Specification.

To help the **MVVNL** manage the review and approval of documents during any given period, the AMISP shall stagger the release of documents over the time allocated in the project schedule. The number and size of documents shall be factored into the document release schedule.

## 11. Document Requirements

List of documents to be provided by the AMSIP to the **MVVNL** over the entire Contract period has been provided below. The timelines for submission along with requirement of **MVVNL** approval (if required) have also been provided herewith:

S. No.	Documentation to be submitted	Frequency	Purpose <sup>4</sup>
<b>A</b>	<b>Pre-Operational Go-Live Phase (from the date of execution of the Contract till the date of achievement of the Operational Go-Live of the AMI system)</b>		
1	A checklist of all documents on which approvals from <b>MVVNL</b> or other agencies may be required;	Once	I
2	Consumer engagement plan;	Once	I
3	Detailed Project Implementation Plan including verification of all integrations with external systems as mentioned in this Contract and delineated in the approach paper created for the purpose	Once	A
4	Exit Management Plan	Once	A
5	Document/ drawings to indicate the following: i. Tentative location of devices/equipment for setting up communication network with power plan; ii. Confirmation of adequacy of space and AC power supply requirements. iii. Additional items required for interconnection with the existing/owner provided equipment/facilities; iv. Requirement of modification to existing earthing arrangement of NOMC and locations where communication equipment / devices etc. are to be installed, if any.	Once	I
6	As-Built Drawings	Updated	I
7	Quality Assurance Plan including the test plans for each stage of Testing.	Once	A
8	Type test reports, Guaranteed Technical Parameters of components and associated document as per Clause 9 of this section	Once	I
9	Data Exchange Protocol Test Certificate [one per one lakh] smart meters	Once	I

<sup>4</sup> I: Informational, no approval required from Utility, A: Approval required from Utility based on signed documents submitted by AMISP,

10	Consumer indexing as per the implemented AMI system	Updated	I
11	Notice to <b>MVVNL</b> to witness Factory Acceptance Test	Periodic	I
12	Factory Acceptance Test Reports with category if any	Periodic	I
13	Notice to <b>MVVNL</b> to witness Field Installation and Integration Test	Once	I
14	Field Installation and Integration Test Reports	Once	I
15	Notice to <b>MVVNL</b> to witness Site Acceptance Tests	Periodic	I
16	Site Acceptance Test Reports	Periodic	I
17	Progress report briefing the status of installation of meters and key challenges faced if any	Monthly	I
18	Notice to <b>MVVNL</b> to witness System Availability Test	Once	I
19	System Availability Test	Once	I
20	Certification for Operational Go Live with following documentation: i. SAT & resolved Variance Reports ii. Availability & resolved incident Reports iii. Completion of Training certificate iv. Third party Cyber Security Audit v. Document detailing security algorithm and security key generation method	Once	A
<b>B</b>	<b>Post-Operational Go-Live Phase (after the Operational Go-Live of the AMI system till the end of Contract Period)</b>		
1	Monthly progress report briefing the status of installation of meters and key challenges faced if any	Monthly	I
2	Reports as mentioned in this Contract which includes but not limited to the following: i. Service Level Agreement (SLA) performance report; ii. Monthly progress report including problems that arise with the installed AMI system (if any) including any cyber security related issues and corrective action taken by AMISP for the same.	Monthly	A
	iii. Reports mentioned in Clause 6 of the Section 6;	Monthly	I
	iv. Cyber Security Audit	Yearly	I
	v. Data Privacy Audit report;	Yearly	I
3	Change Requests / Change Notes	Periodic	A
4	Change Orders	Yearly	A

---

5	Operation and maintenance manual	Updated	I
6	Exit Management Plan	Updated	A

## 12. Project Implementation Schedule

The Project Implementation Schedule for AMI system establishment and timelines for Related Services milestones from date of execution of the Contract are given below:

S. No.	Milestone	Timeline (in months)
1	Submission of detailed Project Implementation Plan giving the compliance sheet along with the make and model of various infrastructure, hardware & software that are proposed for delivery and operations incl.: <ul style="list-style-type: none"> <li>• Specification of System</li> <li>• Architecture and Software Solution</li> </ul>	Within [60] days from the date of execution of the Contract
2	Approval of detailed Project Implementation Plan by <b>MVVNL</b>	Within [15] days from the date of submission of Project Implementation Plan.
3	Delivery, site installation, integration and operationalization of 100% of Feeder Meters each with related hardware, software and equipment	Within [9] months from the date of execution of the Contract
4	<ul style="list-style-type: none"> <li>• Delivery, site installation and commissioning of Network Operations cum Monitoring Centre with related hardware, software and equipment; and</li> <li>• Delivery, site installation, integration and operationalization of [5%] of Smart Meters each with related meter box, service cable, hardware, software and equipment and successful operational go-live</li> </ul>	Within [7] months from the date of execution of the Contract
5	Delivery, site installation, integration and operationalization of 50% of Smart Meters each with related meter box, service cable, hardware, software and equipment	Within [18] months from the date of execution of the Contract
6	Delivery, site installation, integration and operationalization of 100% of DT Meters each with related hardware, software and equipment	Within [18] months from the date of execution of the Contract
7	Installation Milestone	Within [27] months from the date of execution of the Contract
8	Certification of Installation Milestone in accordance with the provisions of this Contract by <b>MVVNL</b>	Within [15] days from the date of Installation Milestone.
9	Operational period of the AMI system	From Operational Go-Live till end of the Contract Period



S. No.	Milestone	Timeline (in months)
10	Transfer of AMI system to the <b>MVVNL</b>	At the end of Term of the Contract in accordance with Exit Management Plan provided in Article 11.6 of GCC in Section 7

### Installation Milestone

The “Installation Milestone” is defined as the milestone when installation and operationalisation is completed for the number of smart meters envisaged for the project. The AMISP is expected to complete this Installation Milestone as per the table given above. The number of smart meters envisaged may change through negative variations provided for in the Contract as mentioned in Article 14 given in Section 7. If the AMISP completes the “Installation Milestone” ahead of schedule, then the revised date shall be accepted as the date of achievement of “Installation Milestone”.

In accordance with Clause 1.15 (w) of this Section, the **MVVNL** shall provide necessary clearance/ approval/ permits that are to be issued by it for initial 20% of contiguous electrical locations for Smart Meter deployment along with related documentation within 6 (six) months from date of execution of this Contract. Furthermore, the **MVVNL** shall provide necessary clearance/ approval/ permits to be issued by it for remaining contiguous electrical locations as well as non-contiguous electrical locations for Smart Meter deployment along with related documentation on quarterly basis. **MVVNL** shall endeavour to provide 20% of contiguous electrical locations cleared each quarter and complete area within 18 (eighteen) months from date of execution of the Contract. The **MVVNL** shall issue a Notice no later than 7 days of expiry of time period specified above confirming the actual number of meters for which clearance/ approval/ permits is available. If the **MVVNL** fails to issue the necessary clearance and approvals or if the **MVVNL** acknowledges that no further consumer/feeder locations are available for deployment within the allotted time, then the meter population for which clearance/ approval/ permits is available shall be assumed as the number required for meeting the “Installation Milestone”.

As and when the “Installation Milestone” is achieved by the AMISP, the **MVVNL** shall be obliged to certify the milestone through a written communication giving the date and the meter population installed and operationalised.

## 13. Annexures

### Annexure A Technical Specifications for Whole Current A.C. Single Phase Smart Energy Meter

#### Scope

These specifications cover the design, manufacturing, testing, supply and delivery of AC whole current, single phase, 2 wires Smart Energy Meter with bidirectional communication facility & remote connect/disconnect switch. The meter shall communicate with Head End System (HES) on any one of the communication technologies mentioned in IS16444 Part 1, as per the requirement of the **MVVNL**.

#### Basic Features

The Smart Meter would have the following minimum basic features-

- Measurement of electrical energy parameters
- Bidirectional Communication
- Integrated Load limiting /connect/disconnect switch
- Tamper event detection, recording and reporting
- Power event alarms as per IS 16444 Part 1
- Remote firmware upgrade
- Pre-paid features at MDM end (as per IS 15959 Part 2)
- TOD features
- Net Metering(kWh) features (optional as per requirement of **MVVNL**)
- On demand reading

#### General standards applicable for meters

S. No.	Standard No.	Title
1	IS 13779 with latest amendments	AC Static Watt-hour Meter class 1& 2
2	IS 15884 with latest amendments	Alternating Current Direct Connected Static Prepayment Meters for Active Energy (Class 1 and 2)- Specification
3	IS 16444 Part 1 with latest amendments	A.C. Static Direct Connected Watt Hour Smart Meter Class 1 and 2- Specification
4	IS 15959 Part 1 & Part 2 with latest amendments	Data Exchange for Electricity Meter Reading, Tariff and Load Control-Companion Standards

#### Communication

Meter shall have the ability to communicate with Head End System (HES) on any one of the communication technologies mentioned in IS16444 Part 1 (RF/PLCC /Cellular) in a secure manner. The selection of communication technology should be as per the site conditions and as per design consideration of AMI Implementing agency to meet the performance as per agreed Service Level

Agreements (SLAs). In case of Cellular based meter, the meter shall accommodate SIM card/ e-SIM of any service provider. In case of Plug-in type communication module, the meter shall log communication module removal /non-responsive event with snapshot.

**Remote connect/disconnect/load limiting:** Remote Connect/disconnect/Load control facilities would be as per IS 16444 part 1.

#### **Other Specifications**

<b>Features</b>	<b>Minimum Requirement of Features</b>
Applicable Standards	The meters shall comply with IS 16444 Part 1 for all requirements.
Reference Voltage	As per relevant IS (240 V)
Current Rating	5-30 A 10-60 A
Category	UC1
Starting Current	As per IS 16444 Part 1
Accuracy	Class 1.0 as per IS 16444 Part 1
Limits of error	As per IS 16444 Part 1
Operating Temperature range	As per IS 13779
Humidity	As per IS 13779
Frequency	As per IS 16444 Part 1
Influence Quantities	As per IS 16444 Part 1
Power Consumption of meter	As per IS 16444 Part 1
Current and Voltage Circuit	As per IS 16444 Part 1
Running at No Load	As per IS 16444 Part 1
Test output device	As per IS 16444 Part 1
Meter Display	As per IS 16444 Part 1
Name Plate & marking Meter Display	As per IS 16444 Part 1
Parameters to be measured	As per IS 16444 Part 1 / As per IS 15959 Part-2
Maximum Demand resetting	As per IS 15959 Part 2
Time of Use registers	As per IS 15959 part 2
Power Quality Information	As per IS 15959 part 2
LED/LCD Indicators	As per IS 16444 Part 1
Load Survey/Interval Data	As per IS 15959 part 2
Tamper/ Event Recording	As per IS 15959 part 2

Features	Minimum Requirement of Features
Measuring Elements	As per IS 16444 part 1
Alarm	As per IS 16444 Part 1/ 15959 Part 2
Load Control	As per IS 16444 Part 1
Connect/Disconnect switch	UC1 (As per IS 16444 part 1)
Status of load switch	As per IS 16444 Part 1
Programmability	As per IS 16444 Part 1
Communication	As per IS 16444 Part 1
Data Exchange Protocol	As per IS 16444 Part 1
Remote Firmware upgrade	As per IS 15959 Part 2
Real Time Clock (RTC)	As per IS 16444 Part 1/ IS 15959 Part1 & Part 2
Data Retention	As per IS 16444 Part 1
Battery Backup	Meter shall be supplied with separate battery backup for RTC.
First Breath (power on) and Last gasp (power off) condition detection and communication to HES	As per IS 16444 Part 1
Plug-in Communication Module	The Smart Meters shall have a dedicated sealable slot for accommodating plug-in type bi-directional communication module which shall integrate the respective communication technology (RF/PLCC/ Cellular) with the Smart Meters, leading to easy adaptability for network interfaces (WAN/NAN). The Plug-In module shall be field swappable/ replaceable.

***Data display facility (auto/manual)***

As per IS 16444. However minimum requirement should include the following:

Data Display shall be in two modes-

1. Auto Scroll
2. Scroll with Push Button

The display parameters shall be:

- Auto Scroll
  - Display Check
  - Date and Time
  - Last Recharge Amount
  - Last Recharge Time
  - Current Balance Amount
  - Current Balance Time

- Cumulative Active Energy kWh with legend.
- Current calendar month MD in kW with legend.
- Instantaneous voltage
- Instantaneous Phase current
- Instantaneous Load kW
- Instantaneous average Power Factor

These parameters should be displayed on the Meter Display continuously for a period of 10 seconds on Auto scroll.

▪ Scroll with Push-button

All Parameters mentioned under Auto-Scroll mode should be displayed. Additionally, the following Parameters shall also be displayed:

- Internal diagnostics (display check)
- Meter Serial No.
- Cumulative Energy in kVAh Lag/ Lead with legend
- Cumulative Active Energy kWh ToD wise with legends.
- Cumulative Apparent Energy kVAh ToD wise with legends.
- Current month MD in kVAh with legends
- Last month cumulative kWh with legends
- Last month cumulative kVAh with legends
- Last month MD in kW with legends
- Last month Average Power Factor
- Current month Average Power Factor

Further, the Meter should display high resolution energy values with resolution of 3 digits before decimal and 2 digits after decimal in push button mode

The meter's display should return to default display mode (continues auto scroll) if push button is not operated for more than 10 seconds. (The order of display may be revised as per requirement of the **MVVNL**). Meter display should not go into sleep mode during Power-On condition.

***Anti-tamper features***

The meter shall continue recording energy under tamper conditions as defined in IS 15959 Part 2 and would log the event and send alarm at Head End System after detection of the defined tamper features as per IS 15959 Part 2.

***Type Tests & Test Certificates***

Smart Meter shall be type tested for all the tests as per relevant parts of IS 16444 (latest versions) and certified by Indian Standard wise list of BIS recognized labs as available at <https://bis.gov.in/index.php/laboratorys/list-of-bis-recognized-lab/>. The number of sampling for testing of meters and criteria for conformity would be as per IS 16444 (as amended up to date). Necessary copies of test certificates shall be submitted as per agreement with the **MVVNL**.

***Routine & Acceptance Tests***

The Factory Acceptance and Routine tests shall be carried out as per IS 16444 Part 1.

***General & Constructional requirements***

---

Meter shall be BIS marked as per IS 16444 Part 1. General & construction requirement shall be as per IS 16444/IS 13779

***Meter base & cover*** - Meter base & cover shall be as per IS 16444 Part1 / IS 13779. The meter Base & cover shall be 'Break to open' design. The material for meter base and cover shall be made of high-grade polycarbonate.

The meter Base & cover shall be ultrasonically welded / Chemically welded or other suitable bonding technology and it will not be possible to remove the cover from the base without evidence of damage

***Terminal block & cover*** - As per IS 16444 Part 1/IS 13779

***Design***

Voltage circuit, sealing arrangement, terminal block, terminal cover, and nameplate etc. shall be in accordance with IS-16444 Part 1(latest version).

The meter shall be compact and reliable in design, easy to transport and immune to vibration and shock involved in transportation and handling.

***Name plate and marking***

The name plate on the meter should be clearly visible, effectively secured against removal and indelibly/distinctly marked in accordance with relevant IS. In addition, "Name of the **MVVNL**", purchase order no. & year/month of manufacturing shall be provided on the name plate. The rating plate information shall be as per relevant IS.

***Connection diagram:*** As per IS 16444 Part 1

***Fixing arrangements***

The meter shall be mounted type. The Meter should have three fixing holes, one at top and two at the bottom. The Top hole should be such that the holding screw is not accessible to the consumer after fixing the meters. The lower screws should be provided under sealable terminal cover.

***Sealing arrangement:***

Arrangements shall be provided for proper sealing of the meter cover so that access to the working parts shall not be possible without breaking the seal. The sealing arrangement and number of seals shall be as per relevant IS/ requirement of **MVVNL**.

***Meter box:***

The Meter Box if required by **MVVNL**/purchaser, would be provided as per requirement of the **MVVNL**/ purchaser and the material of the Meter Box should be such that it does not hamper communications.

***Packing***

The meters shall be suitably packed for vertical/horizontal support to withstand handling during transportation. The meter shall be packed appropriately to ensure safe transportation, handling, identification, and storage. All packing materials shall be as per environment law in force. The primary packing shall ensure protection against humidity, dust, grease and safeguard the meter's performance until its installation. The secondary packing shall provide protection during transportation. The packing case shall indicate "Fragile in nature" and direction of placement of box. The packing shall indicate marking details like Manufacturer's name, S. No. of meters, quantity etc.

**Transportation**

- The meter shall be compact in design. The meter block unit shall be capable of withstanding stresses likely to occur in actual service and rough handling during transportation.
- The meter shall be convenient to transport and immune to shock and vibration during transportation and handling.
- The meter should not be exposed to undue shock and mishandling during transportation.
- The stacking of box inside transport media should be such as to avoid their free movement.
- The packing should also be protected from rain and dust by transport media.
- The AMISP shall be responsible for any damage during transit due to inadequate or improper packing.

**Testing and Manufacturing Facilities at Manufacturer's Place**

The manufacturer shall have facilities of conducting Acceptance Testing as per IS 16444 Part 1.

**Inspection**

- The meters shall be sealed as per the mutual agreement of the supplier and the purchaser
- The **MVVNL**/ purchaser may inspect the meter randomly as per sampling plan for acceptance test as per IS 16444 Part 1. The meters shall be tested for acceptance test as per IS 16444 Part 1

S.No	Description	Units	As Furnished by Bidder
1	Type of meter		
2	Accuracy Class of the meter		
3	Ib & I <sub>max</sub>	A	
4	a. Operating Voltage for meter b. Operating Voltage with communication unit functionality	V	
5	Operating Frequency	Hz	
6	Power Consumption and Burden		
7	Starting Current	mA	
8	Short time over current	A	
9	Influence of heating		
10	Rated impulse withstand voltage	KV	
11	AC withstand Voltage for 1 min	KV	
12	Insulation resistance a) Between frame & Current, voltage circuits connected together: b) Between each current (or voltage circuit) & each and every other circuit.	M ohm	
13	Mechanical requirement as per IS 13779		
14	Resistance to heat and fire (As per specification)		
15	Degree of protection		
16	Resistance against climatic influence (as per IS 13779) - Storage temperature - 25 to 70 Deg as per IS 13779, 2020 (		

S.No	Description	Units	As Furnished by Bidder
	-Operating temperate -10 to 55 Deg as per IS 13779, 2000 ( out door)  Meter OEM to produce data sheet of components, if so required during detailed engineering, from component manufacturers indicating temperature range.		
17	Electromagnetic Compatibility (EMC)		
18	Accuracy requirements (As per IS 13779		
19	Power factor range		
20	Energy measurement		
21	Connection Diagram for system on terminal cover	Yes/No	
22	Self-diagnostic feature		
23	Initial startup of meter (meter shall be fully functional within 5 sec after reference voltage is applied to the meter terminals)		
24	Terminal block		
	a)Depth of the Terminal holes	mm	
	b) Internal diameter of terminal holes	mm	
	c) Clearance between adjacent terminals	mm	
25	Communication capabilities as per clause 1.4.36		
26	Immunity against abnormal Magnetic influence, as defined in Clause 1.4.37		
27	Immunity against ESD as defined in clause 1.4.37		
28	DC Immunity as defined in clause 1.4.38		
29	Abnormal and tamper Conditions as per Table 4 - Tamper Event Details for Single Phase Smart Meters	Yes/No	
30	Grade of material for a) Meter base b) Meter cover c) Terminal block d) Terminal cover		
31	Tamper counts		
32	Recording forward energy in all conditions as per Annexure - 1 (including current/potential reversal)	Yes/No	
33	Makes of all components used in the meter to be provided	Yes/No	
34	Non-Volatile memory (Retention period)		
35	Measuring elements used in the meter		
36	Power supply to circuit in case of supply failure		
37	Display of measured values	Yes/No	
38	LCD display (Type and viewing angle)		



S.No	Description	Units	As Furnished by Bidder
39	Pulse rate	Imp/ kWh,	
40	Name plate marking	Yes/No	
41	Routine test certificates	Yes/No	
42	Acceptance test certificates	Yes/No	
43	Type test certificates	Yes/No	
44	Guarantee certificates	Yes/No	
45	Output Device (LEDs) As per clause Error! Reference source	Yes/No	
46	Make of Disconnecter switch		
47	Disconnecter Technical particular as per Specification clause 1.4.35	Yes/No	
48	Terminal Screw dia.		
49	Allen Screw head size (Terminal Screw)		
50	Fire retardant category of the material a. Meter body b. Terminal block		

## **Annexure B      Technical Specifications for Whole Current A.C. Three Phase Smart Energy Meter**

### ***Scope***

The specification covers the design, manufacturing, testing, supply, and delivery of AC whole current 3 phase 4 wires Smart Energy Meter with bidirectional communication facility suitable for Advanced Metering Infrastructure (AMI) with connect/disconnect switch. The meter shall communicate with Head End System (HES) on any one of the communication technologies mentioned in IS16444 Part 1, as per the requirement of the **MVVNL** / authorized system integrator.

### ***Basic Features***

The Smart Meter would have the following minimum basic features-

- Measurement of electrical energy parameters
- Bidirectional Communication
- Integrated Load limiting switch /relay
- Tamper event detection, recording and reporting
- Power event alarms as per IS 16444 Part 1
- Remote firmware upgrade
- Pre-Paid features at MDM end (as per 15959 part 2)
- TOD feature
- Net Metering(kWh) features (optional as per requirement of **MVVNL**)
- On demand reading

### ***General standards applicable for meters***

<b>S. No.</b>	<b>Standard No.</b>	<b>Title</b>
1	IS 13779 with latest amendments	AC Static Watt-hour Meter class 1& 2
2	IS 15884 with latest amendments	Alternating Current Direct Connected Static Prepayment Meters for Active Energy (Class 1 and 2)- Specification
3	IS 16444 Part 1 with latest amendments	A.C. Static Direct Connected Watt Hour Smart Meter Class 1 and 2- Specification
4	IS 15959 Part 1 & Part 2 with latest amendments	Data Exchange for Electricity Meter Reading, Tariff and Load Control-Companion Standards

### ***Communication***

Meter shall have the ability to communicate with Head End System (HES) on any one of the communication technologies mentioned in IS16444 Part 1 (RF/PLC/ Cellular) in a secure manner. The selection of communication technology should be as per the site conditions and as per design requirement of AMI Implementing agency to meet the performance as per agreed Service Level Agreements (SLAs). In case of Cellular based meter, the meter shall accommodate SIM card/ e-SIM of any service provider. The meter shall log the removal of the plug-in type communication module removal /nonresponsive event with snapshot.

**Remote connect/disconnect/load limiting:** Remote Connect/disconnect/Load control facilities would be as per IS 16444 part 1.

### **Other Specifications**

<b>Features</b>	<b>Minimum requirement of features</b>
Applicable Standards	The meters shall comply with IS 16444 Part 1 for all requirements.
Reference Voltage	As per relevant IS
Current Rating	10-60 A / 20-100 A
Category	UC1
Starting Current	As per IS 16444 Part 1
Accuracy	Class 1.0 as per IS 16444 Part 1
Limits of error	As per IS 16444 Part 1
Operating Temperature range	As per IS 13779
Humidity	As per IS 13779
Frequency	As per IS 16444 Part 1
Influence Quantities	As per IS 16444 Part 1
Power Consumption of meter	As per IS 16444 Part 1
Current and Voltage Circuit	As per IS 16444 Part 1
Running at No Load	As per IS 16444 Part 1
Test output device	As per IS 16444 Part 1
Meter Display	As per IS 16444 Part 1
Name Plate & marking Meter Display	As per IS 16444 Part 1
Parameters to be measured	As per IS 16444 Part 1 / As per IS 15959 Part-2
Maximum Demand resetting	As per IS 15959 Part-2
Time of Use registers	As per IS 15959 Part-2
Power Quality Information	As per IS 15959 Part-2
LED/LCD Indicators	As per IS 16444 Part 1
Load Survey/Interval Data	As per IS 15959 Part-2
Tamper/ Event Recording	As per IS 15959 Part-2
Measuring Elements	As per Is 16444 Part 1
Alarm	As per IS 16444 Part 1 / As per IS 15959 Part-2
Load Control	As per IS 16444 Part 1
Connect/Disconnect switch	UC1 as per IS 16444 Part 1
Status of Load switch	As per IS 16444 Part 1
Programmability	As per IS 16444 Part 1
Communication	As per IS 16444 Part 1
Communication Protocol	As per IS 16444 Part 1
Remote Firmware upgrade	As per IS 15959 Part-2

Features	Minimum requirement of features
Real Time Clock (RTC)	As per IS 16444 Part 1 / IS 15959 Part 1 & Part 2
Data Retention	As per IS 16444 Part 1
Battery Backup	Meter shall be supplied with adequate separate battery backup for RTC.
First Breath (Power on) and Last gasp (Power off) condition detection and communication to HES	As per IS 16444 Part 1
Plug-in Communication Module	The Smart Meters shall have a dedicated sealable slot for accommodating plug-in type bi-directional communication module which shall integrate the respective communication technology ( RF/PLC/ Cellular) with the Smart Meters, leading to easy adaptability for network interfaces (WAN/NAN).The Plug-In module shall be field swappable/ replaceable.

***Data display facility (auto/manual)***

As per IS 16444. However minimum requirement should include the following:

Data Display shall be in two modes-

1. Auto Scroll
2. Scroll with Push Button

The display parameters shall be:

- Auto Scroll
  - Display Check
  - Date and Time
  - Last Recharge Amount
  - Last Recharge Time
  - Current Balance Amount
  - Current Balance time
  - Cumulative Active Energy kWh with legend.
  - Cumulative Apparent Energy kVAh with legend.
  - Current month MD in kW with legend.
  - Current month average Power Factor
  - Instantaneous voltage  $V_{RN}$
  - Instantaneous voltage  $V_{YN}$
  - Instantaneous voltage  $V_{BN}$
  - Instantaneous current  $I_R$
  - Instantaneous current  $I_Y$
  - Instantaneous current  $I_B$
  - Instantaneous current  $I_N$
  - Instantaneous Load kW and kVA
  - Instantaneous average Power Factor

These parameters should be displayed on the LCD/LED continuously for a period of 10 seconds

on Auto scroll.

- Scroll with Push-button

All Parameters mentioned under Auto-Scroll mode should be displayed. Additionally, the following Parameters shall also be displayed:

- Internal diagnostics (display check)
- Meter Serial No
- Cumulative Energy in kVAh Lag/ Lead with legend
- Cumulative Active Energy kWh ToD wise with legends.
- Cumulative Apparent Energy kVAh ToD wise with legends.
- Current month MD in kVA with legends
- Last month cumulative kWh with legends
- Last month cumulative kVAh with legends
- Last month MD in kW with legends
- Last month Average Power Factor

Further, the Meter should display High Resolution energy values with resolution of 3 digits before decimal and 2 digits after decimal in push button mode.

The meter's display should return to default display mode (continues auto scroll) if push button is not operated for more than 10 seconds. (The order of display may be as per the requirement of **MVVNL**). Meter display should not go in to sleep mode during Power-On condition.

#### ***Anti-tamper features***

The meter shall continue working under tamper conditions as defined in IS 15959 Part 2 and would log the event and send alarm at Head End System after detection of the defined tamper features as per IS 15959 Part 2.

#### ***Type Tests & Test Certificates***

Smart Meter shall be type tested for tests as per relevant parts of IS 16444 (latest versions) and certified by Indian Standard wise list of BIS recognized labs as available at <https://bis.gov.in/index.php/laboratorys/list-of-bis-recognized-lab/>. The number of sampling for testing of meters and criteria for conformity would be as per IS 16444(as amended up to date). Necessary copies of test certificates shall be submitted as per agreement with the **MVVNL**.

#### ***Routine & Acceptance Tests***

The Factory Acceptance and Routine tests shall be carried out as per IS 16444 Part 1.

#### ***General & Constructional requirements***

Meter shall be BIS marked as per IS 16444 Part 1. General & construction requirement shall be as per IS 16444/IS 13779

***Meter base & cover*** - Meter base & cover shall be as per IS 16444 Part1 / IS 13779. The meter Base & cover shall be 'Break to open' design. The material for meter base and cover shall be made of high-grade polycarbonate.

The meter Base & cover shall be ultrasonically welded / Chemically welded or other suitable bonding technology and it will not be possible to remove the cover from the base without evidence of damage

**Terminal block & cover** - As per IS 16444 Part 1/IS 13779

**Design**

Voltage circuit, sealing arrangement, terminal block, terminal cover and nameplate etc. shall be in accordance with IS-16444 Part 1 (latest version). The meter shall be compact and reliable in design, easy to transport and immune to vibration and shock involved in transportation and handling

**Name plate and marking**

The meter should bear a name plate clearly visible, effectively secured against removal and indelibly/distinctly marked in accordance with relevant IS. In addition, “Name of the **MVVNL**”, purchase order no. & year/month of manufacturing shall be provided on the meter name plate. The rating plate information shall be as per relevant IS.

**Connection diagram:** As per IS 16444 Part 1

**Fixing arrangements:**

The meter shall be mounted type. The Meter should have three fixing holes, one at top and two at the bottom. The Top hole should be such that the holding screw is not accessible to the consumer after fixing the meters. The lower screws should be provided under sealable terminal cover. The requisite fixing screws shall be supplied with each meter.

**Sealing arrangement:**

Arrangements shall be provided for proper sealing of the meter cover so that access to the working parts shall not be possible without breaking the seal. The sealing arrangement and number of seals shall be as per relevant IS/ requirement of **MVVNL**.

**Meter box:**

The Meter Box if required, would be provided as per requirement of the **MVVNL**/ purchaser and the material of the Meter Box should be such that it does not hamper communications.

**Packing**

- The meters shall be suitably packed for vertical/horizontal support to withstand handling during transportation.
- The meter shall be packed appropriately to ensure safe transportation, handling, identification and storage.
- All packing materials shall be as per environment law in force. The primary packing shall ensure protection against humidity, dust, grease and safeguard the meter’s performance until its installation.
- The secondary packing shall provide protection during transportation.
- The packing case shall indicate “Fragile in nature” and direction of placement of box.
- The packing shall indicate marking details like Manufacturer’s name, meters #s, quantity, etc.

**Transportation**

- The meter shall be compact in design. The meter block unit shall be capable of withstanding stresses likely to occur in actual service and rough handling during transportation.
- The meter shall be convenient to transport and immune to shock and vibration during transportation and handling.

- The meter should not be exposed to undue shock and mishandling during transportation.
- The stacking of box inside transport media should be such as to avoid their free movement.
- The packing should also be protected from rain and dust by transport media.
- The AMISP shall be responsible for any damage during transit due to inadequate or improper packing.

***Testing and Manufacturing Facilities at Manufacturer's Place***

The manufacturer shall have facilities of conducting Acceptance Testing as per IS 16444 Part 1.

***Inspection***

- The meters shall be sealed as per the mutual agreement of the supplier and the purchaser
- The **MVVNL**/ purchaser may inspect the meter randomly as per sampling plan for acceptance test as per IS 16444 Part 1. The meters shall be tested for acceptance test as per IS 16444 Part 1

## **Annexure C Three phase CT operated alternating current Smart Meter of Accuracy Class 0.5S (DT Meter, LT-CT Meter, etc.)**

### **C.1 General Standards Applicable for Meter**

Unless otherwise specified elsewhere in this specification, the performance and testing of the meters shall conform to the following standards and amendments/revisions thereof.

<b>Sl. No.</b>	<b>Standard No.</b>	<b>Title</b>
1	IS 16444: Part 2 with latest amendments	AC Static Transformer Operated Watt-hour and VAR-Hour Smart Meters, class 0.2S, 0.5S and 1S
2	CBIP- Publication 325 with latest amendments	Standardization of AC Static Electrical Energy Meters
3	CBIP Technical report no. 111 with latest amendments	Specification for Common Meter Reading Instrument
4	IS:9000 with latest amendments	Basic Environmental Testing Procedures for Electronic & Electrical Items.
5	IS 12063 with latest amendments	Degrees of protection provided by enclosures of electrical equipment.
6	IS 14451, Part-2: 1999 with latest amendments	Telemetry for consumption and demand. Direct digital transfer of meter values.
7	IS 4905: 1999 with latest amendments	Methods for Random sampling.
8	IS 12346 with latest amendments	Specifications for Testing Equipment for AC Energy meter.
9	IS 15959 Part 3 (as applicable) with latest amendments	Data exchange for electricity meter reading, tariff and load control: Companion specification

### **C.2 Communication**

Meter shall have ability to communicate with HES on any one of the technologies mentioned in IS 16444 (RF/Cellular/PLC) in a secure manner. The selection of communication technology should be as per the site conditions and as per design requirement of the AMISP to meet the Service Level Agreements (SLAs). In case of cellular based meter, the meter shall accommodate SIM Card / e-SIM of any service provider. The meter shall log the removal of the plug-in type communication module removal /nonresponsive event with snapshot.



### C.3 Other Specifications

Particulars	Specifications
Applicable Standards	The meters shall comply with IS 16444: Part2 for all requirements except for those parameters which have been specifically mentioned to be otherwise in this specification.
Reference Voltage	[As per relevant IS]
Current Rating	Ib 5A
Starting Current	As per IS 16444: Part2
Accuracy	Class 0.5S as per IS 16444: Part 2
Limits of error	As per IS 16444: Part 2
Operating Temperature range	As per IS 16444: Part 2
Humidity	As per IS 16444: Part 2
Frequency	As per IS 16444: Part 2
Influence Quantities	As per IS 16444: Part 2
Power Consumption of meter excluding communication module	As per IS 16444: Part 2
Current and Voltage circuit	As per IS 16444: Part 2
Running at No Load	As per IS 16444: Part 2
Test output device	As per IS 16444: Part 2
Meter Display	As per IS 16444: Part 2
Time of Use (In case of net-meter both export & import parameters to be measured)	As per IS 15959: Part 3 (as applicable)
Parameters to be measured	As per IS 16444: Part 2 / IS 15959: Part 3 (as applicable)
Power Quality Information	As per IS 15959: Part 3 (as applicable)
Maximum Demand	As per IS 15959: Part 3 (as applicable)
Load Survey/Interval Data	As per IS 15959: Part 3 (as applicable)
LED/LCD Indicators	As per IS 16444: Part 2
Tamper/Event recording	As per IS 15959: Part 3 (as applicable)
Alarm	As per IS 16444 / IS 15959: Part 3 (as applicable)
Measuring Elements	As per IS 16444: Part 2

Particulars	Specifications
Anti-Tamper features	The meter shall continue working under tamper conditions as defined in IS 15959 Part 3 and would log the event and send alarm at HES after logging of the defined tamper features as per IS 15959 Part 3.
Programmability	As per IS 16444: Part 2
Communication	As per IS 16444: Part 2
Communication Protocol	As per IS 15959: Part 3 (as applicable)
Real time clock (RTC)	As per IS 16444: Part 2 / IS 15959: Part 3 (as applicable)
Data Retention	As per IS 16444: Part 2
Battery Backup	Meter shall be supplied with separate battery backup for RTC.
Data display facility (manual/Auto)	<p>As per IS 16444: Part 2 (as applicable)</p> <p>However minimum requirement should include the following:</p> <p>Data Display shall have following features:</p> <ul style="list-style-type: none"> <li>• High Resolution (Shall display energy values with resolution of 2 digits before decimal and 3 digits after decimal.</li> <li>• The Push button for manual scrolling in addition to auto scrolling with a persistence time of 10 seconds for each parameter shall be provided.</li> </ul> <p>Display of data as per <b>IS 16444 (Part 2)</b></p>
Remote Firmware Upgrade	As per IS 15959: Part 3 (as applicable)
Digital Input (DI)	<p>The Smart meter should have the provision of sensing digital inputs via DI (Digital Input) port provided at the terminal block. The smart meter should register the digital input(s) sensed, upon reaching respective threshold (configurable) and the event shall be communicated to HES. The OBIS code required for this shall be provided during detailed engineering.</p> <p>The requisite power supply requirement (AC to DC auxiliary supply/ charger) for the DI should be made internal to the smart meter itself. In case the same is not feasible to be provided, bidder should provide external power supply with following specifications.</p> <p>d) Input voltage: 63.5V AC  e) Operating voltage: 12V DC  f) Contact Rating: 5A Continuous @30V DC, 25A for 3 sec</p> <p>No. of DIs - 04 Nos. DI for 4V(DC), 10 mA</p>

**Annexure D Three phase CT/PT operated alternating current Smart Meter of Accuracy Class 0.5S/ 0.2S (as required) –Feeder Meter, Boundary Meter, HT Consumers, etc.**

**D.1 General Standards Applicable for Meter**

Unless otherwise specified elsewhere in this specification, the performance and testing of the meters shall conform to the following standards and amendments/revisions thereof.

Sl. No.	Standard No.	Title
1	IS 16444: Part 2 with latest amendments	AC Static Transformer Operated Watt-hour and VAR-Hour Smart Meters, class 0.2S, 0.5S and 1S
2	CBIP- Publication 325 with latest amendments	Standardization of AC Static Electrical Energy Meters
3	CBIP Technical report no. 111 with latest amendments	Specification for Common Meter Reading Instrument
4	IS:9000 with latest amendments	Basic Environmental Testing Procedures for Electronic & Electrical Items.
5	IS 12063 with latest amendments	Degrees of protection provided by enclosures of electrical equipment.
6	IS 14451, Part-2: 1999 with latest amendments	Telemetry for consumption and demand. Direct digital transfer of meter values.
7	IS 4905: 1999 with latest amendments	Methods for Random sampling.
8	IS 12346 with latest amendments	Specifications for Testing Equipment for AC Energy meter.
9	IS 15959 Part 3 (as applicable) with latest amendments	Data exchange for electricity meter reading, tariff and load control: Companion specification

**D.2 Communication**

Meter shall have ability to communicate with HES on any one of the technologies mentioned in IS 16444 (RF/Cellular/PLC) in a secure manner. The selection of communication technology should be as per the site conditions and as per design requirement of the AMISP to meet the Service Level Agreements (SLAs). In case of cellular based meter, the meter shall accommodate SIM Card / e-SIM of any service provider. For installation on Feeders, if cellular, the meter shall accommodate dual SIM Card / e-SIM of any service provider/multinetwork or dual-profile SIM. The meter shall

log the removal of the plug-in type communication module removal /nonresponsive event with snapshot.

### D.3 Other Specifications

Particulars	Specifications
Applicable Standards	The meters shall comply with IS 16444: Part2 for all requirements except for those parameters which have been specifically mentioned to be otherwise in this specification.
Reference Voltage	[As per relevant IS]
Current Rating	Ib 5A/ 1A (as applicable)
Starting Current	As per IS 16444: Part2
Accuracy	Class 0.5S or 0.2S as per IS 16444: Part 2
Limits of error	As per IS 16444: Part 2
Operating Temperature range	As per IS 16444: Part 2
Humidity	As per IS 16444: Part 2
Frequency	As per IS 16444: Part 2
Influence Quantities	As per IS 16444: Part 2
Power Consumption of meter excluding communication module	As per I S 16444: Part 2
Current and Voltage circuit	As per IS 16444: Part 2
Running at No Load	As per IS 16444: Part 2
Test output device	As per IS 16444: Part 2
Meter Display	As per IS 16444: Part 2
Time of Use (In case of net-meter both export & import parameters to be measured)	As per IS 15959: Part 3 (as applicable)
Parameters to be measured	As per IS 16444: Part 2 / IS 15959: Part 3 (as applicable)
Power Quality Information	As per IS 15959: Part 3 (as applicable)
Maximum Demand	As per IS 15959: Part 3 (as applicable)
Load Survey/Interval Data	As per IS 15959: Part 3 (as applicable)
LED/LCD Indicators	As per IS 16444: Part 2
Tamper/Event recording	As per IS 15959: Part 3 (as applicable)
Alarm	As per IS 16444 / IS 15959: Part 3 (as applicable)
Measuring Elements	As per IS 16444: Part 2

Particulars	Specifications
Anti-Tamper features	The meter shall continue working under tamper conditions as defined in IS 15959 Part 3 and would log the event and send alarm at HES after logging of the defined tamper features as per IS 15959 Part 3.
Programmability	As per IS 16444: Part 2
Communication	As per IS 16444: Part 2
Communication Protocol	As per IS 15959: Part 3 (as applicable)
Real time clock (RTC)	As per IS 16444: Part 2 / IS 15959: Part 3 (as applicable)
Data Retention	As per IS 16444: Part 2
Battery Backup	Meter shall be supplied with separate battery backup for RTC.
Data display facility (manual/Auto)	<p>As per IS 16444: Part 2 (as applicable)            However minimum requirement should include the following:            Data Display shall have following features:</p> <ul style="list-style-type: none"> <li>• High Resolution (Shall display energy values with resolution of 2 digits before decimal and 5 digits after decimal.</li> <li>• The Push button for manual scrolling in addition to auto scrolling with a persistence time of 10 seconds for each parameter shall be provided.</li> </ul> <p>Display of data as per <b>IS 16444 (Part 2)</b></p>
Remote Firmware Upgrade	As per IS 15959: Part 3 (as applicable)
Digital Input (DI)	<p>The Smart meter should have the provision of sensing digital inputs via DI (Digital Input) port provided at the terminal block. The smart meter should register the digital input(s) sensed, upon reaching respective threshold (configurable) and the event shall be communicated to HES. The OBIS code required for this shall be provided during detailed engineering.</p> <p>The requisite power supply requirement (AC to DC auxiliary supply/ charger) for the DI should be made internal to the smart meter itself. In case the same is not feasible to be provided, bidder should provide external power supply with following specifications.</p> <ol style="list-style-type: none"> <li>a) Input voltage: 63.5V AC</li> <li>b) Operating voltage: 12V DC</li> <li>c) Contact Rating: 5A Continuous @30V DC, 25A for 3 sec</li> </ol> <p>No. of DIs - 04 Nos. DI for 4V(DC), 10 mA</p>

**Annexure E      System Sizing Requirement****E.1 Sizing Parameter**

The system shall be designed as per the technical parameters defined in this specification and as specified in this Annexure.

The AMI system (MDM, Historian, NMS etc.) shall be suitably sized based on expansion requirements mentioned in Article 14 of Section 7.

CSP should offer auto-scaling of the compute resources based on the defined threshold of resource utilization. There should be a minimum and maximum limit defined for auto-scaling for a workload.

This memory utilization includes the memory used for storage of data (including expansion requirement defined in above para) for the defined duration as specified in the Technical Specification. The system architecture and the network design shall have the ability to handle the growth with respect to functions, and user as defined.

## Annexure F General requirement for common pluggable communication module for Smart Meters

Considering that the new Smart Meters may use different types of communication technologies (RF/PLCC/Cellular, etc.), thus in order to enable different communication modules to be used in the same meter, it is necessary to use a universal interface and a particular size irrespective of the choice of communication technology that defines the dimensions of the communication slot as well as physical placement and location of connectors. The following example recommendations will go a long way in assuring interoperability whilst still complying with the provisions of IS 16444 and IS 15959 standards:

### Part I

#### 1. Recommended Module Placement location

- In order to improve the Radio Performances of any of the wireless technologies encompassing but not limited to Cellular, RF and / or RF mesh, it is recommended to place the communication module anywhere on the accessible part of the meter. This will also enable an easy approach to improve antennae performances.
2. Meter shall have the means of tamper detection to record the event(s) of the removal of the communication module set from the meter, irrespective of whether the meter is in power on (has supply) or powered off (no supply) condition.
  3. The Module shall be hot swappable and shall fit snugly inside the meter box, so that the same IP class of the meter is maintained.
  4. A transparent cover may be used for the purpose,
    - a. To have a sealing arrangement with the meter body as well as
    - b. For easy viewing of LED indicators and antenna assembly without having to open the cover.

### Part II

#### AC power interface:

In the event of PLC communication being chosen as the only or one of the choices, the following arrangement of connector and pinouts need to be provisioned on the communication module.

#### Female connector

1. Front View:

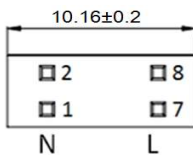

Single phase meter

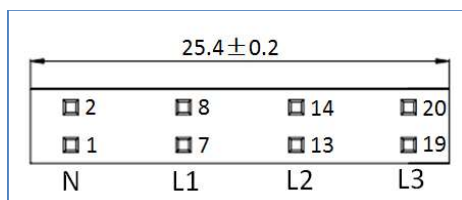

Poly phase meter

2. Top View:

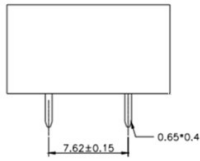

Single phase meter

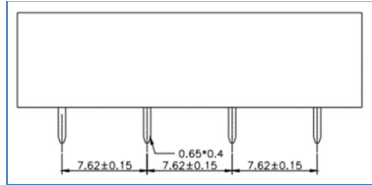

Poly phase meter

3. Side View:

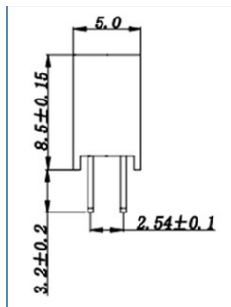

Pin to Pin distance should be: 7.62mm (Standard Pin connector)

**Communication interface:**

The meter shall have a slot of an appropriate size to allow for the pluggable communication module (such as but not limited to NAN /WAN, dual mode RF, Dual Technology, cellular etc.) to be fit in to the meter. The meter shall provide a 14-pins Female socket connector (2\*7pin, 2.54mm). The socket shall be selected and positioned to ensure that the male pins on the communication module can connect reliably and easily connect with the female contactors on the meter.

**Female connector**

1. Front View :

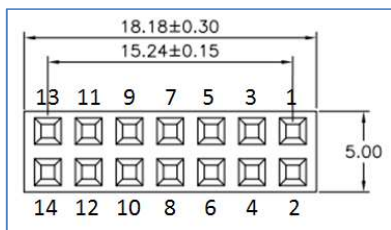

2. Top View:



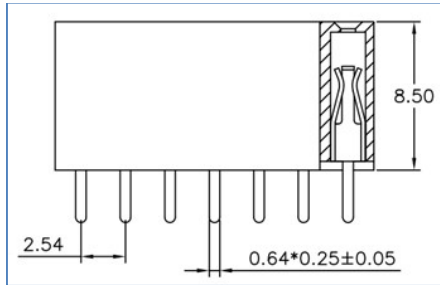

### 3. Side View:

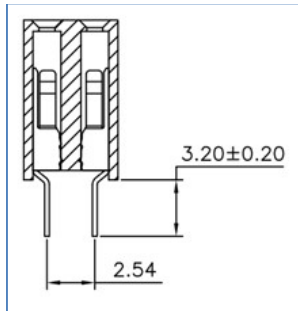

**PIN Outs may be provided as per below details**

Pin No	Name	Input/output	Description
1	Reserved	/	/
2	Reserved	/	/
3	Power EN	Output	Control the module's power supply
4	Reserved	/	/
5	Reserved	/	/
6	Meter TXD	Output	To Module UART port RXD, Min.38400
7	Meter RXD	Input	From Module UART port TXD, Min.38400
8	Reserved	/	/
9	RTS	Input	Input digital signal from module
10	RST	Output	Reset signal for module
11	CTS	Output	Output digital signal to module
12	+Vdc	Power	As per IS16444
13	GND	Common	Ground Reference Potential
14	GND	Common	Ground Reference Potential

### Part III

The following reference size may be adhered to irrespective of a single or multiple communication options provisioned on the same module. This standard form factor and dimensions will enable physical and functional interoperability with different makes of meters.

#### A. Module 3-D views (For Representational Purpose Only)

1. Module in meter (Top View)

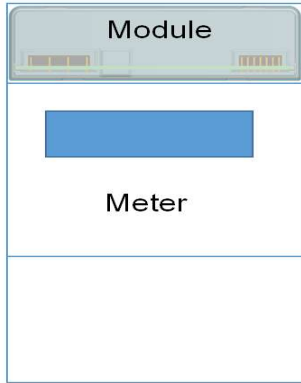

2. 3D View

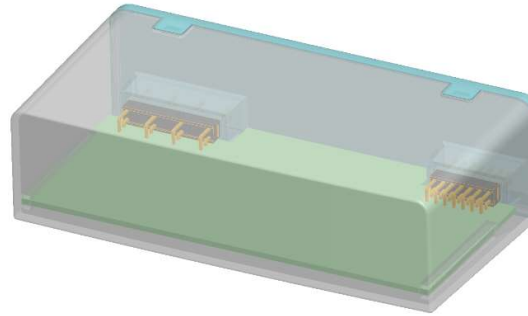

3. Front View



4. Back View

5. Side View



6. Top View



7. Bottom View



## B. Module Dimensions

Overall view of the module:

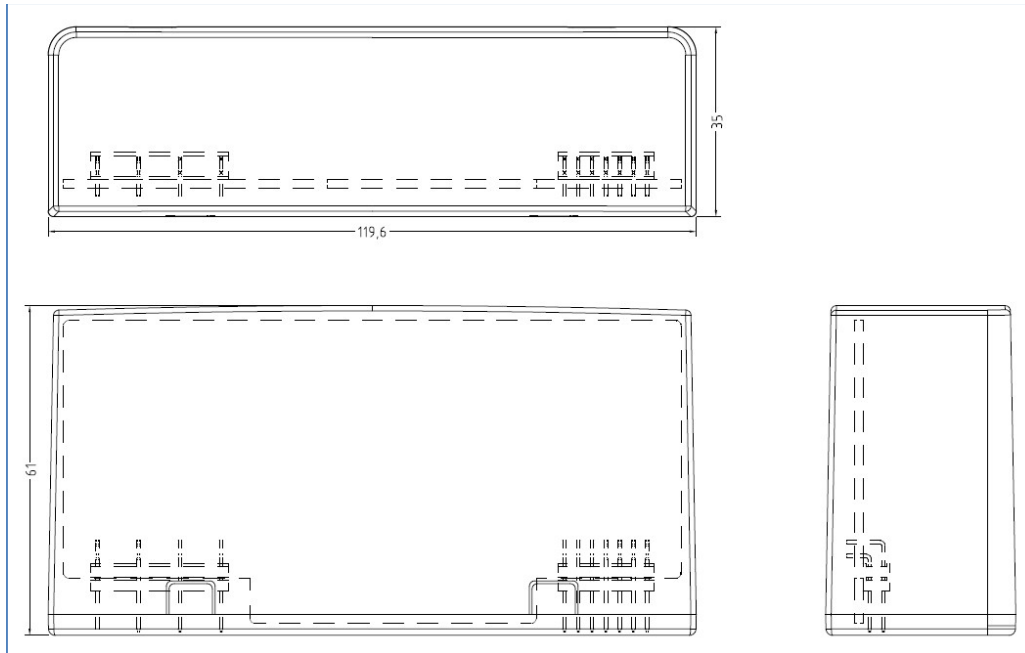

Overall view of the module's PCBA:

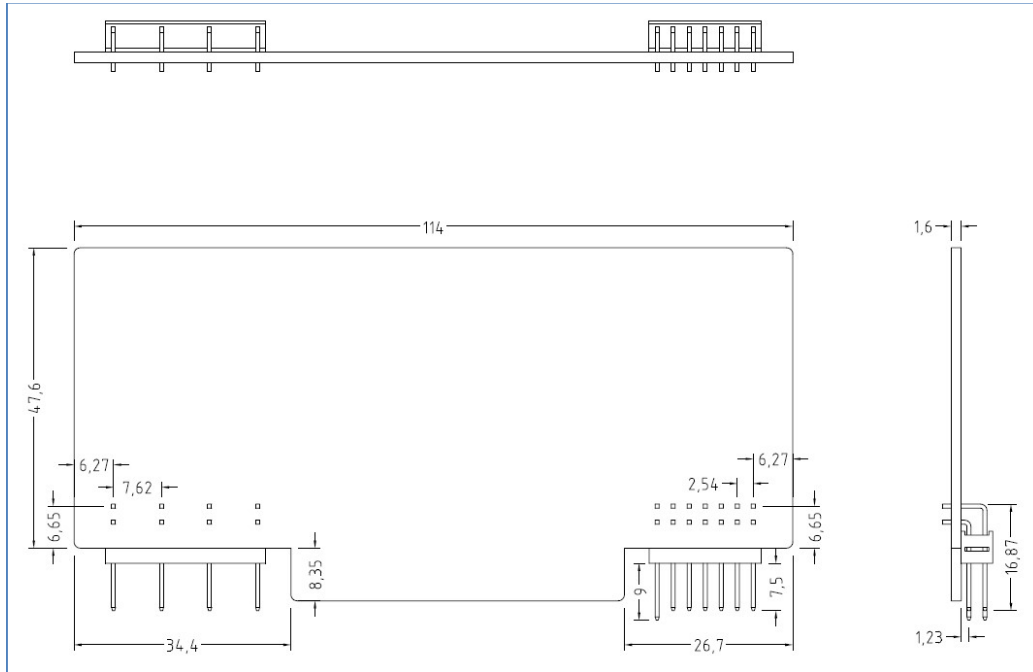

**Notes: Module Reference Sizes: unit mm.**

---

**Annexure G      Details of ESB Architecture**

S. No.	Parameters	Description
1	Architecture Design	
2	Core Functionalities	
3	Implementations	

### Annexure H Future Demand Response Program Use Cases for Reference

The objective of the Demand Response is to optimal utilization of energy resources by uniform distribution of load across the day, to save additional investment in capacity addition within the **MVVNL**, improved access of power to rural areas, reduction in technical losses, enhanced consumer satisfaction by load curtailment in place of load shedding.

S. No.	Functional requirement	Description of Functional requirement
1.	Load Curtailment event in place of Load Shedding	System will determine based on day ahead schedule for available generation capacity and load forecasting the load curtailment events. Advance notice will be sent to a group of consumers affected by this load curtailment. DR system will send the load curtailment command to the MDM. The MDM will forward this command to the appropriate AMI Head-End.
2.	DR Program Commencement	Once the consumer is set up with all the devices necessary, the consumer details will be sent to DR system. Premium charges for assured power supply with SLA and/or Rebates and incentives can be given to consumers who participate in DR programs.
3.	Real time Pricing	<b>MVVNL</b> shall be able to send real-time pricing signals to end consumers/ AMI system
4.	Curtailment due to Contract Violation	<b>MVVNL</b> limits consumer's load due to reasons like exceeding contract load Alarms (visual and audio) shall be provided in case of load violation (in home device, Email, SMS etc.). The billing system shall be notified of the load violation, and the corresponding charges shall be applied to consumer (based on tariff rules).
5.	Demand side Management	In every 15-minute interval Meter data should be captured, Confirmation of action taken for demand response should be mentioned as well as monitoring of historical Consumer Load Profile should be done.
6.	Load Monitoring at Demand side	Daily Meter Reading, Status and associated details capturing for records of consumer consumption data, TOU details, real time trends and Load profile Details. Along with this whenever there is a load violation event recorded in the meter, the information is sent to the control center
7.	Initiate Direct Load Control Event	<b>MVVNL</b> calls a Direct Load Control Event using the Peak Load Management (PLM) Application and executes through head-end by sending a load control signal to Smart Appliances thru HAN/Smart Meter or other means
8.	Energy accounting system	<b>Register and Interval based accounting:</b> <b>Register based</b> Register based accounting supports requirements for prepaid energy accounting based on register reads. It includes billing cycle data services that deliver billing determinants via an interface to CIS/Billing on the billing cycle date and on request when special reads are required. A Billing Determinant Calculator provides the flexibility to compute the billing determinant values based on <b>MVVNL</b> defined formulas. Formulas are built around logical and arithmetic operators, and can contain other billing determinants, constants, and consumer functions. <b>Bi-directional</b> MDM should support bi-directional metering by processing the

S. No.	Functional requirement	Description of Functional requirement
		<p>delivered and received channels for a given meter in two separate channels.</p> <p><b>Net Metering</b> (using Virtual channel) MDM should support net metering by processing the delivered and received channels from the meter/recorder and calculating a net amount. The calculated net will be stored onto a virtual channel. MDM should provide full tracking, management, and storage of usage data related to each data channel. This allows summation of usage data separately for each data channel.</p> <p><b>Usage Calculated from Register Reads</b> MDM can create usage data from register reads received from AMI systems or gathered manually through HHUs. MDM will calculate the difference between the current bill period register read and the previous bill period register read, applying the ratio required converting to the correct kWh usage. Rollover conditions are also considered when computing usage. The calculated usage is stored in the billing table and accessible to all applications that require the data.</p> <p><b>Interval Billing:</b> The Interval Billing should include all of the functionality offered in the Register Billing in addition to support Advanced Billing Determinants (ABD) calculated from interval reads. As interval data is retrieved by the AMI systems, the Advanced Billing Determinant (ABD) engine should process the interval reads into daily and billing cycle usage-based billing determinants (as compared to register-based billing). For example, if 15 min interval data is retrieved by the system, MDM calculates the proper billing determinant which is based on RTP/ Time-of-Use (TOU) tariff, then ABD engine will make this computation based on tariff configuration data in the database. Then it stores this daily data set (RTP/TOU values with usage details for each), along with the interval data in the Metered Usage Data Repository (MUDR). On each billing cycle, the ABD engine will summarize the RTP/TOU and demand data for each period over the requested billing span and deliver these billing determinants to the billing system. By performing the billing determinant summations daily, MDM support end-user presentation of "month-to-date" information as well as spread computational loads over time (including weekends).</p>

**Annexure I      Conditions/protocols for auto-disconnections**

*<These conditions/ protocols should be reviewed and updated by utilities as per their requirement>*

- a) *<MUVNL to mention for which consumer categories would the protocol for auto-disconnections shall apply and for which consumer categories the same shall not be applicable.>*
  
- b) The auto-disconnection shall not be allowed during gazetted holiday / national holidays and during night-time



**Annexure J AMI system availability**

AMI system issues and availability are flagged at three different severity levels.

- a) Severity 1 is the most critical being a complete system level failure or breach of IT policies and requiring urgent and immediate attention.
- b) Coverage under severity 2 are outages that do not cause any immediate disruption but subsequently may result into severity 1 outage.
- c) Severity 3 are those issues / problems / outages which are neither of an emergency nor priority level as grouped under severity level 1 or 2.

The AMISP shall implement an appropriate online SLA Application (as elaborated in Clause 7.7 of this Section) for problem/defect reporting and tracking system. This would enable logging and tracking of outages / defects/non-conformances of all severity levels and get the approval of the same from the **MVVNL** towards desired resolution. The incidents (15 in number) are categorized as mentioned in below table.

Category	Incident Description <sup>5</sup>
Severity 1 – Urgent	<ol style="list-style-type: none"> <li>a) Complete loss of AMI system functions<sup>6</sup></li> <li>b) Partial outage of AMI functions               <ol style="list-style-type: none"> <li>i. <b>MVVNL</b> user interface</li> <li>ii. Consumer portal</li> </ol> </li> <li>c) Stoppage of data backup at DC/DR (refer Clause ‘7.3.1 e’ of this Section)</li> <li>d) Cyber Security issues leading to unauthorized access to systems/applications</li> </ol>
Severity 2 – Serious	<ol style="list-style-type: none"> <li>a) Outage at Network Operation cum Monitoring Centre               <ol style="list-style-type: none"> <li>i. Complete outage of communication connectivity</li> <li>ii. Failure of UPS system</li> <li>iii. Failure of Battery / other auxiliary system)</li> </ol> </li> <li>b) Interruption of data exchange with <b>MVVNL</b> enterprise systems</li> <li>c) Partial outage of AMI functions               <ol style="list-style-type: none"> <li>i. Outage of VEE</li> <li>ii. Billing Determinants</li> <li>iii. Reports</li> </ol> </li> <li>d) Breach of data privacy</li> <li>e) Adherence to RPO / RTO<sup>7</sup> as per Clause 2.7.3.3.9 of this Section and as mentioned in Clause 7.3.1 of this Section</li> </ol>

<sup>5</sup> Please note that the table provides the different incidents categorized under different severity levels. If any incident at a higher severity level or order is active, then it shall be understood that a new incident at a lower severity level or order linked to the one at the higher-level incident, shall not be separately registered. For instance, when there is an incident “Complete Outage of AMI system functions” under Severity-1, then “Partial outage of AMI functions” or “Interruption of data exchange with utility enterprise systems” shall not be registered.

<sup>6</sup> A complete outage of AMI functions may happen due to a system level crash or outage of DC/DR infra or outage of MPLS bandwidth at DC/DR

<sup>7</sup> RTO and RPO are expected to be checked once a month for purpose of SLA

Category	Incident Description <sup>5</sup>
Severity 3 – Minor	<ul style="list-style-type: none"> <li>a) Non-availability of reports as per Clause 6.2 of this Section during the Operation Phase</li> <li>b) Resolution of complaint ticket raised and passed on by CCS [These complaints shall be registered within the SLA Application and hence shall have to undergo mutual agreement checks between MVVNL/AMISP before being registered for resolution]</li> <li>c) Non-availability of required inventory of spares specified in Clause 7.3.3 of this Section</li> <li>d) Failure of workstation, printers, LAN etc. at the NOMC</li> <li>e) Non-availability of designated AMISP's Manpower at the NOMC</li> </ul>

### J.1 Response & Resolution Time

The target times within which the AMISP should respond to support requests for each category of severity is described in the following table.

- a) The Initial Response Time is defined as the period from the initial logging of the support request (through established systems and/or communications channels) and the acknowledgment of the AMISP subject to the maximum time defined in the following table. In case, AMISP doesn't respond within initial response time, the support shall be deemed acknowledged by the AMISP.
- b) The Action Resolution Time is the period from the acknowledgement of support request to the AMISP delivering a solution subject to the Maximum time defined in following table.
- c) The Action Resolution Time includes investigation time and consideration of alternative courses of action to remedy the situation.

Severity	Initial Response Time	Maximum Action Resolution Time	Action
1	[15 minutes]	[2 hours]	An urgent or emergency situation requiring continuous attention from necessary support staff until system operation is restored.
2	[30 minutes]	[24 Hours]	Attempt to find a solution acceptable to the MVVNL (dependent on reproducibility), as quickly as practical.
3	[2 hours]	[10 days]	Evaluation and action plan. Resolution time is dependent on reproducibility, ability to gather data, and the MVVNL's prioritization.

### J.2 Service Response Requirements

Emergency Support for Severity 1 issues are to be provided 24 hours a day, seven days a week. The on-call support team shall include all key technical competencies so that any aspect of a

system failure can be attended to. Severity 1 issues shall be reported by telephone for rapid response; the key objective is to restore the system to an operational state as quickly as possible.

### J.3 System Availability Calculations

System level issues / availability calculation methodology shall be as below:

- a) For Severity-1 and 2 level incidents, the non-availability hours for availability calculation shall be counted from the end of the allowed Action Resolution time for their first instance in a given month. If any incident, repeats in the same month, the non-availability hours for availability calculation shall be counted from the end of allowed Initial Response Time.
- b) For Severity-3 events, the non-availability hours for availability calculation shall be counted from the end of the allowed Action Resolution time

A standardized online ticket register shall be maintained, that shall be made available to **MVVNL** online, containing the following:

Details of each issue reported:

- a) Actions taken by AMISP to correct the issue
- b) Applicable Severity level
- c) Time of reporting to the AMISP support engineer/support
- d) Actual vs Allowed response & resolution time as defined in this annexure
- e) Review of **MVVNL**'s Engineer-in-charge as well as the AMISP's support engineer of the site.

In the event of multiple failures at a site, due to a common cause, the first FPR (Field Problem, Report) logged shall be used for the purpose of system availability calculation. However, simultaneous multiple outages due to unrelated cause would be counted separately.

Availability computation shall be done on monthly basis in selected area(s) of operation. The formula to be used for availability computation shall be as under:

$$\text{Availability per month} = \frac{\text{THM} - (S1 \times 1 + S2 \times 0.8 + S3 \times 0.5)}{\text{THM}}$$

- Where THM is total hours in the month when power supply to AMI system is available
- S1/ S2/ S3 is the total non-available hours in Severity Level-1 /2/3

S1/ S2/ S3 are computed for each event. For instance, S3 for each Severity-3 event would be number of hours passed beyond the maximum resolution time for which the event is not resolved. Some examples for the same are provided below

Category	Example of computing non-available hours
Severity 1 – Urgent	<p>For incidents happening for the first time in the month, Number of hours beyond the allowed maximum resolution time for which:</p> <ul style="list-style-type: none"> <li>a) Complete loss of AMI system functions</li> <li>b) Partial outage of AMI functions <ul style="list-style-type: none"> <li>i. MVVNL user interface</li> <li>ii. Consumer portal</li> </ul> </li> <li>c) Cyber security issues remain unresolved</li> <li>d) Data backup at DC/DR remains stopped</li> </ul> <p>For incidents happening for the second or more times in the month, Number of hours beyond the allowed initial response time for which:</p> <ul style="list-style-type: none"> <li>a) Complete loss of AMI system functions</li> <li>b) Partial outage of AMI functions <ul style="list-style-type: none"> <li>i. MVVNL user interface</li> <li>ii. Consumer portal</li> </ul> </li> <li>c) Cyber security issues remain unresolved</li> <li>d) Data backup at DC/DR remains stopped</li> </ul>
Severity 2 – Serious	<p>For incidents happening for the first time in the month, Number of hours beyond the allowed maximum resolution time for which:</p> <ul style="list-style-type: none"> <li>a) Outage at Network Operation cum Monitoring Centre <ul style="list-style-type: none"> <li>i. Complete outage of communication connectivity</li> <li>ii. Failure of UPS system</li> <li>iii. Failure of Battery / other auxiliary system)</li> </ul> </li> <li>b) Partial outage of AMI functions <ul style="list-style-type: none"> <li>i. Outage of VEE</li> <li>ii. Billing Determinants</li> <li>iii. Reports etc.</li> </ul> </li> <li>c) Any single event on data privacy breach is not resolved</li> <li>d) Interruption of data exchange with MVVNL enterprise systems remains unresolved</li> <li>e) Adherence to RPO / RTO is not ensured</li> </ul> <p>For incidents happening for the second or more times in the month, Number of working hours beyond the allowed initial response time for which</p> <ul style="list-style-type: none"> <li>a) Outage at Network Operation cum Monitoring Centre <ul style="list-style-type: none"> <li>i. Complete outage of communication connectivity</li> <li>ii. Failure of UPS system</li> <li>iii. Failure of Battery / other auxiliary system)</li> </ul> </li> <li>b) Partial outage of AMI functions <ul style="list-style-type: none"> <li>i. Outage of VEE</li> <li>ii. Billing Determinants</li> <li>iii. Reports etc.</li> </ul> </li> <li>c) Any single event on data privacy breach is not resolved</li> </ul>

Category	Example of computing non-available hours
	<ul style="list-style-type: none"> <li>d) Interruption of data exchange with <b>MVVNL</b> enterprise systems remains unresolved</li> <li>e) Adherence to RPO / RTO is not ensured</li> </ul>
Severity 3 – Minor	<p>Number of days beyond 10 days for which (Number of days shall be converted to number of hours by multiplying it with 24)</p> <ul style="list-style-type: none"> <li>a) Non-availability of reports as per Clause 6.2 of this Section during the Operation Phase</li> <li>b) Resolution of complaint ticket raised and passed on by CCS [These complaints shall be registered within the SLA Application and hence shall have to undergo mutual agreement checks between <b>MVVNL</b>/AMISP before being registered for resolution]</li> <li>c) Non-availability of required inventory of spares specified in Clause 7.3.3 of this Section</li> <li>d) Failure of workstation, printers, LAN etc. at the NOMC</li> <li>e) Non-availability of designated AMISP's Manpower at the NOMC</li> </ul>

**Annexure K****Schedule of billing data collection for different consumer category**

The schedule for billing for various consumers on which the current AMI system (procured under this contract) is implemented is provided below:

**K.1 Industrial Consumers**

<MVVNL to add details on schedule for the billing the industrial consumers for which the AMI system is implemented>

**K.2 Commercial consumers**

<MVVNL to add details on schedule for the billing the commercial consumers for which the AMI system is implemented>

**K.3 Residential consumers**

<MVVNL to add details on schedule for the billing the residential consumers for which the AMI system is implemented>

**K.4 Agricultural consumers**

<MVVNL to add details on schedule for the billing the agricultural consumers for which the AMI system is implemented>

<MVVNL to add /delete / modify the above sub-sections for other consumer categories for which the AMI system is implemented >

**Annexure L**

**Integration Interface of Existing Enterprise Applications**

<MVVNL to provide the required integration interface details of each of the existing enterprise applications which it wants to integrate with the AMI system>

---

**Annexure M**  
**Requirements/ Specifications**
**Additional**

<To be filled by the **MVVNL** and approved by REC / MoP>

**Single Phase Whole Current Smart Meter**

S. No.	Description of the Features
1	...
2	...

**Three Phase Whole Current Smart Meter**

S. No.	Description of the Features
1	...
2	...

**Three Phase LT-CT Operated Smart Meter**

S. No.	Description of the Features
1	...
2	...

**Three Phase CT/PT Operated Smart Meter**

S. No.	Description of the Features
1	...
2	...



## Annexure N

### Specifications of CT for LT-CT meters

#### Technical Specification of Current Transformer

##### 1. General:

This specification covers manufacture, test, & supply of LT Current transformers of class 0.5 accuracy. The CTs shall be suitable for metering purpose.

##### 2. Type:

The CTs shall be of ring type and bar type as per site requirement.

The secondary leads shall be terminated with Tinned Cooper rose contact terminals with arrangements for sealing purposes. Polarity (both for primary and second leads) shall be marked.

The CTs shall be varnished, fiberglass tape insulated or cast resin, air-cooled type. Only super enameled electrolytic grade copper wires shall be used.

The CTs shall conform to IS 2705:Part-I & II/IEC:185 with latest amendments.

#### 2.1. TECHNICAL DETAILS:

Technical details shall be as given below:

1.	Class of Accuracy	0.5
2.	Rated Burden	5.00 VA
3.	Power Frequency Withstand Voltage	3KV
4.	Highest System Voltage	433 V
5.	Nominal System Voltage	400 V
6.	Frequency	50 Hz
7.	Supply System	3 Ph. Solidly grounded Neutral System

Transformation ratio shall be specified from the following standard ratings as per requirement:

S,No	LTCT Consumers/DT rating	CT Ratio
1	>10 kVA upto 30kVA	50/5
2	>30kVA upto 47kVA	75/5
3	>47kVA upto 63 kVA	100/5
4	>63 kVA upto 94 kVA	150/5
5	>94kVA upto 125kVA	200/5
6	>125kVA upto 187kVA	300/5

7	>187kVA upto 250kVA	400/5
8	>250kVA upto 310kVA	500/5
9	>310kVA upto 375kVA	600/5
10	>375kVA upto 575kVA	800/5
11	>575kVA upto 700kVA	1000/5

Bore diameter of the CT shall not be less than 40 mm. Ring type CTs shall have suitable clamp to fix the CT to panel Board, wherever required.

The limits of current error and phase angle displacement as per IS:2705 at several defined percentage of rated current are:

Accuracy Class	% Ratio error at % of rated current				Phase displacement in minutes at % of rated current			
	0.5	5	20	100	120	5	20	100
1.5		0.75	0.5	0.5	90	45	30	30

Current error and phase displacement at rated frequency is required to be as above when the secondary burden from 25% to 100% of the rated burden i.e. 50 V A.

Rated extended primary current shall be 120% of rated primary Current in accordance with IS:2705 Pt-II.

Rated ISF (Instrument Security Factor) shall be declared by the manufacturer & marked on the CT.

CT's shall be made with good engineering practices. Core winding shall evenly spread stress & avoid stress concentration at any one point. Cast resin CT's shall be processed by hot curing method under controlled vacuum conditions.

The base shall be of hot dip galvanized steel.

## 2.2. TESTS

### 2.2.1. TYPE TESTS:

Copies of all type tests as per IS.2705 Part-I and II including short time current & temperature rise tests in NABL accredited laboratory shall be submitted and got approved before commencement of supply.

### 2.2.2. ROUTINE TESTS:

The supplier shall conduct all the routine tests such as Ratio test, phase angle error test for 0.5 accuracy class as per IS 2705 Part I & II.

### 2.2.3. COMMISSIONING TEST:

---

In accordance with IS:2705, Power frequency test on primary winding shall be carried out after erection on site on sample basis.

### **2.3. MARKING:**

The CTs shall have marking and nameplate as per IS 2705 in addition to class of insulation & ISF. The markings shall be indelible. The nameplate shall be securely fixed to the body of the CT.

### **2.4. PACKING:**

Each CT shall be securely packed to withstand rough handling during transit and storage.

### **2.5. QUALITY ASSURANCE PLAN:**

Immediately on award of contract, the bidder shall prepare detailed quality assurance plan / test procedure identifying the various stages of manufacture, quality checks performed at each stage, raw material inspection and the Customer hold points. The document shall also furnish details of method of checking, inspection and acceptance standards / values and get the approval of Purchaser before proceeding with manufacturing. However, Purchaser shall have right to review the inspection reports, quality checks and results of suppliers in house inspection department which are not Customer hold points and the supplier shall comply with the remarks made by purchaser or his representative on such reviews with regards to further testing, rectification or rejection.

Purchaser reserve the right to send any material out of the supply to any recognized laboratory for testing and the cost of testing shall be borne by the Purchaser. In case the material is found not in order with the technical requirement / specification, the charges along with any other penalty which may be levied is to be borne by the bidder. To avoid any complaint the supplier is advised to send his representative to the stores to see that the material sent for testing is being sealed in the presence of bidder's representative.

## **Annexure O Specifications of 1-ph and 3-ph Polycarbonate Meter Box and 2:1 & 4:1 Meter Box for 1-ph Consumers**

### **SCOPE**

This specification covers the technical requirements of design, manufacture, testing at manufacturer's works, packing, forwarding, supply and unloading at store/site and performance of single phase meter box intended to contain one number single phase whole current energy meter complete with all accessories for trouble free and efficient operation.

### **APPLICABLE STANDARDS**

The equipment covered by this specification shall unless otherwise stated, be designed, manufactured and tested in accordance with the latest edition of the following Indian/international standards and shall conform to the regulations of the local statutory authorities.

<b>S. No.</b>	<b>Standard Name</b>	<b>Title</b>
i.	IS:14772-2000	General requirements for Meter boxes for accessories for household and similar fixed electrical installations- specifications.
ii.	IS:11731(Part-II)-1992	Methods of test for determination of Flammability of solid electrical insulating material when exposed to an igniting source.
iii.	IS:4249-1967	Specification for classification and method of test for non- ignitable and self-extinguishing properties of solid electrical insulating materials.
iv.	IS:5133(Part-II)-1969	Specification for boxes far the Meter box of electrical accessories.
v.	IS:2500(Part-I)-2000	Sampling procedure for inspection by attributes part-I sampling schemes indexed by acceptance quality limit (AQL) for lot-by-lot inspection.
vi.	UL 746-C	Polymeric Materials in Electrical equipment.

### **GENERAL TECHNICAL REQUIREMENTS PROPERTIES OF PLASTIC MATERIAL**

The plastic material, which is to be used by the bidder for these molded Meter Box, must have the following properties:

<b>S. No</b>	<b>Property</b>	<b>Units</b>	<b>Value</b>
1.	Physical Water Absorption	%	Max. 0.35
2.	Thermal HDT	Deg. C	Min. 125.
3.	Flammability a) Rating b) Glow wire test @ 650 Deg. C		FV2 Passes

4.	Mechanical a) Tensile Strength b) Flexural strength c) Modulus of Elasticity d) Izod impact strength notched 23°C.	Mpa Mpa Mpa KJ/Sq.m.	Min. 50 Min. 90 Min. 2000 Min 8
----	--	-------------------------------	--

### Technical Requirements

S. No.	Description	Requirement
i.	Application	Outdoor
ii.	Degree of protection	IP 55
iii.	Flammability requirement	FV2
iv.	Grade of material	Polycarbonate with fire retardant, Self- Extinguishing, UV stabilized and anti-oxidation properties having good dielectric and mechanical strength.
v.	Material  a) Base:  b) Cover:	Meter box (base and Cover) shall be made of polycarbonate material which complies following properties; <ul style="list-style-type: none"> <li>• Meter box shall be weather proof</li> <li>• Capable to withstanding temperatures of boiling water for 5 minutes continuously without distortion or softening.</li> <li>• It shall withstanding Glow-wire test at 650DC as per IS:14772.</li> </ul> Polycarbonate with fire retardant, Self- Extinguishing, UV stabilized and anti-oxidation properties having good dielectric and mechanical strength. Opaque.  Polycarbonate with fire retardant, Self- Extinguishing, UV stabilized and anti-oxidation properties having good dielectric and mechanical strength. Transparent.
vi.	Material of the gasket	Rubber gasket
vii	Material withstand	125°C ± 2 °C

### GENERAL CONSTRUCTIONS:

- i. The meter box shall be weatherproof, tamper proof and shall be made of Injection moulded polycarbonate material with self-extinguishing, UV stabilized, recyclable and Anti oxidation properties having good dielectric and mechanical strength. The box shall be of adequate strength, unbreakable and shall be made in two pieces (base and cover). The base shall be opaque whereas the cover shall be completely transparent.
- ii. The meter Box shall have roof tapering down to both the sides for easy flow of rainwater and shall have IP 55 degree of protection for affording protection against dust and water.

iii. The thickness of the box shall not be less than 3.0 mm on the load bearing side and other sides, door and roof shall not be less than 2.5 mm.

iv. The box shall be designed in such a way that there should be the following clearances between the meter and the Meter box:

S. No.	Parameter	Minimum Clearance
i.	Between Sides of the meter body and meter box (Excluding the flanges on the meter body for sealing screws.)	30 mm
ii.	Between the lower edge of the terminal block and the box	70 mm
iii.	Between the back of the meter and the meter box base	10 mm
iv.	Between the front of the meter and the meter box front	10 mm
v.	Between the top of the meter and the meter box cover	20 mm

v. The meter base supports inside the box should have adequate strong enough moulded supports within the block to avoid damage during tightening of screws and raised by about 10 mm in the box for ease of wiring. While fixing, the meter screws should not protrude outside.

vi. The design of the meter box shall be such that it may facilitate easy wiring and access to the meter terminals. Suitable circular holes shall be provided at the bottom of the cupboard for inlet & outlet cables with glands of size 15/16mm suitable for 2 core armored aluminum cable(s) and for three phase meter, for internal gland diameter shall be 22-26 mm made of engineering plastic for the cable securely fixed to the bottom of the meter box on both sides by chuck-nuts. A suitable arrangement like clamping nut may be provided with the gland so that opening diameter can be reduced to the size of cable.

vii. The box cover shall be fixed to the base through two number hinges (approx. length 30 - 60 mm). The arrangement for hinges shall be provided on the side of the base and shall be such that it may avoid unauthorized access to inside of the box. Hinges should be outside and enclosed by polycarbonate material and once the box is closed and sealed, hinges should not be approachable. Box cover shall be openable by more than 90 degrees.

viii. For holding and sealing the box, two U-shaped latches shall be provided. The latch shall be GI sheet with minimum thickness 2 mm, to secure it with the base of the box. The latch shall be provided along with suitable clamp assembly in base as well as cover, such that these are fully covered by the latch after closing. The clamp along with the latch shall have a sealing hole such as to provide a through sealing arrangement in the assembly.

ix. For fixing the box to flat wall or wooden board 4Nos. holes (2Nos. key holes at top) of minimum 6 mm dia. shall be provided at the four corners of the meter box. For fixing of Box on flat wall, 4 Nos. 5mm diameter 40mm long, pan head self- tapping screws and washers shall be provided by the supplier with every Box. 4 Nos. plastic fixing plugs of 50mm length suitable for self-tapping screws shall also be provided.

x. The meter is to be installed in the Meter Box and the Meter Box in assembled condition shall have provision to fix it to a pole or on wall.

xi. A provision in form of depression should be provided on the meter box cover to download the meter data from the meter using the CMRI probe without opening the meter box cover. This shall be provided in such a way that the optical probe of the CMRI cable can be placed on top of the meter box cover in a suitable depression in the meter box cover, which is aligned suitably with the meter optical port. The meter box cover

shall have provision of sealing this depression. The depression so provided should be covered so that there is no physical access to the meter optical port while using this depression.

- xii. Suitable rubber gasket of round shape all around the cover along its periphery shall be provided for protection.
- xiii. After closing and sealing the meter box, it should not be possible to allow entry of any sharp object even forcefully inside the box without breaking base/cover.
- xiv. Suitable overlapping (approx. 10 mm) shall be provided between base and cover to avoid access to the meter or its accessories inside the meter box by any means after sealing the box.
- xv. The tolerance permissible in overall dimension of Meter Box shall be  $\pm 2\%$ .

**Meter Body Material:** Base body and top cover shall be made of UV stabilized, unbreakable high grade flame retardant insulating material of good dielectric and mechanical strength with FV2/V2 in-flammability level.

**Terminal Block:**

- a) The terminal block shall be moulded type made of non-hygroscopic, flame-retardant material having good dielectric and mechanical strength.
- b) The moulded terminal block shall be made from best quality phenol formaldehyde/Poly carbonate conforming to IS:13779-1999 (latest amended) having adequate insulating properties and mechanical strength with brass inserts for connecting terminals.
- c) The terminal block should satisfy all the conditions specified in IS:13779 and IEC 62052-11. The material of the terminal block should fulfil the requirement of following tests:
  - The flame retardant rating of V0 as per UL 94 testing.
  - The glow wire test for temperature of 960OC. as per IS:11000 (Part 2/Sec.1) or IEC 60695-2-1.
  - Heat deflection temperature (HDT) test of 135OC. as per ISO 75 or ASTM D-648
  - Ball pressure test at 125OC. as per IEC 60335-1.

**2:1 & 4:1 Meter Box arrangement for 1-ph Consumers:**

The bidder shall provide the design specification for the arrangement of 1:1 Meter box for 1-ph Consumers in Polycarbonate meeting the quality requirements as mentioned in the specification for Polycarbonate boxes.

---

**Annexure P Specifications of LTCT Meter Box****Scope:**

- This specification covers the design, manufacture, testing and supply of anti-corrosive, dust proof, rust proof, shock proof, vermin and water proof, U.V. stabilized and pilfer resistant meter boxes made of Glass reinforced, polyester sheet moulding compound (SMC) conforming to IS:13410:1992 (with latest amendment thereof) for installation on distribution transformers of various ratings.
- Meter boxes shall consist of two separate chambers, one suitable to accommodate LT TVM and other suitable for installation of 4 nos. single core, single ratio, ring type Current Transformers (CTs) of current ratios as per requirement in the RfP.

**Constructional Features of Meter Box:**

- LTCT SMC Box: Meter Box shall be made of minimum 2.5 mm. thick Glass reinforced Polyester sheet moulding compound (SMC) conforming to IS:13410:1992 with latest amendments thereof.
- LT meter box shall contain two separate chambers. The upper chamber shall be suitable to house 3 phase 4 wire energy meter. The lower chamber of the box is intended for housing 04 nos. ring type LT CTs. Both the chambers of box shall be independent from each other.
- The appropriate size of cables from the secondary of distribution transformer shall pass through ring type LT CTs.
- If any portion of box is closed, it shall not be possible to approach it by opening the other portion and vice-versa. It shall be moulded in a single piece forming the body of the Meter Box and CT chamber with SMC lid/shed fitted with the base by two nos. concealed brass hinges.
- The concealed brass hinges shall be fitted with the meter Box body base and the cover rigidly in such a way that the same are neither visible nor accessible from outside, thereby making the Meter Box pilfer proof.
- The door/cover in closed position should house properly within collar of meter box/ body base, which shall also house the edges of the lid/cover so that no direct entry or access is possible. • The box should have a front door opening with a window provided with toughened glass of minimum 4.0 mm. thickness for viewing and taking meter reading.
- The meter box shall be of moulded type without any fabrication joint made by the process of hot press compression moulding.
- The body of the Meter Box shall have such construction that while installing on the grouted bolts of base-wall/ mounting bracket, the top surfaces of the box shall have little tapering shape frame centre towards both sides of the meter box so that easy flow of rainwater etc. is facilitated.
- The meter box should be anti-corrosive, rust-proof, dust-proof, vermin-proof, water-proof, UN, stabilized and pilfer resistant. The meter box becomes completely closed by providing locking arrangement in the shape of two nos. clamps.
- Clamp shall have separate holes of 1 mm. dia. each across the meter box body base as well as covers for both the chambers separately



- 
- The meter box shall have four wall mounting bracket with proper screws to fix with the bottom base and provision for Four nos. holes each of 6 mm. dia.
  - The meter box should neither melt nor become soft or distort when tested up to temperatures 2500C. ( As per IS 13360 part 6 sec 10 1992 by 'A' capillary tube method The thickness of these boxes shall not be less than 2.5 mm on all sides including floor. The box shall have 3 mm thickness on the tongue and groove area. The meter box cover shall have a groove to hold minimum of 2.5 mm Neoprene gasket.
  - The tongue of the base shall ensure tongue, Groove and sealing arrangement against rainwater and dust entering inside the box. The box shall have its roof tapering down to both sides for easy flow of water.
  - The boxes shall generally comply with the provision of IS: 14772:2000. The boxes shall be suitable for outdoor / indoor application. The box shall be with good workmanship. There should be a minimum of 25 mm clearance on all sides and 25 mm clearance on the front and 10 mm clearance on the back of the meter.
  - Sufficient space should be available inside the meter box for making out-going connections of the leads with the terminal block of the meter.

***Material Of Meter Box:***

- LTCT SMC Box: Material for construction of meter box shall be glass reinforced polyester sheet moulding compound (SMC) as per IS: 13410:1992 Grade S-1 with latest amendment thereof. Thickness of boxes shall be 2.5 mm from all sides. However, thickness of partition plate shall be 2.0 mm.
- LTCT Polycarbonate boxes: The meter box shall be weather proof, tamper proof and shall be made of Injection moulded reinforce polycarbonate material with FV0 fire retardant, self-extinguishing, UV stabilization and Anti oxidation properties. The box shall be of adequate strength , unbreakable and shall be made in two pieces(base and cover). The base shall be dark grey color whereas the cover shall be completely transparent for polycarbonate material .The material for base and cover shall be polycarbonate with minimum cover thickens of 2.5mm & base -3 mm thickness.
- The material of meter box should be anti-corrosive, rust proof, waterproof, shock proof and U.V stabilized.
- Material of meter box should not get soften on heating. (Heat distortion temperature should be above 1702 C.)
- The material of Meter box should be self-extinguishing as per IS: 4249 with latest amendment thereof.
- All MS parts of the meter boxes shall be anti-corrosive treated.

***Rating Plate:*** Manufacturers should Screen Print the following information on each meter box.

- Name of Manufacturer
- Year of manufacturing
- Type of Meter
- PO NO with Date

- 
- Meter Box Number
  - Property of Utility

The same shall be finalized during GTP approval stage.

## Annexure Q Specifications of Service Cables

### SCOPE

This section provides for manufacture, testing before dispatch, supply and delivery F.O.R. destination of Four Core & Twin Core size 16mm<sup>2</sup>, 10mm<sup>2</sup> XLPE insulated and XLPE Sheathed Un-armored circular LT cables with aluminum conductor suitable for working voltage up to & including 1100 Volts ISI Marked & Conforming to IS 7098 (Pt-I)/1988 with latest amendments.

### STANDARDS

Unless otherwise stipulated in this specification the following standards with latest amendments shall be applicable.

- |                        |  |
|------------------------|--|
| a) IS: 7098(Pt-I)/1988 | XLPE Insulated (Heavy Duty) Electric cable for Voltages up to and including 1100 Volts working |
| b) IS: 8130/1984       | Conductors for insulated cables.   |
| c) IS: 5831/1984       | XLPE insulation and sheath of electric cables.   |
| d) IS: 10810/1984      | Method of test for cables.   |
| e) IS: 3975/1979       | Galvanized Steel Wire/Strips.  |
| f) IS: 10418/1982      | Drums for electric cables.   |

### CLIMATIC CONDITIONS:

<i>Parameters</i>	<i>Conditions</i>
Maximum altitude above sea level	5000m
Maximum ambient air temperature	50° C
Maximum daily average ambient air temperature	40° C
Minimum ambient air temperature	-30° C
Maximum temperature attainable by an object exposed to the sun	60 ° C
Maximum yearly weighted average ambient Temperature	32° C
Maximum relative humidity	100%
Average number of thunderstorm days per annum (isokeraunic level)	70
Average number of rainy days per annum	120
Average annual rainfall	1500 mm
Maximum wind pressure	260Kg/m <sup>2</sup>

Note: The atmosphere is generally laden with mild acid and dust in suspension during the dry months and is subjected to fog and snow in cold months. The design of equipment and accessories shall be suitable to withstand seismic forces corresponding to an acceleration of 0.3 g.

### GENERAL REQUIRMENT:

- a) The ISI marked XLPE Insulated Un-un-armored cables shall conform to IS: 7098(Pt-I) /1988 with latest amendment and bear BIS certification mark. The material used for construction of the cables shall

be of best quality complying with the requirement of IS: 7098(Pt-I)/1988 and other relevant standards. The cables shall be suitable for outdoor/indoor installation free in air and shall be capable of withstanding the normal stresses associated with transportation, erection, reeling and unreeling operations without getting deformed.

- b) The cable shall be suitable for use where combination of ambient temperature and temperature rise due to load results in a conductor temperature not exceeding 90 degree C under normal operation and 250 degree C under short circuit condition.
- c) The XLPE Insulated Un-Un-armored LT Cable shall be ISI marked. The (MANUFACTURER) must furnish valid ISI certificate along with offer.

**MATERIAL:**

**1) CONDUCTOR:**

The conductor shall be composed of aluminum wire complying with IS: 8130/1984 with latest amendments.

**2) INSULATION**

Insulation shall be cross linked Polyethylene (XLPE) conforming to the requirements Table-I of IS: 7098/1984 with latest amendments.

**3) FILLERS**

- The central hole/void, if any, of the cable shall be invariably filled with suitable filler material so that there is no gap in the center.
- The filler shall be of vulcanized rubber, un-vulcanized rubber or Thermoplastic material and shall be provided to fill the gaps between cores.
- The filler material shall be so chosen so as to be compatible with temperature of the cable and shall have no deleterious effect on other components of the cable. These shall not be harder than XLPE and PVC used for insulation and outer sheath respectively.

**4) OUTER SHEATH**

The outer sheath shall consist of type ST-2 PVC Compound conforming to the requirements of IS: 5831/1984.

**CONSTRUCTION:**

**1) CONDUCTOR**

The construction of the conductor shall be stranded for cable size 10 Sq. mm and above, as per Clause No. 8.1 of IS:7098(Pt-I)/1988 & relevant clause of IS:8130/1984.

A protective barrier may be applied between the conductor and insulation. Such barriers when used shall be compatible with insulating material and suitable for the operating temperature of the cable.

**2) INSULATION:**

The conductor (with protective barrier, wherever applied) shall be provided with Cross-Linked Polyethylene (XLPE) insulation applied by extrusion. The insulation shall be so applied that it fits closely on the conductor and it shall be possible to remove it without damage to the conductor. The thickness and tolerance on thickness of insulation shall be as per clause No. 9.2 of IS: 7098 (Pt- I)/1988.

**3) CORE IDENTIFICATION:**

The core shall be identified by different coloring of XLPE insulation as per Clause No. 10.1 of IS: 7098 (Pt-I)/1988.

**4) LAYING UP OF CORES :**

The cores shall be laid up together with the suitable right hand lay. The interstices shall be filled with non-hygroscopic material.

**5) INNER SHEATH (COMMON COVERING):**

- i. The laid up cores shall be provided with an inner sheath applied either by extrusion or by wrapping. It shall be ensured that it is as circular as possible. The thickness of inner sheath shall be as given in Table-5 of IS: 7098(Pt-I)/1988.
- ii. The inner sheath shall be so applied that it fits closely on the laid up cores and it shall be possible to remove it without damage to the insulation.

**6) OUTER SHEATH**

- i. The outer sheath shall be applied over the armoring.
- ii. The color of the outer sheath shall be black.
- iii. The minimum thickness of XLPE outer sheath shall not fall below the thickness specified in Table -8 of IS: 7098 (Pt-I) /1988.

**TESTS AND TEST CERTIFICATES:**

The cable should meet the requirement of all tests including optional tests as specified at Clause No. 15.4 of IS: 7098 (Pt. I) /1988.

The following shall constitute routine tests:

- a) Conductor resistance test.
- b) High Voltage test.

The following shall constitute Acceptance Tests:

- a) Tensile test (for Aluminum).
- b) Wrapping test (for Aluminum).
- c) Conductor resistance test.
  - i. Test for thickness of Insulation & Sheath.
  - ii. Tensile strength & elongation at break of Insulation & sheath.
  - iii. Insulation resistance (Volume Resistivity) test.
  - iv. High Voltage test.
  - v. Hot Set Test for Insulation.
  - vi. Cold Bend Test for outer sheath.
  - vii. Cold Impact Test for outer sheath.

The following shall constitute Type Tests

**I). Tests of Conductor**

- a. Tensile test (for aluminum)
- b. Wrapping test (for aluminum)
- c. Conductor resistance test.
- d. Test for Armoring Wires/ Strips

- 
- e. Test for thickness of insulation and sheath

II). Physical tests for insulation: Tensile strength and elongation at

- a. Ageing in air oven.
- b. Hot Set test.
- c. Shrinkage Test.
- d. Water Absorption (Gravimetric).

III). Physical tests for Outer Sheath:

- a. Tensile strength and elongation at break.
- b. Ageing in air oven.
- c. Loss of mass in air oven.
- d. Shrinkage Test.
- e. Hot Deformation Test.
- f. Heat shock Test.
- g. Thermal Stability.

IV). Insulation resistance (Volume Resistivity Test)

V). High voltage test.

VI). Flammability test.

**INSPECTION:**

- 1) The inspection may be carried out by the purchaser at any stage of manufacture. Free access should be granted to the purchaser's representatives at a reasonable time when the work is in progress. Inspection and acceptance of any equipment / material under this specification by the purchaser shall not relieve the supplier of his obligation of furnishing equipment in accordance with the specification and shall not prevent subsequent rejection if the equipment/material is found to be defective.
- 2) The supplier shall keep the purchaser informed in advance about the manufacturing program so that arrangement can be made for inspection.
- 3) The acceptance tests as per IS: 7098(Pt-I)/1988 shall also be conducted by the manufacturer before dispatch in the presence of purchaser's Representative / Inspecting Officer as per relevant clause of "General Conditions of Contract" along with verification of lengths & weight and checking the manufacturing defects, if any of samples coils. The mass of aluminum, XLPE, PVC & Filler in sample coils shall also be verified by the Inspecting Officer(s). Cold bend/ cold impact test (IS: 5831/1984) shall constitute the optional tests and shall be conducted on each offered lot of the cables of each size as per Clause No. 15.4 of IS: 7098(Pt-I)/1988.
- 4) TYPE TESTS:
  - a. The first lot offered shall not be less than 10% of ordered quantity of each size of LT XLPE UN-ARMORED & ARMOURED CABLE.
  - b. One sample from the 1<sup>st</sup> Lot of LT XLPE UN-ARMORED/ARMOURED Cable of each size as received in purchaser's store shall be selected and sealed by the inspecting officer nominated by purchaser's for getting it type tested at any NABL accredited testing laboratory. The charges incurred towards type test of the material received in our stores shall be borne by Supplier.

- 
- c. In case sample from first lot fails then:
- i. Supplier shall have to replace the full quantity of the respective inspected lot supplied to various stores and lying unused at stores.
  - ii. For the quantity already utilized against the order in field a deduction @ 15% (Fifteen Percent) of F.O.R. Destination prices of the material supplied shall be made.
  - iii. Sample from next lot shall be selected again for type test. All test charges incurred towards type test of the material for second time shall be borne by the Supplier. In case sample again fails in the type test then further supplies shall not be accepted.
- 5) The purchaser reserves the right to insist for witnessing the acceptance /routine tests of the bought out items.
- 6) At least 5% of total numbers of drums subject to minimum of 2 in each lot put up for inspection shall be selected at random to ascertain the length/workmanship of cable by the following method:
- a. At the work of the manufacture, the cable shall be transferred from one drum to another for checking any manufacturing defects in the cable drum selected for conducting acceptance tests, at the same time measuring its length with the help of pulley & cyclometer graduated in presence of inspector. The difference in the measured length thus obtained from the declared length by the supplier in the packing list shall be applied to all the drums if the cable is found short during checking the sample lot (s).
- 7) The supplier shall present the latest Calibration Certificate(s) of testing instruments/equipment to be used for the testing of the material covered in the Purchase Order to the authorized inspecting officer /inspecting agency of the purchaser. The testing instruments / meters /apparatus etc. should be got calibrated by the supplier from time to time from an independent testing laboratory / house having valid accreditation from National Accreditation Board for testing and calibrating laboratories for the testing equipment or from original manufacturers having trace ability to NABL /NPL. The calibration certificate(s) should not in any case be older than one year at the time of presenting the same to the inspecting officer / inspecting agency of the purchaser. The testing instruments / equipment should be duly sealed by the Calibrating Agency and mention thereof shall be indicated in the calibration certificate(s).
- 8) TEST CHECKING OF MATERIAL AT STORES:
- a. SAMPLING: One number out of each lot / sub-lot of 25 Nos. drums or part thereof for cables of size 10 Sq. mm. and above.
  - b. TESTS: The following tests shall be carried out:
    - i. Measurement of Resistance of conductor.
    - ii. Tensile & Elongation test for insulation.
    - iii. Thickness of Insulation.
  - c. CRITERIA FOR ACCEPTANCE:
    - i. If the measured conductor resistance of the sample(s) exceeds beyond 2% as per the resistance specified in the contract, the material shall be rejected and the same shall have to be replaced by the supplier.
    - ii. If the measured conductor resistance of the sample(s) exceeds the value specified in the contract but does not exceed by more than 2% of the resistance value specified in the contract, the material pertaining to the relevant lot/ sub-lot to shall be accepted with a deduction @ 1.5% of the cost of cable for increase in resistance for every 1% or part thereof.
    - iii. If the sample(s) fails in any other test, the material contained in the pertinent lot/sub-lot shall be rejected and shall have to be replaced by the supplier.
  - d. TEST CHARGES: All test charges incurred towards test checking of the material received in our stores shall be borne by the PURCHASER.
- 9) The manufacturer shall be responsible to pay penalty of Rs 20,000/- for each occasion at which the fake inspection call has been made or the material is rejected during testing/inspection by the authorized agency/representative of the Purchaser. This penalty would be in addition to the expenses incurred by

---

the Purchaser in deputing the Inspecting Officer, carrying out such inspection.

**IDENTIFICATION:**

- 1) The manufacture shall be identified through-out the length of cables as per Clause No. 17.1 of IS: 7098(Pt-1)/1988.
- 2) In order to distinguish these electric cables from telephone cables, the word ELECTRIC shall be indicated, printed or embossed throughout the length of the cable on outer sheath.
- 3) The cable code shall be provided as per Clause No. 17.3 of IS: 7098 (Pt- I)/1988.
- 4) The cable shall also be required to be embossed with the word Name of Manufacture or trade name, Cable code, Voltage Grade, **MVVNL** name, size of cable, year of manufacture and ISI certification mark at every meter length for which no extra charges shall be paid.
- 5) The cable shall be colour coded as per requirement of the **MVVNL**.

**PACKING AND MARKING:**

- 1) The cables shall be wound on non-returnable wooden drums conforming to IS: 10418/1982 of suitable size and packed. The ends of the cable shall be sealed by means of non-hygroscopic sealing material. Only one cable length shall be supplied on a drum.
- 2) The cable shall carry the following information stenciled /painted on the drum:
  - a. Manufacturer's name, Brand name or trade mark.
  - b. Type of cable and voltage grade.
  - c. Number of Cores.
  - d. Nominal Cross-sectional area of the conductor.
  - e. Cable Code.
  - f. Length of cable on the drum.
  - g. Approximate gross weight.
  - h. Year of manufacture.
  - i. BIS Certification marks.
  - j. Name of the Consignee and full destination.
  - k. Tender number/Purchase Order No.
  - l. The word SUITABLE FOR OUTDOOR USE & LOW TEMPERATURE CONDITIONS.

**STANDARD LENGTH:**

- 1) The cables shall be supplied in the standard length of 500 Meter for, 4CX16 Sq. mm<sup>2</sup>, and 1000 Meter for size 4CX10Sq. mm<sup>2</sup>, 2CX16Sq. mm<sup>2</sup> 2CX10 Sq. mm<sup>2</sup>.
- 2) A tolerance (+/-) 5 % shall be allowed in standard length.
- 3) Only one cable length shall be acceptable by non-standard length measuring not less than 50% of standard length to complete the ordered quantity in each size.

**GUARANTEED TECHNICAL PARTICULARS:**

The **MVVNL** shall furnish guaranteed technical particulars in the relevant schedule **[To be inserted by the MVVNL as Annexure]**.

**CHALLENGE CLAUSE:**

The material offered/received after the inspection by the authorized inspecting officer may again be subjected to the test for or any parameter from any testing house/in-house technique of the Purchaser & the results if found deviating un-acceptable or not complying to approved GTPs the bidder shall arrange to supply the replacement within thirty (30) days of such detection at his cost including to & fro transportation. In addition, penalty @10% of cost of the inspected lot of material shall be imposed.

**WARRANTY PERIOD:**



---

The supplier shall be responsible to replace, free of cost, with no transportation or insurance cost to the purchaser, up to destination, the whole or any part to the material which in normal and proper use proves the defective in quality or workmanship, subject to the condition that the defect is noticed within 18 months from the date of receipt of material in stores or 12 months from the date of commissioning whichever period may expire earlier. The consignee or nay other officer of Purchaser actually using the material will give prompt notice of each such defect to the supplier. The replacement shall be effected by the supplier within a reasonable time, but not, in any case, exceeding 45 days/ The supplier shall, also, arrange to remove the defective within a reasonable period, but not exceeding 45 days from the date of issue of notice in respect thereof, failing which, the purchaser reserve the right to dispose of defective material in any manner considered fit by him (purchaser), at the sole risk and cost of the supplier. Any sale proceeds of the defective material after meeting the expenses incurred on its custody, disposal handling etc., shall however be credited to the supplier's account and set off against any outstanding dues of the purchaser against the supplier. The warranty for 12/18 months shall be one time.

---

**Annexure R—Specifications of DT Cables**
**SCOPE:**

The scope of this specification covers the design, manufacture inspection and testing the finished ISI marked LT (1100 volts, 35 Sq.mm to 630 Sq.mm stranded, compact aluminum conductor, with XLPE insulated, PVC inner sheathed, unarmoured and overall PVC sheathed Black colour cable conforming to IS:7098 /88 with latest amendments and as per specification detailed.

**RATED VOLTAGE:**

The rated voltage of the cable shall be 1100 Volts AC with the highest system voltage of 1100 Volts between phases of the effectively earthed three phase transmission system.

The cables shall be capable of operating continuously under the system frequency variation of  $\pm 3$  Hz, voltage variation of  $\pm 10\%$  and a combined frequency—voltage variation of  $\pm 10\%$ .

**APPLICABLE STANDARDS:**

- i) Unless otherwise stipulated in the specifications, the latest version of the following Standards shall be applicable:
- IS 7098 (Part 2) Cross linked Polyethylene insulation for Cables.
  - IS 8130 Conductors for insulated electrical cables and flexible cords.
  - IS 10810(series) Methods of tests for cables.
  - IS 10418 Drums for electric cables.
  - IS 3975 Specification for mild steel wires, strips and tapes for armouring of cables.
  - IS 5831 Specification for PVC insulation sheath for electric cables.
  - IS 10462 Fictitious calculation method for determination of dimensions of protective coverings of cables Part 1—Elastomeric and thermoplastic insulated cables.
- ii) The cables manufactured to any other International Standards like BSS, IEC or equivalent standards not less stringent than Indian Standards are also acceptable. In such cases the Manufacturer shall enclose a copy of the equivalent international standard, in English language.

**CONSTRUCTION:**

**Conductor:** The cable conductor shall be made from stranded aluminum to form compact sector shaped conductor having resistance within the limits specified in IS:8130/1984 and any amendment thereof. The wires shall be laid up together with a suitable right hand lay. Stranded Class 2 as per the IS:8 130 / IEC 60228/ BS 6360 standards.

**Insulation:**— The insulation shall be cross linked polyethylene applied by extrusion and shall be steam (wet) cured as per IS:7098(1)1988 and curing in hot water tank/bath is not accepted.:

<u>Sl.No.</u>	<u>Properties</u>	<u>Requirements</u>
1.	Tensile Strength	12.5N/mm <sup>2</sup> , Min.
2.	Elongation to break	200 percent, Min
3.	Aging in air oven: a) Treatment: Temperature: Duration: b) Tensile Strength variation: c) Elongation variation:	135±3°C 7 days ±25 percent, Max ±25 percent, Max
4.	Hot set: a) Treatment: Temperature: Time under load Mechanical stress b) Elongation under load c) Permanent elongation (set) after cooling	200±3°C 15 min 20N/cm <sup>2</sup> 175 percent, Max 15 percent, Max
5.	Shrinkage: a) Treatment: Temperature Duration b) Shrinkage	130±3°C 1 hour 4 percent, Max
6.	Water absorption (Gravimetric): a) Treatment: Temperature: Duration b) Water absorbed	85±2°C 14 days 1 mg/cm <sup>2</sup> , Max
7.	Volume Resistivity a) at 27°C b) at 70°C	1x10 <sup>14</sup> ohm-cm, Min 1x10 <sup>13</sup> ohm-cm, Min
8	Thermal Resistivity	350 degrees C cm/W
9	Power factor at maximum conductor Temperature	0.008
10	Dielectric strength	22 kV/mm

The XLPE insulation should be suitable for specified 1.1 KV system voltage.

The manufacturing process shall ensure that insulations shall be free from voids.

The insulation shall withstand mechanical and thermal stresses under steady state and transient operating conditions.

The insulation of the cable shall be high stranded quality, specified in IS:7098 (Part II/1985). Withstand continuous conductor temperature of 90 deg C, which means higher continuous rated current carrying capacity.

The cables can operate even at conductor temperature of 130 deg C continuously and 250 deg C during a Short Circuit condition.

#### ***SHEATH:***

The sheath shall be suitable to withstand the site conditions and the desired temperature. It should be of adequate thickness, consistent quality and free from all defects. The PVC sheath shall be extruded as per IS:7098 (Part I/1988). IEC:60502 Part I, BS:6622, LSOH to BS:7835.

The cable shall be without armouring shall also be accepted of type detailed in price schedule.

**OUTER SHEATH :** Extruded PVC ST2, outer sheath as per IS:5831/1984, IS:7098 Part 1, IEC:60502 Part 1, BS:6622, LSOH to BS:7835. shall be applied over armoring with suitable additives to prevent attack by rodents and termites. Outer sheathing shall be designed to offer high degree of mechanical protection and shall also be heat, oils, chemicals, abrasion and weather resistant. Common acids, alkalis, saline solutions etc., shall not have adverse effects on the PVC sheathing material used.

The cables should be suitable for use in solidly earthed system.

The power cables shall be manufactured to the highest quality, best workmanship with scientific material management and quality control. The Manufacturer shall furnish the quality plan, giving in detail the quality control procedure / management system.

The cable shall be suitable for laying in covered trenches and/or buried underground to meet the outdoor application purposes.

#### ***SYSTEM DETAILS:***

<b><u>General Technical particulars</u></b>	
Nominal system voltage (rms) (U)	0.44kV
Highest system voltage (rms) (U <sub>m</sub> )	1.1 kV
Number of Phase	3
Frequency	50Hz
Variation in Frequency	+/- 3%
Type of Earthing	Solidly Earthed
Total relay & circuit breaker Operating time	15—20 cycles

#### ***CLIMATIC CONDITIONS:***

(a)	Maximum ambient air temperature (in shade)	45 <sup>o</sup>	°C
(b)	Maximum ambient air temperature (under sun)	50 <sup>o</sup>	°C
(c)	Maximum daily average ambient air temperature	35 <sup>o</sup>	°C
(d)	Maximum yearly average ambient air temperature	30 <sup>o</sup>	°C
(e)	Minimum ambient air temperature	-30deg	°C
(f)	Maximum humidity	100%	
(g)	Altitude above M.S.L.	Up to 1000M	
(h)	Average No. of thunder storm days per annum	50	
(i)	Average No. of dust storm days per annum	Occasional	
(j)	Average No. of rainy days / annum	90	
(k)	Average Annual Rain fall	925mm	
(l)	Normal tropical monsoon period	4 months	
(m)	Maximum wind pressure	150 kg/Sq.M	

***MATERIALS:***

**Conductor:** The conductor shall be of stranded construction. The material for conductor shall consist of the plain aluminum of H2 or H4 grade as per clause — 3 of IS 8130/ 1984.

The minimum number of wires shall be 53 for circular compacted 400 sq. mm aluminum conductor as per table — 2 of IS 8130/ 1984.

***INSPECTION AND QUALITY CONTROL:***

The Manufacturer shall furnish a complete and detailed quality plan for the manufacturing process of the cable. All raw materials shall conform to relevant applicable standards and tested for compliance to quality and requirement. During the manufacturing process, at all stages, inspections shall be made to check the physical and dimensional parameters, for verification to compliance to the standards. The Manufacturer shall arrange, for inspection by the purchaser, during manufacture with one month advance notice for verifying the various stage inspections as specified in the quality assurance plan enclosed to verify the quality control process of the Manufacturer.

***TYPE TESTS:***

Type test certificates from Accredited NABL Testing Laboratories for 1.1 kV XLPE, shall be submitted along with Purchase order. The Type Tests should have been conducted not later than 5 years as on the date of supply.

1. ~~Stage wise Inspection: The Manufacturer shall offer the stage wise inspection as detailed in the in the quality assurance plan~~
2. ~~All acceptance tests shall be conducted in the presence of the Employer's representative.~~
3. ~~The supplier shall give 10 days advance notice for inspections, and witnessing of tests by the Employer representative.~~
4. ~~The following type tests shall be conducted on the cable.~~

***ACCEPTANCE TEST:***

The sampling plan for acceptance test shall be as per IS 7098 part II, Appendix 'A'. The following shall constitute the acceptance test.

- a. ~~Tensile test for aluminum.~~
- b. ~~Wrapping test for aluminum.~~
- c. ~~Conductor resistance test.~~
- d. ~~Test for thickness of insulation.~~
  - (i) ~~Test for thickness of inner and outer sheath.~~
  - (ii) ~~Hot set test for insulation.~~
  - (iii) ~~Tensile strength and elongation at break test for insulation and outer sheath.~~
  - (iv) ~~High voltage test.~~
  - (v) ~~Insulation resistance (volume resistivity) test.~~

***ROUTINE TEST:***

The following shall constitute routine tests:

- i. ~~Conductor resistance test.~~
- ii. ~~High voltage test.~~

***PACKING:***

The cables, as per specified delivery lengths, shall be securely wound /packed in non returnable wooden drums, capable of withstanding rough handling during transport by Rail, Road, etc. The packing should withstand storage conditions in open yards. The cable drums shall conform to IS 10418 1982 or equivalent standard. The dimensional drawings of wooden drums shall be furnished with the Purchase order. The drum shall be provided with circumferential lagging of strong wooden planks. The end of the cable shall be sealed with good quality heat shrink sealing caps. The sufficiently required additional sealing caps shall be supplied for use of testing during laying and jointing at site and to seal spare lengths of cable. The packing should be able to withstand the rigorous of transport. The following information in bold letters in English shall be painted on the flanges.

- a. ~~Name & Address of the manufacturer, Trade name/Trade mark/Brand~~
- b. ~~ISI Marking~~
- c. ~~Size of cable (Cross section) rated voltage, standard, insulation, cable code, drum No., and year of manufacture.~~
- d. ~~Length of cables (Meters)~~
- e. ~~Direction of rolling~~
  - i) ~~Net weight (in Kg)~~

- 
- ~~ii) Gross weight (in Kg)~~
  - ~~iii) Owners purchase order reference.~~

---

**Annexure S Price variation for Service Cables & DT Cables**

The price adjustment on the Ex-works price component, less advance, of Cables shall be as follows:

Terms used in price variation formula:

P = Price payable as adjusted in accordance with the appropriate formula (in Rs/km)

Po = Price quoted/confirmed (in Rs/km)

**Aluminium**

AIF = Variation factor in Aluminium (as published by IEEMA)

Al = Price of EC grade aluminium rods (Properzi rods) (as published by IEEMA). This price is as applicable on the first working day of the month, one month prior to the date of delivery.

Alo = Price of EC grade aluminium rods (Properzi rods) (as published by IEEMA). This price is as applicable on the first working day of the month, one month prior to the date of tendering.

**PVC Compound Polymer**

Cc = Price of PVC compound (as published by IEEMA). This price is as applicable on the first working day of the month, one month prior to the date of delivery.

Cco = Price of PVC compound (as published by IEEMA). This price is as applicable on the first working day of the month, one month prior to the date of tendering.

CCFAI = Variation factor for PVC Compound/ Polymer for aluminium conductor cable (as published by IEEMA)

CCFCu = Variation factor for PVC Compound/ Polymer for copper conductor cable (as published by IEEMA)

The prices and indices mentioned above are published by IEEMA vide circular reference

IEEMA(PVC)/Cable/--/-- prevailing as on 1<sup>st</sup> working day of the month i.e., one month prior to the date of tendering.

Price variation formulae for Power Cables

A. Aluminium conductor PVC insulated 1.1kV power cables

$P = P_o + AIF (AL - A_{lo}) + CCFAI (CC - C_{co}) + FeF (Fe - Fe_o)$

For unarmoured multicore cables (without steel armour); FeF = 0

D. Aluminium conductor XLPE insulated 1.1kV power cables

$P = P_o + AIF (AL - A_{lo}) + CCFAI (CC - C_{co}) + FeF (Fe - Fe_o)$

For unarmoured cables; FeF = 0

For steel armoured cables; AIF = 0

For aluminium armoured cables ; FeF = 0

For unarmoured cables ; FeF, AIF = 0

G. For Aluminium conductor XLPE insulated 3.3 to 33kV power cables

$P = P_o + AIF (Al - A_{lo}) + CCFAI (Cc - C_{co}) + FeF (Fe - Fe_o)$

For unarmoured multicore cables (without steel armour); FeF = 0

*Note : In case of any clarifications in the above formula kindly refer the IEEMA price variation formula given in circular IEEMA/PVC/CABLE/2007 effective from 1<sup>st</sup> January 2007, In case of any discrepancies the IEEMA circular mentioned shall prevail.*



### Annexure T: Specification of Polycarbonate Seals.

#### Specification of Poly Carbonate Seals required for Sealing of Single / Poly Phase Meters

1	<b>SCOPE</b>	<p>The specification covers the design, manufacture, testing at manufacturers works, supply and delivery at destination stores of tamper evident poly-carbonate security seals (Anchor type) heat resistant for sealing of Meter body and terminal covers of energy meters, Meter Box, CT-PT Units etc. with non-corrosive, non-magnetic stainless steel sealing wire.</p> <p>It is not the intent to specify completely herein all the details of technical design and construction of material. However, the material shall conform in all respects to high standards of engineering, design and workmanship and shall be capable of performing in continuous commercial operation in manner acceptable to the purchaser, who will interpret the meanings of drawings and specification and shall have the power to reject any work or material which, in his judgment is not in accordance therewith. The offered material shall be complete with all components necessary for their effective and trouble free operation. Such components shall be deemed to be within the scope of Bidder's supply irrespective of whether those are specifically brought out in this specification and/or the commercial order or not.</p>																											
2	<b>APPLICABLE STANDARDS</b>	<p>The equipment covered by this specification shall conform to the requirements stated in latest editions &amp; amendments of relevant Indian/ IEC Standards and shall conform to the regulations of local statutory authorities.</p> <table border="1" data-bbox="500 1142 1479 1850"> <tr> <td data-bbox="500 1142 581 1215">A</td> <td data-bbox="581 1142 846 1215">IS 9000</td> <td data-bbox="846 1142 1479 1215">Basic Environmental testing procedure for electrical and electronic items.</td> </tr> <tr> <td data-bbox="500 1215 581 1329">B</td> <td data-bbox="581 1215 846 1329">IS 15707 : 2006</td> <td data-bbox="846 1215 1479 1329">Testing, evaluation, installation and Maintenance of ac electricity meters — Code of practice</td> </tr> <tr> <td data-bbox="500 1329 581 1388">C</td> <td data-bbox="581 1329 846 1388">ASTM F 997</td> <td data-bbox="846 1329 1479 1388">Standard Specification for Polycarbonate Resin</td> </tr> <tr> <td data-bbox="500 1388 581 1465">D</td> <td data-bbox="581 1388 846 1465">ASTM D792-08</td> <td data-bbox="846 1388 1479 1465">Specific Gravity</td> </tr> <tr> <td data-bbox="500 1465 581 1524">E</td> <td data-bbox="581 1465 846 1524">ASTM G154</td> <td data-bbox="846 1465 1479 1524">Exposure to UV radiations</td> </tr> <tr> <td data-bbox="500 1524 581 1602">F</td> <td data-bbox="581 1524 846 1602">ASTM B 117 - 09</td> <td data-bbox="846 1524 1479 1602">Salt Spray Test</td> </tr> <tr> <td data-bbox="500 1602 581 1715">G</td> <td data-bbox="581 1602 846 1715">IS 15707 : 2006</td> <td data-bbox="846 1602 1479 1715">Testing Evaluation installation and maintenance of AC Electricity Meters- Code of practice.</td> </tr> <tr> <td data-bbox="500 1715 581 1774">H</td> <td data-bbox="581 1715 846 1774">IEC 60068</td> <td data-bbox="846 1715 1479 1774">Environmental testing.</td> </tr> <tr> <td data-bbox="500 1774 581 1850">I</td> <td data-bbox="581 1774 846 1850">CBIP-TR No.325</td> <td data-bbox="846 1774 1479 1850">Specification for A.C. Static Electrical Energy Meters (latest amendment)</td> </tr> </table>	A	IS 9000	Basic Environmental testing procedure for electrical and electronic items.	B	IS 15707 : 2006	Testing, evaluation, installation and Maintenance of ac electricity meters — Code of practice	C	ASTM F 997	Standard Specification for Polycarbonate Resin	D	ASTM D792-08	Specific Gravity	E	ASTM G154	Exposure to UV radiations	F	ASTM B 117 - 09	Salt Spray Test	G	IS 15707 : 2006	Testing Evaluation installation and maintenance of AC Electricity Meters- Code of practice.	H	IEC 60068	Environmental testing.	I	CBIP-TR No.325	Specification for A.C. Static Electrical Energy Meters (latest amendment)
A	IS 9000	Basic Environmental testing procedure for electrical and electronic items.																											
B	IS 15707 : 2006	Testing, evaluation, installation and Maintenance of ac electricity meters — Code of practice																											
C	ASTM F 997	Standard Specification for Polycarbonate Resin																											
D	ASTM D792-08	Specific Gravity																											
E	ASTM G154	Exposure to UV radiations																											
F	ASTM B 117 - 09	Salt Spray Test																											
G	IS 15707 : 2006	Testing Evaluation installation and maintenance of AC Electricity Meters- Code of practice.																											
H	IEC 60068	Environmental testing.																											
I	CBIP-TR No.325	Specification for A.C. Static Electrical Energy Meters (latest amendment)																											

		J	CEA Regulation : 2006	Installation and operation of meters Dtd: 17/03/2006 or latest amendment																																				
		K	Supply code	Delhi Supply Code 2006																																				
<b>3</b>	<b>CLIMATE CONDITIONS OF THE INSTALLATION</b>	<table border="1"> <thead> <tr> <th>Sl. No.</th> <th>Parameters</th> <th>Specified Values</th> </tr> </thead> <tbody> <tr> <td>1</td> <td>Maximum Ambient temperature</td> <td>50°C</td> </tr> <tr> <td>2</td> <td>Yearly average temperature</td> <td>32°C</td> </tr> <tr> <td>3</td> <td>Daily average temperature</td> <td>42°C</td> </tr> <tr> <td>4</td> <td>Minimum temperature</td> <td>-25°C</td> </tr> <tr> <td>5</td> <td>Height above sea level</td> <td>1500-2200 Mtrs.</td> </tr> <tr> <td>6</td> <td>Max. relative humidity</td> <td>100%</td> </tr> <tr> <td>7</td> <td>Min. relative humidity</td> <td>10%</td> </tr> <tr> <td>8</td> <td>Average No. of thunder storm days per year</td> <td>54 days</td> </tr> <tr> <td>9</td> <td>Average rainfall</td> <td>118 cm</td> </tr> <tr> <td>10</td> <td>Max. wind pressure</td> <td>130 kgs/m<sup>2</sup></td> </tr> <tr> <td>11</td> <td>Average number of rainy days per year</td> <td>106 days</td> </tr> </tbody> </table> <p>The atmosphere is generally laden with mild acid and dust in suspension during the dry months and is subjected to fog in cold months. The design of equipment and accessories shall be suitable to withstand seismic forces corresponding to an acceleration of 0.3 g.</p>			Sl. No.	Parameters	Specified Values	1	Maximum Ambient temperature	50°C	2	Yearly average temperature	32°C	3	Daily average temperature	42°C	4	Minimum temperature	-25°C	5	Height above sea level	1500-2200 Mtrs.	6	Max. relative humidity	100%	7	Min. relative humidity	10%	8	Average No. of thunder storm days per year	54 days	9	Average rainfall	118 cm	10	Max. wind pressure	130 kgs/m <sup>2</sup>	11	Average number of rainy days per year	106 days
Sl. No.	Parameters	Specified Values																																						
1	Maximum Ambient temperature	50°C																																						
2	Yearly average temperature	32°C																																						
3	Daily average temperature	42°C																																						
4	Minimum temperature	-25°C																																						
5	Height above sea level	1500-2200 Mtrs.																																						
6	Max. relative humidity	100%																																						
7	Min. relative humidity	10%																																						
8	Average No. of thunder storm days per year	54 days																																						
9	Average rainfall	118 cm																																						
10	Max. wind pressure	130 kgs/m <sup>2</sup>																																						
11	Average number of rainy days per year	106 days																																						
<b>4</b>	<b>GENERAL TECHNICAL REQUIREMENTS</b>	<table border="1"> <thead> <tr> <th>S. No</th> <th>DESCRIPTION</th> <th>REQUIREMENT</th> </tr> </thead> <tbody> <tr> <td>4.1</td> <td>Material of seal</td> <td>Polycarbonate grade 143R or equivalent</td> </tr> <tr> <td>4.2</td> <td>UV resistance properties</td> <td>Should not get affected by UV rays</td> </tr> <tr> <td>4.3</td> <td>Boiling water, acid or chemicals resistance</td> <td>Seal shall not be affected by boiling water, acid or chemicals</td> </tr> <tr> <td>4.4</td> <td>Seal wire</td> <td>Seal should have 6 inch long 26 gauges, twisted strand stainless steel wire non-corrosive &amp; non magnetic</td> </tr> <tr> <td>4.5</td> <td>Temperature Withstand</td> <td>147 deg. Cel.</td> </tr> <tr> <td>4.6</td> <td>THICKNESS OF SEAL</td> <td>Minimum 1mm thick</td> </tr> <tr> <td>4.7</td> <td>Serial number printing &amp; visibility</td> <td>Serial number should be laser printed on male &amp; female part &amp; should be separately visible after closing of seal</td> </tr> <tr> <td>4.8</td> <td>Company MONOGRAM</td> <td>MVVNL Monogram to be embossed as specified.</td> </tr> <tr> <td>4.9</td> <td>Embossing quality</td> <td>Embossing should have superior quality with good smooth finish.</td> </tr> <tr> <td>4.10</td> <td>Seal design</td> <td>Seal should be constructed/moulded</td> </tr> </tbody> </table>			S. No	DESCRIPTION	REQUIREMENT	4.1	Material of seal	Polycarbonate grade 143R or equivalent	4.2	UV resistance properties	Should not get affected by UV rays	4.3	Boiling water, acid or chemicals resistance	Seal shall not be affected by boiling water, acid or chemicals	4.4	Seal wire	Seal should have 6 inch long 26 gauges, twisted strand stainless steel wire non-corrosive & non magnetic	4.5	Temperature Withstand	147 deg. Cel.	4.6	THICKNESS OF SEAL	Minimum 1mm thick	4.7	Serial number printing & visibility	Serial number should be laser printed on male & female part & should be separately visible after closing of seal	4.8	Company MONOGRAM	MVVNL Monogram to be embossed as specified.	4.9	Embossing quality	Embossing should have superior quality with good smooth finish.	4.10	Seal design	Seal should be constructed/moulded			
S. No	DESCRIPTION	REQUIREMENT																																						
4.1	Material of seal	Polycarbonate grade 143R or equivalent																																						
4.2	UV resistance properties	Should not get affected by UV rays																																						
4.3	Boiling water, acid or chemicals resistance	Seal shall not be affected by boiling water, acid or chemicals																																						
4.4	Seal wire	Seal should have 6 inch long 26 gauges, twisted strand stainless steel wire non-corrosive & non magnetic																																						
4.5	Temperature Withstand	147 deg. Cel.																																						
4.6	THICKNESS OF SEAL	Minimum 1mm thick																																						
4.7	Serial number printing & visibility	Serial number should be laser printed on male & female part & should be separately visible after closing of seal																																						
4.8	Company MONOGRAM	MVVNL Monogram to be embossed as specified.																																						
4.9	Embossing quality	Embossing should have superior quality with good smooth finish.																																						
4.10	Seal design	Seal should be constructed/moulded																																						

				with one piece twisted sealed wire & polycarbonate male & female part such way that no extra seal wire is required.
		4.11	Surface finish	The surface should be free from any burr or casting voids etc.
		4.12	Colour shade	The colour shades of all seals of specific color should be same. The color code will be provided by <b>MVVNL</b> .
<b>5</b>	<b>GENERAL CONSTRUCTIONS</b>	<p>5.0.1 The seal shall be capable to withstand temperature upto 147 deg. C without any damage / deformation.</p> <p>5.0.2 The seal shall be designed for a single use only and if tampered with the help of plier, knife or any other sharp instruments, the seal shall be damaged and due to its transparent property, the sign of internal tampering shall be easily detected. Also once opened, it cannot be re-used.</p> <p>5.0.3 The seal shall be made in such a way that, it can be easily locked with the help of finger and thumb pressing no tools shall be required to close the seal in the laboratory or at site.</p> <p>5.0.4 Both the parts shall be designed in such a way that they cannot be separated and the attachment shall be flexible and shall not break. After inserting the seal wire through female part, the cap of the male part shall be fitted in the female part in such a way that it should not leave any space to avoid insertion of any sharp tools for opening of seal body of the female part in hot or cold condition.</p> <p>5.0.5 The seal shall have also the following features:-</p> <ol style="list-style-type: none"> <li>Tamper resistance and reliable.</li> <li>Environmentally safe as it does not contain any lead.</li> <li>Withstand long-term exposure to direct sunlight.</li> <li>Required no tools for installation.</li> <li>Transparent.</li> <li>Heat resistance.</li> </ol>		
<b>5.1</b>	<b>Design</b>	<p>5.1.1 The seal shall be anchor (Push Fit) type tamper evident with double locking.</p> <p>5.1.2 There shall not be any change in size, shape or design of the seal than the approved tender samples. If the seal is found different than the approved design / shape / size, the same shall be out rightly rejected.</p>		

		<p>5.1.3 The double anchor should not be so soft that it can be easily pressed before sealing, so that after pressing the seal cannot be opened.</p> <p>5.1.4 The double anchor should be very hard such that it should not require plier to press fit. Should be easily press fit with hand/ thumb pressure.</p> <p>5.1.5 The wall thickness of seal should be minimum one mm (1mm).</p> <p>5.1.6 Seal shall be made of unbreakable, high grade, fire retardant reinforced Insulating material with FV0 Fire Retardant, self - extinguishing, UV stabilize, recyclable and Anti oxidation properties.</p> <p>5.1.7 Non repeat seven digits Sr. No. With Code No. shall be laser etched / embossed during moulding (it shall not be screen printed) in contrast color on one side of capsule body (female).</p> <p>5.1.8 The Sr. No. shall also be laser etched / embossed during moulding (it shall not be screen printed) in contrast color on top of the male part.</p> <p>5.1.9 The laser etched printing shall be through complete thickness of the polycarbonate.</p> <p><b>5.1.10</b> Hole for inserting sealing wire of diameter of 1mm only with <math>\pm</math> 0.1mm tolerance.</p>
<b>5.2</b>	<b>Color of Seal</b>	<p>5.2.1 The female portion of the Polycarbonate Seal(s) shall be available in Clear color and should be transparent (see through) type, which shall give complete visualization of its fixing mechanism and shall show clear indication if tampered.</p> <p>5.2.2 Male part Anchor type body may be in colors of Red / Yellow/ Green/ Violet/ Orange or as per requirement of <b>MVVNL</b>. The color of seal should not fade with UV radiations of sunlight.</p> <p>5.2.3 The color should be such that any two seals should not show any visual color shade difference.</p> <p><b>5.2.4</b> The required shade of color shall be given/mentioned in the PO.</p>
<b>5.3</b>	<b>Marking/ Monogram</b>	<p>The seal shall have laser etched printing of monogram of <b>MVVNL</b> on front side and month and year embossed of manufacture in figure on the backside. The laser etched printing should be through complete thickness of polycarbonate.</p>

5.4	<b>Seal material</b>	<p>The raw material used for polycarbonate plastic seals shall be M/s GE plastic, (Grade 143R or 943 AA), any other equivalent manufacturer having similar material properties as under:</p> <table border="1" data-bbox="597 310 1485 646"> <thead> <tr> <th data-bbox="597 310 743 384">Sr. No</th> <th data-bbox="743 310 1076 384">Item</th> <th data-bbox="1076 310 1485 384">Polycarbonate</th> </tr> </thead> <tbody> <tr> <td data-bbox="597 384 743 457">1</td> <td data-bbox="743 384 1076 457">Melting Temperature</td> <td data-bbox="1076 384 1485 457">2800 C to 2950 C</td> </tr> <tr> <td data-bbox="597 457 743 495">2</td> <td data-bbox="743 457 1076 495">USE</td> <td data-bbox="1076 457 1485 495">Engineering</td> </tr> <tr> <td data-bbox="597 495 743 533">3</td> <td data-bbox="743 495 1076 533">Softness</td> <td data-bbox="1076 495 1485 533">Hard</td> </tr> <tr> <td data-bbox="597 533 743 571">4</td> <td data-bbox="743 533 1076 571">Durability</td> <td data-bbox="1076 533 1485 571">Weather effect resistant</td> </tr> <tr> <td data-bbox="597 571 743 646">5</td> <td data-bbox="743 571 1076 646">Transparency</td> <td data-bbox="1076 571 1485 646">Fully Transparent ( long time transparency)</td> </tr> </tbody> </table>	Sr. No	Item	Polycarbonate	1	Melting Temperature	2800 C to 2950 C	2	USE	Engineering	3	Softness	Hard	4	Durability	Weather effect resistant	5	Transparency	Fully Transparent ( long time transparency)
Sr. No	Item	Polycarbonate																		
1	Melting Temperature	2800 C to 2950 C																		
2	USE	Engineering																		
3	Softness	Hard																		
4	Durability	Weather effect resistant																		
5	Transparency	Fully Transparent ( long time transparency)																		
5.5	<b>Seal Wire</b>	<p>The non-corrosive, non-magnetic stainless steel twisted wire (26 guage) confirming to IS : 280 shall be used . The seal wire shall not have effect of magnet i.e. it should not attract to magnet. The length of the sealing wire should be minimum 6” twisted two strand pull resistant stainless steel wire fixed to the seal. The diameter of each individual stand should be of 0.46mm (26 gauge) to 0.5 mm. dia and overall diameter of the seal wire shall be 0.92 to 1.0 mm (<math>\pm 0.05</math>). The No. of turns shall be minimum 20 per inch. The seal wire should be inserted at the female and male part during the process of moulding itself and with a visible projected and continuously length of the wire. The wire shall be intact such that it cannot be pulled out after sealing. The seal wire insert hole should be just sufficient for passing the seal wire and hole of larger dia. is discouraged.</p>																		
5.6	<b>Tolerance</b>	Any dimension Tolerance shall be max. 0.5mm or below.																		
5.9	<b>Special feature</b>	<p>A secret code shall be given in each seal by bidder on whom the <b>MVVNL</b> places the order. The name of the bidder embossed/laser printed on the seals along with <b>MVVNL</b> logo, Sr. No., Month and Year of manufacture or any other symbol given by the <b>MVVNL</b> shall be embossed/ laser printed. Before commencing mass manufacturing &amp; supply Six Nos. of sample seals of each color shall have to be approved from the purchaser.</p>																		
5.10	<b>Patent</b>	<p>Seals should be patented, or design is registered with patent office. Copy of patent certificate /lease &amp; patent drawing/design should be submitted for verification along with the offer. This should comply to the latest CEA guidelines &amp; its Bidders responsibility to provide genuine documents complying to statutory guidelines.</p>																		
6.0	<b>NAME PLATE AND MARKING</b>	<p>Seals shall have embossed marking clearly visible and effectively secured against removal. Following marking to be done on seals.</p> <ol style="list-style-type: none"> <li data-bbox="487 1686 1494 1724">i. Manufacturer’s name on female part side below date &amp; month</li> <li data-bbox="487 1724 1494 1797">ii. Serial number – unique seven digit no (Seal serial number shall be laser printed on top of the male part &amp; bottom of the female part).</li> <li data-bbox="487 1797 1494 1871">iii. <b>MVVNL</b> monogram with logo on high-rise moulding in 8mm dia. On side of female part</li> <li data-bbox="487 1871 1494 1936">iv. Month and Year of manufacture in MM/YY format on other side of the female part in high-rise moulding in 8mm dia.</li> </ol>																		

7.0	<b>TESTS</b>	All routine, acceptance & type tests shall be carried out on the seals separately in accordance with the relevant IS/IEC. All routine/acceptance tests shall be witnessed by the purchaser/his authorized representative. All the components shall also be type tested as per the relevant standards. Following tests shall be necessarily conducted
7.1	<b>TYPE TEST</b>	As per acceptance tests.
7.2	<b>ROUTINE TEST</b>	<ol style="list-style-type: none"> <li>1. Dimension check – Dimensions as per approved GTP &amp; within min. tolerances in specs.</li> <li>2. Surface finish- Male &amp; female part – The surface should be free from any burr or casting voids etc.</li> <li>3. Embossing quality- embossing should have superior quality &amp; good finish.</li> <li>4. Colour shade- the colour shades of all seals of specific color should be same.</li> <li>5. The steel seal wire shall be properly placed in insulating material.</li> </ol>
7.3	<b>ACCEPTANCE TEST</b>	<p>The seals shall be inspected / tested as a acceptance test at the manufacture's works before dispatch in presence of authorized representative of purchaser for the following tests:</p> <ol style="list-style-type: none"> <li>i) <b>Physical Dimensional Check-up</b> : The seals shall be subjected to visual check-up for verification of workmanship and other features as mentioned above including shape / design / dimensions as per approved drawing /Samples &amp; dimensions should be within min. tolerances mentioned in specs./drawings.</li> <li>ii) <b>Boiling Water Test:</b> The seal when immersed in the boiling water for two hours there shall not be any effect on the seal and it shall remain intact condition i.e. the seal should not become soft, but instead should turn out to trail and easily break thus showing easily the tampering signs if it eventually happens. Even, with the help of any sharp instrument, pulling with plier i.e. by applying mechanical force, the male portion shall not come out from the female part (body seal). In case, it comes out, the same shall damage the seal, so that it cannot be re-used.</li> <li>iii) <b>Pull Out Test:</b> After locking the seal, if the male part / insert is pulled with mechanical force with the help of plier or any other instrument, sharp instrument etc. at normal condition, the seal should not get unlocked without any damage and when such condition occurs, it should leave traces of tampering.</li> <li>iv) <b>Seal Wire</b> : In case, if someone tries to pull the seal wire and in any of the tests as mentioned above at (ii) &amp; (iii) in that case the male / female portion of the seal should be damaged and the same can be seen visually being a transparent one.</li> <li>v) <b>Chemical Test:</b> The seal be kept in the concentrated acid for minimum one hour. The same shall remain in tact condition and if try to unlock the seal, the same shall be damaged.</li> <li>vi) <b>Temperature withstand test:</b> The seal should be capable to withstand temperature up to 147 deg. C without damage/deformation.</li> </ol>

		<p>vii) <b>Effect of oil, chemical &amp; sunlight</b> : The seal shall be so designed made that there shall not be any effect of temperature, chemicals, oil and sunlight etc. on the performance of the seal.</p> <p>Other checks -</p> <ol style="list-style-type: none"> <li>1. Surface finish- Male &amp; female part – The surface should be free from any burr or casting voids etc.</li> <li>2. Embossing quality- embossing should have superior quality &amp; good finish.</li> <li>3. Colour shade- the colour shades of all seals of specific color should be same.</li> <li>4. Marking &amp; embossing - The LOGO embossing shall be as per <b>MVVNL</b> standard logo &amp; making as mentioned in specs. The steel seal wire shall be properly placed in insulating material.</li> </ol> <p>In short, if the seal is tested for any of the above tests, in no condition the male and female part shall be separated out without affecting / damaging the seal. In case, if they are separated, the seal shall have sufficient tamper evident. Also, if seal wire is pulled out from the seal in any of the above tests, it shall not come out from the seal without damaging seal.</p>
7.4	<b>Sampling Plan</b>	<p>For carrying out above acceptance tests at manufacturer's works shall be Selected at the rate of 0.2% of the offered quantity with minimum 5 samples selected at random from the each lot offered as per IS4905. The seals used in testing shall be destroyed in the presence of <b>MVVNL</b> Inspecting Officer.</p>
8.0	<b>TYPE TEST CERTIFICATE</b>	<p>The bidder shall furnish the type test certificates of the meter for the tests as mentioned above as per the corresponding standards. All the tests shall be conducted at CPRI or ERDA or UL or accredited laboratory as per the relevant standards. Testing from any national approved laboratory or international acclaimed lab or equivalent will also suffice at the discretion of <b>MVVNL</b>. Type test should have been conducted in certified Test Laboratories during the period not exceeding 5 years from the date of opening the bid. In the event of any discrepancy in the test reports i.e. any test report not acceptable or any/all type tests (including additional type tests, if any) not carried out, same shall be carried out without any cost implication to <b>MVVNL</b>.</p>
9.0	<b>PRE-DESPATCH INSPECTION</b>	<p>The successful bidder shall submit Six samples of each color seal (non-returnable) mentioned in tender/ PO for further testing and compliance as per specifications and getting approval before mass manufacturing. Out of Six samples, five samples to be submitted in Meter testing lab and one in <b>MVVNL</b>.</p> <p>Inspection may be made at any stage of manufacture at the discretion of the purchaser and if found unsatisfactory as to workmanship or material, the same is liable to rejection.</p> <p>Equipment shall be subject to inspection by a duly authorized representative of the Purchaser. Bidder shall grant free access to the places of manufacture to <b>MVVNL</b>'s representatives at all times when the work is in progress. Inspection by the <b>MVVNL</b> or its authorized representatives shall not relieve the bidder of his obligation of furnishing</p>

		<p>equipment in accordance with the specifications. Material shall be dispatched after specific MDCC (Material Dispatch Clearance Certificate) is issued by <b>MVVNL</b>.</p> <p>Following documents shall be sent along with material</p> <ol style="list-style-type: none"> <li>Test reports</li> <li>MDCC issued by <b>MVVNL</b></li> <li>Invoice in duplicate</li> <li>Packing list</li> <li>Drawings &amp; catalogue</li> <li>Guarantee / Warrantee card</li> <li>Delivery Challan</li> <li>Other Documents (as applicable)</li> </ol> <p>Stage Inspection: If desired by <b>MVVNL</b>, <b>MVVNL</b> will arrange stage inspection for the material used for manufacturing of seal and also during the process of manufacturing. If desired, during the surprise checking <b>MVVNL</b> shall take sample of raw material and will check for the material properties. In case, the same is not found as per the specification, the entire lot under process shall be rejected.</p>
<b>10.0</b>	<b>INSPECTION AFTER RECEIPT AT STORE</b>	The material received at Purchaser's store shall be inspected for acceptance and shall be liable for rejection, if found different from the reports of the pre-dispatch inspection or approved GTP & drawings and one copy of the report shall be sent to the <b>MVVNL</b> .
<b>11.0</b>	<b>GUARANTEE</b>	Bidder shall stand guarantee towards design, materials, workmanship & quality of process / manufacturing of items under this contract for due and intended performance of the same, as an integrated product delivered under this contract. In the event any defect is found by the purchaser up to a period of at least 24 months from the date of commissioning or 30 months from the date of last supplies made under the contract whichever is earlier, Bidder shall be liable to undertake to replace/rectify such defects at its own costs, within mutually agreed time frame, and to the entire satisfaction of the Company, failing which the purchaser will be at liberty to get it replaced/rectified at bidder's risks and costs and recover all such expenses plus the Company's own charges (@ 20% of expenses incurred), from the bidder or from the " Security cum Performance Deposit" as the case may be.
<b>12.0</b>	<b>PACKING</b>	The bidder shall be responsible for suitable packing of seals, colour wise. The bidder shall have to supply each 100 seals in chronological order i.e. arranging in serially, tied with the steel wire forming a loop and same shall be packed in polythene bag with labels furnishing serial no., colour etc. & further packed in cardboard boxes for safety in transit.
<b>13.0</b>	<b>TENDER SAMPLE</b>	<p>Bidders are required to manufacture 05 sample seals of each colour as per the <b>MVVNL</b> specification and submit (non-returnable) the sample along with bid for approval. These samples to be submitted in Meter Testing Lab &amp; intimated to <b>MVVNL</b>.</p> <p>The tender sample seals shall be provided with trademark and logo of firm on front side &amp; month and year of manufacturing on back side of the female part of the seal. The offer without samples shall be out rightly</p>



		rejected and the offer shall not be considered. The samples seals shall be tested as per the specifications, either in <b>MVVNL</b> 's laboratory or at third party govt approved laboratory, as per the discretion of <b>MVVNL</b> . The tender sample seals not conforming to the specifications shall be straight war rejected and accordingly, their offer will not be considered for further evaluation.
<b>14.0</b>	<b>QUALITY CONTROL</b>	<p>The bidder shall submit with the offer Quality assurance plan indicating the various stages of internal factory inspections, tests and checks which will be carried out on the material of construction, components during manufacture and bought out items and after finishing final product.</p> <p>Quality should be ensured at the following stages:</p> <ul style="list-style-type: none"> <li>• Inwards raw material</li> <li>• At Female part moulding along with seal wire</li> <li>• At male part moulding with seal wire</li> <li>• On finished product</li> <li>• Prior to packing</li> </ul> <p>The <b>MVVNL</b>'s engineer or its nominated representative shall have free access to the bidder's/manufacturer's works to carry out inspections of QAP.</p>
<b>14.1</b>	<b>IDENTIFICATION OF DUPLICATES</b>	<p>Supplier shall ensure that process cannot be duplicated to prevent duplicate seals.</p> <p>However, in case <b>MVVNL</b> finds any doubtful seal at site, manufacturer shall visit the site for certifying whether the seals are genuine or duplicate.</p> <p>Manufacturer shall give a letter stating reason's for duplicate and technical report needs to be provided along with conclusions. A copy of the report should be sent to Plant Egg. Department.</p>
<b>15.0</b>	<b>MINIMUM TESTING FACILITIES</b>	Bidder shall have adequate in house testing facilities for carrying out all routine tests & acceptance tests as per relevant International / Indian standards/ <b>MVVNL</b> specification. The bidder shall have good/digital/calibrated instruments to check minute difference in dimensions & logo etc.
<b>16.0</b>	<b>MANUFACTURING ACTIVITIES</b>	The successful bidder will have to submit the bar chart for various manufacturing activities clearly elaborating each stage, with quantity. This bar chart shall be in line with the Quality assurance plan submitted with the offer. This bar chart will have to be submitted within 15 days from the release of the order.
<b>17.0</b>	<b>SPARES, ACCESSORIES AND TOOLS</b>	Not Applicable
<b>18.</b>	<b>SEAL WITH TRACKING &amp; RECORDING SOFTWARE</b>	<p>As per relevant regulations, seal tracking and recording software for all new seals shall be provided by the meter manufacturer. The software shall have following features</p> <ul style="list-style-type: none"> <li>• Software should have facility of defining the system controller</li> <li>• Facility to enter serial number of seals with the help of bar code scanner.</li> <li>• Receiving of seal in the system and with authentication like signature.</li> </ul>

		<ul style="list-style-type: none"> <li>• Facility to identify the concern who is responsible for receiving of seals and nominated by system supervisor.</li> <li>• Provision to define different type of seals for various uses.</li> <li>• Software should have facility of report generation for inventory &amp; issue records.</li> <li>• Facility to track for relevant data for individual seal entered in the system.</li> </ul>																																			
<p><b>19.0</b></p>	<p><b>DRAWINGS AND DOCUMENTS</b></p>	<p>Following drawings &amp; Documents shall be prepared based on <b>MVVNL</b> specifications and statutory requirements and shall be submitted with the bid:</p> <ol style="list-style-type: none"> <li>Completely filled-in Technical Parameters.</li> <li>General arrangement drawing of the meter</li> <li>Terminal Block dimensional drawing</li> <li>Mounting arrangement drawings.</li> <li>General description of the equipment and all components with makes and technical requirement</li> <li>Type Test Certificates</li> <li>Experience List</li> <li>Manufacturing schedule and test schedule</li> </ol> <p>After the award of the contract, soft copies or hard copies of following drawings, drawn to scale, describing the equipment in detail shall be forwarded for approval:</p> <table border="1" data-bbox="621 961 1508 1499"> <thead> <tr> <th>S. No.</th> <th>Description</th> <th>For Approval</th> <th>For Review Information</th> <th>Final Submission</th> </tr> </thead> <tbody> <tr> <td>1</td> <td>Technical Parameters</td> <td>√</td> <td></td> <td>√</td> </tr> <tr> <td>2</td> <td>General Arrangement drawings</td> <td>√</td> <td></td> <td>√</td> </tr> <tr> <td>3</td> <td>Manual/Catalogues</td> <td></td> <td>√</td> <td></td> </tr> <tr> <td>4</td> <td>Transport/ Shipping dimension drawing</td> <td></td> <td>√</td> <td>√</td> </tr> <tr> <td>5</td> <td>QA &amp; QC Plan</td> <td>√</td> <td>√</td> <td>√</td> </tr> <tr> <td>6</td> <td>Routine, Acceptance and Type Test Certificates</td> <td>√</td> <td>√</td> <td>√</td> </tr> </tbody> </table> <p>All the documents &amp; drawings shall be in English language.</p> <p>Instruction Manuals (If applicable) : Bidder shall furnish softcopies and one hard copies of nicely bound manuals (In English language) covering instructions for use &amp; application and all relevant information and drawings pertaining to the main equipment as well as auxiliary devices if any.</p>	S. No.	Description	For Approval	For Review Information	Final Submission	1	Technical Parameters	√		√	2	General Arrangement drawings	√		√	3	Manual/Catalogues		√		4	Transport/ Shipping dimension drawing		√	√	5	QA & QC Plan	√	√	√	6	Routine, Acceptance and Type Test Certificates	√	√	√
S. No.	Description	For Approval	For Review Information	Final Submission																																	
1	Technical Parameters	√		√																																	
2	General Arrangement drawings	√		√																																	
3	Manual/Catalogues		√																																		
4	Transport/ Shipping dimension drawing		√	√																																	
5	QA & QC Plan	√	√	√																																	
6	Routine, Acceptance and Type Test Certificates	√	√	√																																	

20.0	GUARANTEE D TECHNICAL PARTICULAR S	Sr. No.	PARTICULARS	TO BE FURNISHED BY BIDDER
		1	Name & address of manufacturer	
2	Work's address			
3	Raw material of polycarbonate seals			
4	UV resistance properties			
	Seal shall not be affect by boiling water & acid			
5	Seal should have 6 inch long 26 gauges, twisted strand stainless steel wire non corrosive & non magnetic			
6	Max. Withstand temperature (upto 147deg.c.)			
7	Thickness of seal			
8	Serial number should be laser printed on male & female part & should be separately visible after closing of seal			
9	Embossing of monogram is as Per specification			
10	Colour of the seals			
11	Seal should be constructed/moulded with one piece twisted sealed wire & polycarbonate male & female part such way that no extra seal wire is required.			
12	Seal design should be such that once seal is closed, the two parts should not be separated.			
13	Seal should permanently secure steel wire inside seal after closing of male & female part.			
14	Seal should have positive locking & locking should be easy & should be possible with pressure of thumb.			
15	<ol style="list-style-type: none"> <li>1. Surface finish- Male &amp; female part – The surface should be free from any burr or casting voids etc.</li> <li>2. Embossing quality- embossing should have superior quality</li> <li>3. Colour shade- the colour shades of all seals of specific color should be same.</li> </ol>			
16	Guarantee of seal			
17	SEAL IS PATENTED (Provide patent no. & patent drawing/design along with			

			COPY OF PATENT certificate.							
		18	Seal wire details							
		19	Supplier should have supplied minimum 1 lakh such seals to power utility. Give details.							
		20	a. Color of female part b. Color of male part							
		21	Manufacturer specific secret code - (Yes/No)							
<b>21.0</b>	<b>SCHEDULE OF DEVIATIONS</b>	<b><u>(TO BE ENCLOSED WITH THE BID)</u></b>								
		<p>All deviations from this specification shall be set out by the Bidders, clause by Clause in this schedule. Unless specifically mentioned in this Schedule, the tender shall be deemed to confirm the purchaser's specifications:</p> <table border="1" style="margin-left: auto; margin-right: auto;"> <thead> <tr> <th style="text-align: center;">S.No.</th> <th style="text-align: center;">Clause No.</th> <th style="text-align: center;">Details of deviation with justifications</th> </tr> </thead> <tbody> <tr> <td> </td> <td> </td> <td> </td> </tr> </tbody> </table> <p>We confirm that there are no deviations apart from those detailed above.</p> <p>Seal of the Company:</p> <p style="text-align: right;">Signature</p> <p style="text-align: right;">Designation</p>			S.No.	Clause No.	Details of deviation with justifications			
S.No.	Clause No.	Details of deviation with justifications								
<b>22</b>	<b>AUTHORISED SUPPLY UNDERTAKING</b>	<b><u>(TO BE ENCLOSED WITH THE BID)</u></b>								
		<p>On award of contract the bidder should not sell or offer the seals with <b>MVVNL</b> logo to any unauthorized person outside <b>MVVNL</b> in any circumstances.</p> <p>We confirm that we or any our company representative shall not offer to sell the <b>MVVNL</b> logo seals to any unauthorized person outside <b>MVVNL</b>.</p> <p>Seal of the Company:</p> <p style="text-align: right;">Signature</p> <p style="text-align: right;">Designation</p>								

---

## **Annexure U: Specification of Piercing Connectors.**

### **5.1 Piercing Insulator:**

- 5.1.1 Insulation Piercing Connectors (IPC) are used for making Tee/Tap-off/Service connectors to an ABC/Bare Overhead Line.
- 5.1.2 Insulation Piercing Connectors are designed to make a connection between the uncut main conductor and a branch cable conductor without having to strip either cable to expose the conductor instead the tightening action of the IPC will first pierce the Insulation, then make good electrical contact between the main end and branch conductor while simultaneously insulating and sealing the connection.
- 5.1.3. Constructional Features of IPC
  - 5.1.3.1 The housing shall be made entirely of mechanical and weather resistant plastic insulation material and no metallic part outside the housing is acceptable except for the tightening bolt.
  - 5.1.3.2 Any metallic part that is exposed must not be capable of carrying a potential during or after connector installation.
  - 5.1.3.3 Screws or nuts assigned for fitting with IPC (Insulating Piercing connector), must be fitted with torque limiting shear heads to prevent over tightening or under tightening (min & max torque values to be specified by Manufacturer).
  - 5.1.3.4 The IPC must perform piercing and connection on Main and Branch cable simultaneously.
  - 5.1.3.5 The IPCs shall be water proof and the water tightness shall be ensured by appropriate elastomer materials and not by grease, gel or paste alone.
  - 5.1.3.6 Design of IPC should be such as to not cause damage to insulation of adjacent conductors due to vibration and relative movement during service.
  - 5.1.3.7 The connector shall have a rigid removable end cap which can be slide fitted onto the main connector body on either right or left by the installer (depending on site requirement) for sealing the cut end of the branch cable. Once the connector is fitted, it should not be possible to remove the cap without removing the connector.
  - 5.1.3.8 All the metallic parts of the connector should be corrosion resistant and there should not

be any appreciable change in contact resistance & temperature after overloads & load cycling.

- The contact plates should be made of aluminium alloy.
- Connector teeth should be factory greased & sealed to retard water or moisture ingress & corrosion.
- The Insulation material should be made of weather & UV resistant reinforced polymer.
- The outer metallic part should have potential free tightening bolts to allow safe installation on live lines.

#### 5.1.4. Mechanical Tightening and Electrical Continuity

5.1.4.1 Connectors shall be tightened upto 70% of the minimum torque indicated by the Manufacturer. At this torque electrical contact should have occurred between conductors to be joined. Then connectors shall be tightened up to the breakdown of the shear heads and lastly, upto 1.5 times the maximum torque indicated by the manufacturer.

For the connector fitted with two screws on the same core, after the breakdown of the shear heads tightening may be carried out manually and alternatively using a torque meter. The test conditions shall be as close as possible to those defined for the use of the test machine as per NF-C standard.

5.1.4.2 At 1.5 times the maximum torque indicated by the manufacturer, there shall be no breakdown of any part of the connector or the core conductor.

5.1.4.3 Maximum rated torque shall not exceed 20 N.m for conductor <95 sq.mm and 30 for >95 but <150 sq.mm.

5.1.4.4 Tightening screws shall have hex. Heads of 10 mm, 13 mm or 17 mm only.

#### 5.1.5. Effect of Tightening on Main Core of IPC

5.1.5.1 The connector shall be fitted approx. at the centre of the main core, which is secure between two anchoring points 0.5 mtr. To 1.5 mtr.apart. At the time of fitting the connectors, the main core shall be under longitudinal tension at 20% of the load indicated in Table-1:

<b>Table-1</b>	
<b>Nominal Cross – section (sq.mm.)</b>	<b>Tensile Strength (Newton)</b>
16	1200
25	1800
35	2500
50	3500

70	5000
150	10000

5.1.52 Tensile strain shall be increased to the full value indicated in the Table 1 and held minute. There should be no breakdown of the core conductor.

5.1.6. Effect of Tightening on Branch Core of IPC

5.1.6.1 Test specimen shall be made up as in clause 5.1.5.1 except that this shall be do the smallest cross sections of main and branch conductors within its range.

5.1.6.2 An increasing tensile load shall be applied to the Branch Conductor along the axis of the recess for the Branch cable. Load shall increase at 100 – 500 N/minute until it reaches the value specified in the Table 2 and maintained for 1 minute.

<b>Table-2</b>	
Nominal Cross – section (sq.mm.)	Tensile Strength (Newton)
16 (Alu)	290
25	450
35 & above	500

5.1.6.3 No slippage or breaking of conductor shall occur.

5.1.7. Dielectric & Water Tightness Test of IPC

5.1.7.1 The connector is tightened up to the minimum torque indicated by the manufacturer.

5.1.7.2 Connectors are mounted on

- Minimum cross section of main core.
- Maximum cross section of main core.

5.1.7.3 In each case Branch is of minimum cross section.

5.1.7.4 Protection caps for the branch cable are to be used in accordance with the requirements of clause

5.1.3.7. An additional water tight cap of any design may be used to seal one end of the main cable if it is immersed under water. No additional gel or any protection is to be provided while installing connector.

5.1.7.5 The entire assembly shall be immersed at a depth of approx. 30cms. For 30 minutes with the free ends of main and branch cable out of the water.

5.1.7.6 An AC voltage of 6 kV shall be applied between the water bath and each of the cores in turn for 1 minute. There shall be no flashover or electrical tripping with a

trip setting of 10 mA + 0.5mA.

5.1.8. Electrical & Ageing Test of IPC

5.1.8.1 Two test configurations are used according to Table 3 with the connections tightened to the minimum torque specified by their manufacturers and resistance recorded.

Configuration	Main core cross section	Branch core cross section Tensile Strength (K.N)
1st Configuration	Maximum	Maximum
2nd Configuration	Maximum	Maximum

5.1.8.2 The configurations are subjected to 200 heat cycles by injecting suitable current into them. In each cycle the temperature of the conductor shall be raised from ambient to  $120 + 5^{\circ}\text{C}$  as, measured by a thermocouple.

5.1.8.3 The duration of each heating cycle is chosen to maintain a sufficiently steady temperature of  $120 + 5^{\circ}\text{C}$  for 15 minutes. The duration of each cooling cycle is chosen to bring the conductor temperature to within  $2^{\circ}\text{C}$  of ambient.

5.1.8.4 Nominal heating current is indicated in the Table-4. It shall be permissible to accelerate the temperature rise by using a current up to 1.5 times the nominal current and to accelerate the cooling period by use of a fan or air blower.

Nominal Cross – section (sq.mm.)	Nominal Heating Current (A)
16	102
25	139
35	175
50	225
70	283
95	350
120	412
150	480
185	545
240	670

5.1.8.5 The over current test of Clause 5.1.9 shall be done after 50 cycles if the connector is a safety connector designed to ground a phase connector while the line is being worked on.



- 5.1.8.6 At the end of the 200 cycles the resistance shall again be measured. It shall not differ from the initial value by more than 12%.

### 5.1.9. Over Current Test of IPC

5.1.9.1 Over current test is required to establish the performance of Safety Connectors that are intended to provide a safe path to ground for the phases while the line is de-energised for working. It establishes the performance of the connector under short term over load conditions.

5.1.9.2 After the first 50 cycles of clause 5.1.8, the connectors are subjected to 4 over currents of 1 sec duration each.

5.1.9.3 The conductor temperature at the start of the over current test should be not more than 35°C.

5.1.9.4 Current density during over current shall be 100 A/sq.mm for Aluminium and 95 A/sq.mm for Aluminium – Alloy Conductor.

5.1.9.5 Variation in time of over current is permissible between 0.85 sec & 1.15 sec., provided it maintains the relationship  $I^2 t = K$

$t = K$  where,

$I$  = rms value of over current in Amps.  $t$  = time in seconds

$K$  = Constant

5.1.9.6 After the over current test the electrical ageing test of clause 5.1.8 shall be resumed.

### 5.1.10. Type Test of IPC

5.1.10.1 Type Test Reports should be submitted from an Independent Laboratory of Repute or the Works Laboratory in case of a foreign manufacturer covering the following (on any convenient size of fitting of same design made from the same materials).

5.1.10.2 The installation of the connectors shall be done by the laboratory following instructions provided by the manufacturer.

5.1.10.3 The Test report shall record the embossing and marking on the connector.

5.1.10.4 The following shall constitute Type Tests for IPC :

- Electrical Ageing Test
- Dielectric and Water Tightness Test.
- Mechanical Tightening Test
- Effect of Tightening on main Core
- Effect of Tightening on Branch core
- Over-current Test (if applicable)

The following shall be Type Test for Suspension Assembly (SA)

- Mechanical Test
- Voltage Test
- Climatic Aging Test
- Corrosion Test
- Endurance Test under Thermal & Mechanical Stresses

The following shall be Type Tests for Anchoring Assemblies (AA)

- Mechanical Test
- Voltage Test
- Dynamic Test
- Climatic Aging Test
- Corrosion Test
- Endurance Test under Thermal & Mechanical Stresses

## 5.2 Anchoring Clamp for Insulated Messenger:

The clamps should be designed to Anchor LT-AB cable with insulated messenger. The clamp should consist of an Aluminium alloy corrosion resistant castled body, bail of stainless steel and self adjusting plastic wedges which shall anchor/hold the neutral messenger without damaging the insulation.

-

- No losable part in the process of clamping arrangement
- The clamp should conform to the standard NFC 33041 and 33042 or equivalent I.S. if any.
- The clamp body should be made of corrosion resistant Aluminium alloy, bail should be of stainless steel and wedges should be weather and UV resistant polymer.
- Ultimate tensile strength of the clamp should not be less than 15 kN for 50/70sq.mm insulated messenger wire / 10 kN for 25/35 sq.mm insulated messenger wire.
- Slip load of the clamp should not be less than 3 kN for 50/70 sq.mm. messenger wire / 2 kN for 25/35 sq.mm. messenger wire.

5.2.1 Anchoring assemblies are used to firmly attach the messenger of ABC to a support and transmit the mechanical tension.

- at the end of a run or to the supporting structures
- at a major change in direction.

5.2.2 Each Anchoring Assembly shall include.

- One number tension bracket.
- One number wedge type tension clamp
- Flexible Rope for fixing tension clamp to bracket.

5.2.3 Anchoring assemblies shall be supplied in sets to ensure compatibility of the materials against

cor

rosion or wear of moving parts.

### 5.2.1 Tension Bracket of AA

5.2.4.1 The tension bracket shall be made out of a single piece of Aluminium alloy suitable for attachment to a pole either by

- a) 16mm galvanized steel bolt (s) or
- b) two stainless Steel straps of 20 x 0.7 mm.

5.2.4.2 The tension bracket should be designed to ensure the Flexible rope cannot slip out at any angle.

5.2.4.3 The tension bracket should be rated and tested for the loads specified in Table-5. The load shall be applied at an angle of 45° from the normal to the surface of mounting of the bracket.

<b>Table - 5</b>			
<b>Conductor Size (Sq.mm.)</b>	<b>Rating</b>	<b>Load for deformation &lt;10mm (Newtons)</b>	<b>Load for deformation &lt;30mm &amp; no-break (Newtons)</b>
25-35	1500 Kg.	12,000	15,000
50-95	2000Kg	15,600	19,500

### 5.2.5 Flexible Rope of AA

5.2.5.1 The Anchoring assembly shall be supplied with a stainless steel flexible Rope to connect the Tension Clamp to the Tension Bracket.

5.2.5.2 The rope should have sufficient flexibility to ease the torsional movement of the ABC System.

5.2.5.3 The Rope should be pre-fitted with compression type end fittings to secure the tension clamp.

5.2.5.4 A wear resistant moveable saddle should be un-loosably fitted on the Rope to prevent abrasion at the point of fitting into the tension bracket.

5.2.5.5. The Rope should have sufficient mechanical strength to withstand the mechanical test for the complete assembly tests in this specification.

### 5.2.6 Wedge Type Tension Clamp of AA

5.2.6.1 Wedge type clamps shall be used for clamping the messenger without damaging the

insulation.

- 5.2.6.2 The clamp shall be capable of clamping an uncut messenger so that it can continue without break to the connecting point or next span.
- 5.2.6.3 The clamp shall be fully insulating type of mechanical and weather resisting thermoplastic.
- 5.2.6.4 No bolts or loose parts are allowed as part of the Clamping system.
- 5.2.6.5 No tools shall be needed for fitting the messenger into the clamp.
- 5.2.6.6 The clamp shall be self tightening and capable of holding without slippage the load specified in the Table-6.

<b>Table - 6</b>				
Conductor Size		Rating (Kg.)	T start (1 minute) (Newtons)	T final (1 minute) (Newtons)
Sq. mm.	Dia. (mm)			
25-35	8-11	1000 Kg.	8,000	10,000
50-54	8-11	1500 Kg.	12,000	15,000
70-95	13.5-16	2000 Kg.	12,000	15,000

- 5.2.6.7 After fitting the insulated messenger in the clamp, load T start will be held for 1 minute & then load increased to T final at rate between 5000 – 7,500 N/mtr. In each case there shall be no breakdown of any part of clamp and slippage of messenger in relation to the clamp.
- 5.2.7 Voltage Test on Clamp of AA
- 5.2.7.1 Voltage test is carried out on anchor clamps to ensure no damage is caused to the insulated messenger.
- 5.2.7.2 A conductive rod of dia. corresponding to the average dia. that can be accommodated in the clamp is fitted into the clamp, protruding by approx. 50mm at each end of the tightening piece.
- 5.2.7.3 The rod and clamp is subjected to tensile load as stated in Table 7 below when fixed to a support in its normal manner.

<b>Table - 7</b>			
Conductor Size		Normal rating (kg)	Load Applied (N)
Sq. mm.	Dia. (mm)		
25-35	8-11	1000	2000

50-54	8-11	1500	4000
70-95	13.5-16	2000	4000

- 5.2.7.4 A power frequency voltage of 6 kV is applied for 1 minute between the rod and conductive part of the clamp, or fixation point in absence of conductive part.
- 5.2.7.5 No breakdown or flashover shall occur. There shall be no tripping due to leakage with a setting of 10 +0.5 mA.
- 5.2.8 Endurance under Mechanical & Thermal Stress of AA
- 5.2.8.1 This test is done on clamp rated 1500 Kg. or 2000 Kg. using insulated messenger 50 to 70 sq. mm.
- 5.2.8.2 A neutral messenger is fitted between two anchor clamps, with clamp spacing approx. 5 mtr. & 1 mtr. Of messenger protruding from the end. Marks are made to enable measurement of slippage.
- 5.2.8.3 The sample is subjected to 500 cycles of 90 minutes each as described below:
- 5.2.8.3.1 Messenger temperature is raised by passing an AC current to 60 +30 C within 15 minutes. This temperature is maintained for at least 30 minutes to give a total heating period of 45 mts. per cycle.
- 5.2.8.3.2 Messenger is allowed to cool naturally to ambient for further 45 minutes to complete 90mts. Cycle time.
- 5.2.8.3.3 Mechanical load is applied during the cycle as per table 8 below. Load F1 is applied throughout the cycle, except for a short period of 5 sec. to 60 sec. when it is gradually increased from F1 to F2 at any time during the last 15 minutes of the 90 minute cycle.
- | <b>Table - 8</b> |           |              |              |              |
|------------------|-----------|--------------|--------------|--------------|
| Conductor Size   |           | Rating (Kg.) | F1 (Newtons) | F2 (Newtons) |
| Sq. mm.          | Dia. (mm) |              |              |              |
| 25-35            | 8-11      | 1000 Kg.     | 2,200        | 5,000        |
| 50-54            | 8-11      | 1500 Kg.     | 4,000        | 7,500        |
| 70-95            | 13.5-16   | 2000 Kg.     | 4,500        | 10,000       |
- 5.2.8.3.4 There should be no slippage greater than 4 mm after 2 cycles or greater than 8 mm after 500 cycles.
- 5.2.8.3.5 Voltage test is done at the end of the 500 cycles by immersing the test specimen of neutral messenger and clamps in water of resistivity not less than 200 Ohm mtr. For 30 minutes.
- 5.2.8.3.6 A voltage of 10 kV ac is applied for 1 minute between messenger and water bath using a trip setting of 10 + 0.5 am. There should be no breakdown or tripping.

### 5.3 Suspension clamp for insulated neutral messenger:

The clamp should be designed to hang L.T – AB cable with insulated neutral messengers. The neutral messengers should be fixed by an adjustable grip device. A movable link should allow longitudinal and transversal movement of the clamp body.

- No losable part in the process of clamping arrangement.
- The clamp should conform to the standard NFC 33040 or equivalent I.S, if any.
- The clamp and the link made of Polymer should provide an additional insulation between the cable and the pole.
- The clamps and movable links should be made of weather and UV resistant glass fibre reinforced polymer.
- Clamps should be fixed with pole by eye hook / bracket. Bracket should be made of corrosion resistant aluminium alloy.
- Ultimate tensile strength of the clamp should not be less than 15 KN for 50/70 sq.mm. Insulated messenger wire 4.3 KN for 25/35 sq.mm. Insulated messenger wire.
- Maximum allowable load of the clamp should not be less than 20 KN for 50/70 sq.mm. insulated messenger wire/15 KN for 25/30 sq.mm insulated messenger wire.

531 Suspension Assembly is used for supporting an ABC by installation on the messenger at an intermediate point of support such as a pole. It can accommodate small angles of deviation upto 30°.

532 Each Suspension Assembly shall consist of:

- One number Suspension Bracket.
- One number moveable (articulated) connecting link.
- One number Suspension Clamp.

533 Suspension Assemblies shall be supplied in sets to ensure compatibility of the materials against corrosion or wear of rotating/moving parts.

534 Suspension Bracket of SA

5.3.4.1 The Suspension Bracket shall be made from single piece aluminium alloy suitable for attachment to a pole by either.

- a) 16 mm galvanized steel bolt or
- b) Two stainless steel straps.

5.3.4.2 The Suspension Bracket shall be provided with an upper bulge to prevent the clamp from turning over on the Bracket for more than 45° from the horizontal or to within less than 60 mm from the pole / fixing structure.

5.3.4.3 The Suspension Bracket should be so designed to ensure that the articulated link cannot

slip out of it.

53.4.4 Suspension Brackets shall be designed to withstand a load applied at the anchoring point of the movable link as per Table – 9 below without deformation of more than 10mm or breakdown at 330 below horizontal (there should be no longitudinal component of load parallel to the plane of fixing).

<b>Table - 9</b>			
Conductor Size		Normal rating (kg)	Load (N)
Sq. mm.	Dia. (mm)		
25-35	8-11	1500Kg.	12500
70-95	13-17	2000Kg.	14000

535 Movable (Articulated) Link of SA

53.5.1 Movable Links are used between the Suspension Bracket and Suspension Clamp to allow a degree of movement and flexibility between the two.

53.5.2 Moveable Links should be made fully of insulating type of mechanical and weather resistant thermoplastic. A metallic wear resistant ring should however be fitted at point of contact between the Suspension Bracket and the movable link.

53.5.3 The Movable link should be unloosably fitted to the Bracket and the Clamp.

536 Suspension Clamp of SA

536.1 Suspension Clamps are used for locking the messenger of the ABC bundle without damaging the insulation or allowing the messenger to become dismantled from the fitting.

536.2 The Suspension Clamp shall accommodate messenger wires from 25 to 95 sq.m.

536.3 The Suspension Clamp shall be made fully of insulating type of mechanically strong and weather resistant plastic.

536.4 Bolts should not be used for clamping / locking the messenger in the Clamp.

536.5 There shall be no losable parts in the Suspension clamp.

536.6 The Suspension Clamp should be unloosably fitted to the rest of the Suspension Assembly.

537 Mechanical Test on Clamp of SA

5.3.7.1 The Sub Assembly shall be subjected to a vertical load applied as per drawing in accordance with Table-



10. There shall be no breakdown or permanent deformation at load T initial for 1 minute or when the load is increased to T final and released.

Conductor Size		Rating (Kg.)	T start (1 minute) (Newtons)	T final (1 minute) (Newtons)
Sq. mm.	Dia. (mm)			
25-54	8-15	1500 Kg.	9,600	12,000
70-95	13-17	2000 Kg.	12,800	16,000

Fig. : A

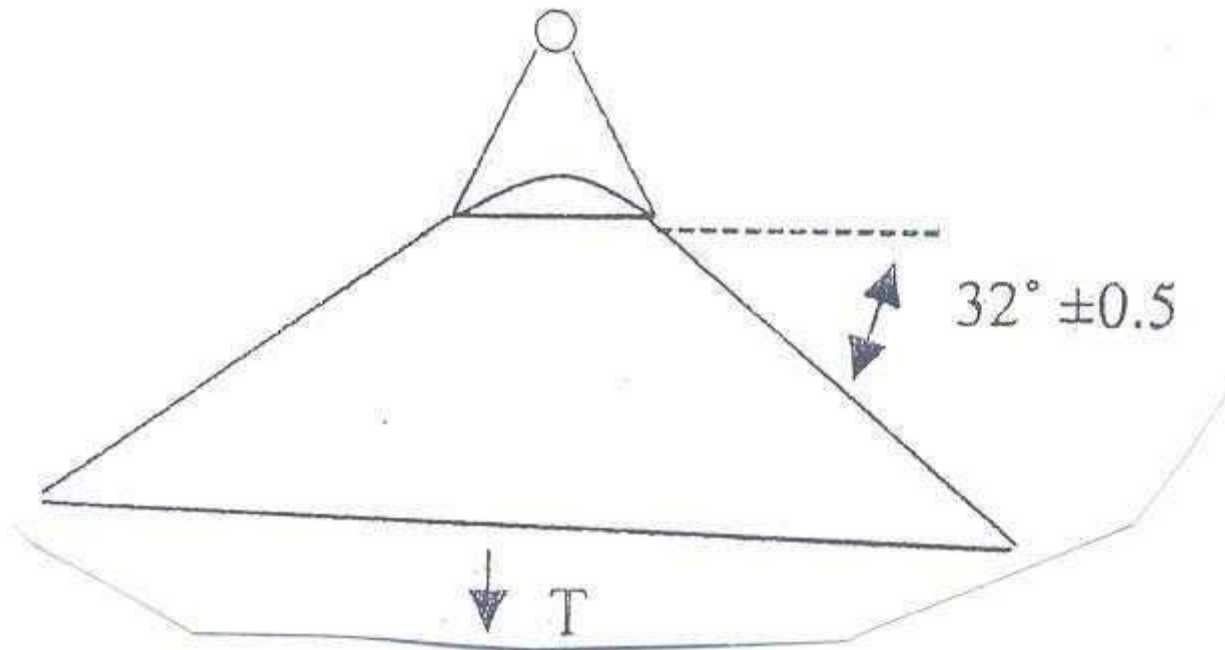

5.3.7.2 A sample messenger shall be fitted into a fixed suspension clamp and subjected to a gradually applied longitudinal load of 300 N. There shall be no permanent slippage.

538 Voltage Test of SA

A copper foil is wrapped at the clamping point around the maximum size of messenger allowed in that clamp. An ac voltage of 6 KV is applied between the copper foil and nearest conductive point of the clamp or into its absence to the point of fixation. The voltage should be withstood for 1 minute without breakdown or flashover.

## 539 Test Under Mechanical &amp; Thermal Stress

5391 The test specimen is made up of approx. 10mts. Of messenger wire strung between two anchor clamps with a Suspension Clamp fixed in the middle. Masses of 40 Kg. are suspended at a distance of 1-2mtr. On either side of the Suspension Clamp with a fixing mechanism of mass 2 + 1Kg.

5392 The specimen is subjected to 500 cycles of 90 minutes each. Each cycle consists of the following:

- a) For first 75 minutes a constant longitudinal tension of 4000 N is applied to the messenger for rating of 1500 Kg. and of 4500 N rating of 2000 Kg. while 64cycles right and left oscillation are produced on the clamp 32°on either side of the vertical.
- b) During the first 45 minutes an intermittent current of 4-5 A/sq.mm is applied to maintain the conductor temp at 60 + 3° C.
- c) During the next 45 minutes of the cycle the conductor is allowed to cool down naturally to the ambient.
- d) At the 75th minute, after having completed 64 oscillations, the oscillations are stopped and the longitudinal tension is increased to 7500 N for 1500 kg. Rating and 10000 N for 2000 Kg. Rating.

3.9.3 No messenger slippage should occur within the Suspension Clamp during the 500cycles.

5.3.9.4 At the end of the 500 cycles, the messenger is immersed in water for 30 minutes. It is then tested to withstand 10 kV ac for 1 minute with a trip setting of 10 + 0.5 mA. There should be no breakdown or flashover.

## 5.4 Acceptance Tests

541 The following shall constitute Acceptance Tests for Insulation Piercing Connectors(IPC) :

- Visual \*
- Dimensional (as per SCD and overall dimensions submitted with Tender Offer)\*
- Electrical Ageing Test \*\*\*
- Dielectric and Water Tightness Test. \*\*
- Mechanical Tightening Test \*\*
- Effect of Tightening on Main Core \*\*
- Effect of Tightening on Branch Core \*\*

The above tests are to be carried out as per sampling plan below. However electrical ageing test on IPC (market\*\*\*) is to be done on only one connector of each type and size.

In case of random failure/defect, double the sample lot is to be drawn and there should be no failure/defect exceeding half the permissible defects (rounded down) shown in the chart.

Lot Size	For tests Marked*		For tests Marked**	
	Sample Size	Max. permissible Defects	Sample Size	Max. permissible Defects
Upto 100	2	nil	2	nil
101 to 1000	6	nil	4	nil
>1001	0.01% subject to min. 6 pieces	0.1% of pieces checked	4	nil

542 The following shall constitute acceptance tests for Anchor Assemblies:

- Visual \*
- Dimensional (as per SCD and overall dimensions submitted with Tender Offer)\*
- Mechanical Test on Bracket\*\*
- Mechanical Test on Clamp \*\*
- Voltage Test \*

543 The following shall constitute acceptance tests for Suspension Assemblies:

- Visual \*
- Dimensional (as per SCD and overall dimensions submitted with Tender Offer)\*
- Mechanical Test on Bracket\*\*
- Mechanical Test on Clamp \*\*
- Voltage Test \*

The above tests (for AA & SA) are to be carried out as per sampling plan below. In case of random failure/defect, double the sample lot is to be drawn and there should be no failure/defect exceeding half the permissible defects (rounded down) shown in the chart.

Lot Size	For tests Marked*		For tests Marked**	
	Sample Size	Max. permissible Defects	Sample Size	Max. permissible Defects
Upto 100	2	nil	1	nil
101 - 500	5	1	2	nil
501 - 2500	10	2	2	nil
2501 & above	10 + 0.2 %	2 + 10% pf addl. Sample quantity	4	1

**Annexure V: General Arrangement drawings.**

**1-ph Connections:**

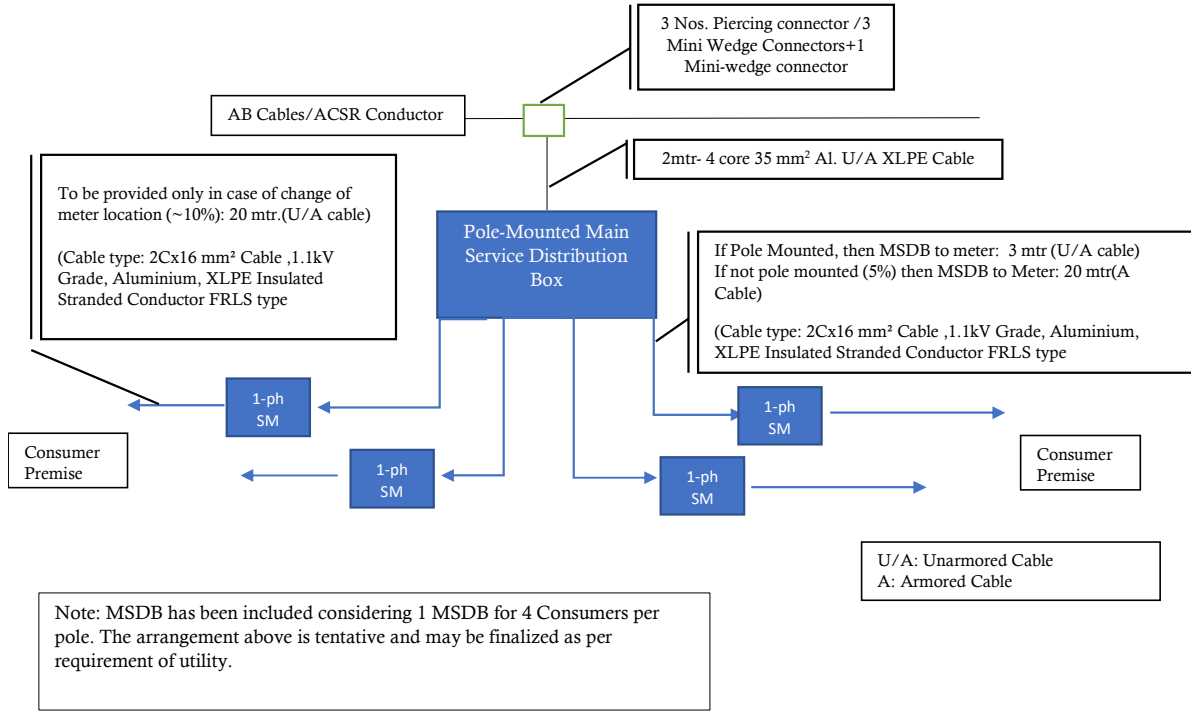

**3-ph Connections:**

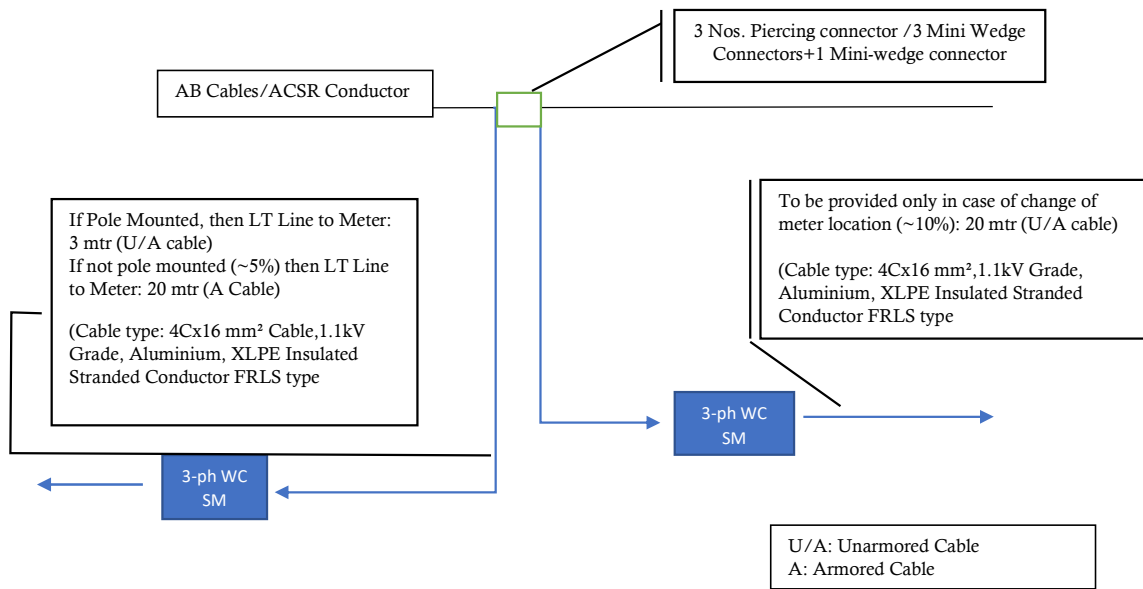

*Note: The above drawings are tentative and may be revised as per the requirement of the **MVVNL***

## PART II

### CONTRACT FORM AND CONDITIONS OF CONTRACT

#### Contract for

**Appointment of AMI Service Provider for Smart Prepaid Metering in Uttar Pradesh, India  
on DBFOOT basis**

#### Between

[STATE POWER **MVVNL**]

AND

[ SPV incorporated by Selected Bidder]<sup>1</sup>

AND

[ SELECTED BIDDER]

---

<sup>1</sup> Notes:

- (i) Applicable only in the event the **MVVNL** proposes to incorporate a Special Purpose Vehicle (SPV) by the Selected Bidder for project implementation.
- (ii) The provisions in square brackets and/or blank spaces shall be suitably filled post finalisation of the Contract.



## Section 7. Contract Form and Conditions of Contract

### TABLE OF CONTENTS

Article/ Clause.....	359
1. Definitions and Interpretations .....	359
2. The Contract .....	363
3. Obligations of the Selected Bidder in case an SPV has been formed.....	363
4. Rights, Title and Interest to AMI System and Equipment .....	364
5. Contract Price and Payment .....	365
6. Performance Security .....	368
7. Liquidated Damages, Penalty and Incentive .....	369
8. SLAs and SLA Audit .....	370
9. Force Majeure.....	370
10. Intellectual Property .....	374
11. Termination .....	375
12. Liability/ Indemnity .....	384
13. Governing Laws and Settlement of Disputes.....	387
14. Change Order .....	388
15. Miscellaneous.....	392
16. Confidential Information.....	393
17. Subcontracting.....	395
18. Warranty.....	395
19. Change in Laws and Regulations .....	396
20. Severability.....	396
21. Language .....	397
22. Assignment.....	397
23. Entire Agreement.....	397
24. Disclaimer .....	397
25. Public Disclosure .....	398
26. Adherence to Safety Procedures, Rules, Regulations and Restriction .....	398
27. Non- Solicitation of Staff.....	398
28. Survival .....	399
29. Notices .....	399
III. Special Conditions of Contract .....	402

## A. Form of Contract

*(Applicable in the event SPV incorporated by Selected Bidder)*

THIS Contract (hereinafter referred to as “**Contract**”) executed on this ..... [date] day of ..... [month], ..... [year]:

**BETWEEN:**

[Insert name of the **MVVNL**] (hereinafter referred to as “**MVVNL**” which expression shall unless repugnant to the context or meaning thereof include its successors, assigns and permitted substitutes), a company incorporated under the extant provisions of Indian Laws and having its registered office at [Address];

**AND**

..... <insert the name of the SPV>, a company incorporated in terms of the Companies Act, 2013 having its registered office at..... [Registered address of the Company] (hereinafter referred to as the “**AMISP**” which expression shall unless repugnant to the context or meaning thereof include its successors, assigns and permitted substitutes).

**AND**

*< insert the following if the Selected Bidder identified pursuant to the RFP is Sole Bidder >*

....., < insert the name of Selected Bidder > having its registered office at..... [Registered address of the Company] (hereinafter referred to as the “**Selected Bidder**” which expression shall unless repugnant to the context or meaning thereof include its successors, assigns and permitted substitutes).

*< insert the following in case the Selected Bidder identified pursuant to the RFP is a Consortium >*

..... < insert the name of the Lead Member of the Consortium who is the Selected Bidder >, having its registered office at..... [Registered address of the Company], the Lead Member acting for and on behalf of the Consortium comprising .....<insert name of the all the members of the Consortium including the Lead Member> (hereinafter referred to as the “**Selected Bidder**” which expression shall unless repugnant to the context or meaning thereof include its/ their successors, assigns and permitted substitutes).

**WHEREAS** the **MVVNL** had invited Bids for Appointment of AMI Service Provider for Smart Prepaid Metering in U. P., India on Design Build Finance Own Operate Transfer (DBFOOT) basis (the “Project”) through RFP/Tender No. [Tender Details]

**WHEAREAS** after evaluation of the Bids received from the Bidders, the **MVVNL** accepted the Bid of the Selected Bidder, and issued its Letter of Award No. [ ] dated [ ] (“**LOA**”) to the Selected Bidder **by the MVVNL**, requiring the Selected Bidder, inter alia, to execute this Contract within the time period prescribed in the RFP.

**WHEAREAS** the Selected Bidder has since promoted and incorporated such a special purpose vehicle as the AMISP under the Companies Act, 2013 in accordance with the terms of the RFP, and has requested the **MVVNL** to accept the AMISP as the entity which shall undertake and perform the



obligations and exercise the rights of the Selected Bidder under the LOA, including the obligation to enter into this Contract for Design Build Finance Own Operate Transfer (DBFOOT) AMI system in the Project area.

**WHEAREAS** the AMISP, by its letter dated [\_\_\_\_\_], while representing that it has been promoted by the Selected Bidder for the purposes hereof, joined in the request of the Selected Bidder to the **MVVNL** to accept the AMISP as the entity which shall undertake and perform the obligations and exercise the rights of the Selected Bidder including the obligation to enter into this Contract pursuant to the Letter of Award (LOA).

**NOW, THEREFORE**, in consideration of the foregoing and the respective covenants and agreements set forth in this Contract, the receipt and sufficiency of which is hereby acknowledged, and intending to be legally bound hereby, the Parties agree as follows:

- 1. The following documents attached hereto shall be deemed to form an integral part of this Contract:
  - (a) The General Conditions of Contract (including Attachment 1 “Fraud and Corruption”;
  - (b) The Special Conditions of Contract;
  - (c) Appendices:
    - Appendix A: Project Requirements (AMI System Requirements and Service Level Agreement)
    - Appendix B: AMISP Service Charge
  - (d) Technical and Financial Bid as submitted by the Selected Bidder

In the event of any inconsistency between the documents, the following order of precedence shall prevail: the Special Conditions of Contract; the General Conditions of Contract, including amendments thereto [... *Insert reference to amendments*...]; Appendix A and Appendix B; and Technical and Financial Bid as submitted by the Selected Bidder. Any reference to this Contract shall include, where the context permits, a reference to its Appendices also.

**IN WITNESS WHEREOF**, the AMISP, the Selected Bidder and the **MVVNL**, executed these presents and affixed common seals of their respective companies on the Day, Month and Year first mentioned above.

- 1. Common Seal of **MVVNL** has been affixed in my/ our presence pursuant to Board Resolution dated .....
- For **MVVNL**

[Signature of Authorized Representative]

.....  
[Name of the Authorized Representative]  
[Designation of the Authorized Representative]

1. Common Seal of ..... [Name of the Lead Consortium Member/ Sole Bidder], has been affixed in my/ our presence pursuant to Board Resolution dated .....  
For [Selected Bidder]

[Name of the Lead Consortium Member/ Sole Bidder],  
[Signature of Authorized Representative]

.....  
[Name of the Authorized Representative]  
[Designation of the Authorized Representative]

2. Common Seal of ..... [Name of the AMISP], has been affixed in my/ our presence pursuant to Board Resolution dated .....  
For AMISP

[Name of the AMISP],  
[Signature of Authorized Representative]

.....  
[Name of the Authorized Representative]  
[Designation of the Authorized Representative]

**WITNESS:**

1. .... (Signature) Name  
.....  
Designation.....

2. .... (Signature) Name  
.....  
Designation.....

**Attested:**

.....  
[Signature]  
(Notary Public)

Place: .....

Date: .....

## B. Form of Contract

*(Applicable in the event SPV is not incorporated in the case, when CPSE / PSU or a Subsidiary/ Joint Venture of a CPSE/ PSU is the sole bidder/ lead consortium member)*

THIS Contract (hereinafter referred to as “**Contract**”) executed on this ..... [date] day of ..... [month], ..... [year]:

### BETWEEN

[Insert name of the **MVVNL**] (hereinafter referred to as “**MVVNL**” which expression shall unless repugnant to the context or meaning thereof include its successors, assigns and permitted substitutes), a company incorporated under the extant provisions of Indian Laws and having its registered office at [Address];

### AND

..... , < insert the name of Selected Bidder, being the Sole Bidder/ lead consortium member> having its registered office at..... [Registered address of the Company] (hereinafter referred to as the “**AMISP**” which expression shall unless repugnant to the context or meaning thereof include its successors, assigns and permitted substitutes).

**WHEREAS** the **MVVNL** had invited Bids for Appointment of AMI Service Provider for Smart Prepaid Metering in India on Design Build Finance Own Operate Transfer (DBFOOT) basis (the “Project”) through RFP/Tender No. [Tender Details]

**WHEAREAS** after evaluation of the Bids received from the Bidders, the **MVVNL** accepted the Bid of the AMISP, and issued its Letter of Award No. [ ] dated [ ] (“**LOA**”) to the Selected Bidder, requiring the Selected Bidder, inter alia, to execute this Contract within the time period prescribed in the RFP.

**WHEAREAS** the AMISP, in accordance with the terms of the RFP, shall undertake and perform the obligations and exercise the rights under the LOA, including the obligation to enter into this Contract for Design Build Finance Own Operate Transfer (DBFOOT) AMI system in the Project area.

**NOW, THEREFORE**, in consideration of the foregoing and the respective covenants and agreements set forth in this Contract, the receipt and sufficiency of which is hereby acknowledged, and intending to be legally bound hereby, the Parties agree as follows:

1. The following documents attached hereto shall be deemed to form an integral part of this Contract:
  - (a) The General Conditions of Contract (including Attachment 1 “Fraud and Corruption”;
  - (b) The Special Conditions of Contract;

(c) Appendices:

Appendix A: Project Requirements (AMI System Requirements and Service Level Agreement)

Appendix B: AMISP Service Charge

(d) Technical and Financial Bid as submitted by the Selected Bidder

In the event of any inconsistency between the documents, the following order of precedence shall prevail: the Special Conditions of Contract; the General Conditions of Contract, including amendments thereto [... *Insert reference to amendments*...]; Appendix A and Appendix B; and Technical and Financial Bid as submitted by the Selected Bidder. Any reference to this Contract shall include, where the context permits, a reference to its Appendices also.

**IN WITNESS WHEREOF**, the AMISP and the **MVVNL**, executed these presents and affixed common seals of their respective companies on the Day, Month and Year first mentioned above.

1. Common Seal of **MVVNL** has been affixed in my/ our presence pursuant to Board Resolution dated .....  
For **MVVNL**

[Signature of Authorized Representative]

.....  
[Name of the Authorized Representative]  
[Designation of the Authorized Representative]

3. Common Seal of ..... [Name of the Sole Bidder/AMISP], has been affixed in my/ our presence pursuant to Board Resolution dated .....  
For [Sole Bidder/ AMISP]

[Name of the AMISP/ Sole Bidder],  
[Signature of Authorized Representative]

.....  
[Name of the Authorized Representative]  
[Designation of the Authorized Representative]

**WITNESS:**

3. .... (Signature) Name  
.....  
Designation.....

4. .... (Signature) Name  
.....  
Designation.....

**Attested:**

.....  
[Signature]  
(Notary Public)

Place: .....

Date: .....



## II. General Conditions of Contract

### Article/ Clause

#### 1. Definitions and Interpretations

##### (a) Definitions

1.1 In this Contract, unless the context otherwise requires, the following words, expressions and abbreviations shall have the following meanings:

- (a) **“Advanced Metering Infrastructure” or “AMI”** means an integrated system of Smart Meters, communication networks and meter data management systems that enables two-way communication between the utilities and consumer premises equipment. The functional blocks of AMI typically include HES — Head End System, WAN — Wide Area Network, NAN — Neighbourhood Area Network, DCU — Data Concentrator Unit / Gateway and HAN — Home Area Network;
- (b) **“Advanced Metering Infrastructure Service Provider” or “AMISP”**, means the responsible implementation agency named in SCC appointed by **MVVNL** for designing, building, financing, owning, operating and transferring the AMI Project in its area of operation upon execution of the Contract subsequent to the Letter of Award referred to in SCC;
- (c) **“Affected Party”** means any of the AMISP or the **MVVNL** whose performance has been affected by an event of Force Majeure or Force Majeure Event;
- (d) **“AMISP Service Charge”** means the payment to be made by the **MVVNL** to the AMISP in Indian Rupee (INR) per meter per month for each category of meter as indicated in **Appendix B**;
- (e) **“Applicable Laws”** shall mean the laws and any other instruments having the force of law in India as they may be issued and in force from time to time;
- (f) **“Bid”** means the bid submitted by the Bidder(s) in response to the RFP and shall include the Technical Bid and the Financial Bid;
- (g) **“Bidder(s)”** means individual entity or consortium of entities bidding in response to the RFP;
- (h) **“Change Order”** shall have the meaning as ascribed

thereto in Article 14 of this Contract;

- (i) **“Consortium Member”** Any member of the bidding consortium other than the Lead Consortium Member;
- (j) **“AMISP Contract” or “Contract”** shall mean this Contract entered into between, the SPV incorporated by the Selected Bidder (if applicable and so indicated in **SCC**), Selected Bidder (represented by the Lead Member acting for and on behalf of the consortium if the Selected Bidder is a consortium) and the **MVVNL** for undertaking the AMI Project and is the legally binding written agreement signed by the Parties and which includes all the attached documents listed in its paragraph 1 of the Form of Contract (the General Conditions (GCC), the Special Conditions (SCC), and the Appendices, Attachments, Annexures etc.).
- (k) **“Contract Period” or “Term of the Contract”** shall have the meaning as ascribed thereto in Article 2.1.2 of this Contract;
- (l) **“Contract Price”** shall have the meaning as ascribed thereto in Article 5.1 of this Contract;
- (m) **“Day”** means a calendar day unless indicated otherwise;
- (n) **“Exit Management Period”** shall mean the transition period encompassing the time from the date of termination of the Contract or end of the Contract Period until the date upon which all transition activities/ services are completed by the AMISP;
- (o) **“Force Majeure” or “Force Majeure Event”** shall have the meaning as ascribed thereto in Article 9 of this Section;
- (p) **“GCC”** means these General Conditions of Contract.
- (q) **“Goods”** means any good(s) supplied or to be supplied as a part of the Solution by the AMISP;
- (r) **“Independent Valuer”** shall mean a qualified valuer duly registered under Companies (Registered Valuers and Valuation) Rules, 2017 for Plant and Machinery and jointly appointed by the Parties in the event of termination prior to Installation Milestone;
- (s) **“Lender”** means the banks, financial institutions, multilateral funding agencies, non-banking financial companies registered with the Reserve Bank of India (RBI), insurance companies registered with the Insurance Regulatory & Development Authority (IRDA), pension funds regulated by the Pension Fund Regulatory & Development Authority (PFRDA), mutual funds registered with Securities & Exchange Board of India (SEBI), etc., including their successors and assigns, who have agreed to provide the AMISP with the debt



financing, and any successor banks or financial institutions to whom their interests may be transferred or assigned;

- (t) **“Month”** means a calendar month unless indicated otherwise;
- (u) **“Operational Go Live”** shall have the meaning ascribed thereto in Clause 9.6 of Section 6;
- (v) **“Operational Period”** means the period from the Operational Go-Live till the end of the Contract Period;
- (w) **“Project or AMI Project”** means the **MVVNL**'s AMI Project defined in recital clause in the Contract Form;
- (x) **“Project Implementation Schedule”** shall have the meaning ascribed thereto in Clause 12 of Section 6;
- (y) **“Request for Proposal” or “RFP”** means the Tender of which the number, name and details have been mentioned in SCC, including all its Volumes/ Sections/ Forms/ Annexures/ Appendices etc., for Appointment of AMISP (including all clarification/ addendum/ amendment/ corrigendum/ etc. issued from time to time);
- (z) **“Rupees” or “Rs.” Or “INR” or “₹”** means Indian Rupees;
- (aa) **“SCC”** means the Special Conditions of Contract by which the GCC may be amended or supplemented.
- (bb) **“Service(s)” or “Related Service(s)”** means any service(s) performed or to be performed as a part of the Solution by the AMISP;
- (cc) **SLA Default Notice means** notice to be issued by the **MVVNL** in the event AMISP fails meet any of the criteria specified in the SLA for cumulatively 3 (three) months in past 6 (six) months so as to entitling levy of maximum penalty for such criteria;
- (dd) **“Smart Meter”** shall mean and is an ac static watt-hour meter with time of use registers, internal connect and disconnect switches with two-way communication capability. It is designed to measure flow of forward (import) or both forward (import) and reverse (export), store and communicate the same along with other parameters defined in this standard. It shall be remotely accessed for collecting data/events, programming for select parameters *(as defined in IS 16444 including any amendments or modifications to the same from time to time)*;
- (ee) **“Solution”** shall mean the AMI system implemented in its entirety including but not limited to the designing, financing, supply of hardware, software, transportation, installation, integration, testing, commissioning,

operation, maintenance, training and other services by the AMISP;

- (ff) **“Termination Payment”** shall have the meaning as ascribed thereto in Article 11 of GCC in Section 7;
- (gg) **“MVVNL”** shall have the same meaning as ascribed to it in the recital clause of the Form of Contract and also to refer to MVVNL which has issued Letter of Award.
- (hh) **“Meter-months”**: At any point of time, meter-months of the AMI system is calculated as the sum of number of months from operationalization of the meter or Operational Go-Live, whichever is later, for all meters installed and commissioned by the AMISP, taking into account all Change Orders issued by the **MVVNL**
- (ii) **“Total Meter-months”**: Total Meter-months of the AMI system is calculated as the product of total number of smart meters installed, integrated and operationalized in the Project (by taking into account all Change Orders issued by the **MVVNL**) and 90 (ninety) months commencing from Operational Go-Live
- (jj) **“Installation Milestone”** shall have the meaning as ascribed thereto in Clause 12 of Section 6;

## (b) Interpretation

- 1.2 In the interpretation of this Contract, unless the context otherwise requires:
  - 1.2.1. **MVVNL**, the Selected Bidder, and the AMISP/ Contractor shall individually be referred to as “Party” and collectively as “Parties”;
  - 1.2.2. Unless otherwise specified a reference to an Article number is a reference to all of its sub-articles;
  - 1.2.3. Unless otherwise specified a reference to a clause, sub-clause or section is a reference to a clause, sub-clause or section of this Contract including any amendments or modifications to the same from time to time;
  - 1.2.4. A word in the singular includes the plural and a word in the plural includes the singular;
  - 1.2.5. A word importing a gender includes any other gender;
  - 1.2.6. A reference to a person includes a partnership and a body corporate;
  - 1.2.7. A reference to legislation includes legislation repealing, replacing or amending that legislation;

- 1.2.8. Where a word or phrase is given a particular meaning, it includes the appropriate grammatical forms of that word or phrase which has a corresponding meaning;
- 1.2.9. In the event of an inconsistency between the terms of the RFP, Bid submitted by the Selected Bidder and the subsequent Contract, the terms of the Contract hereof shall prevail;
- 1.2.10. Whenever a material or article is specified or described by the name of a particular brand, manufacturer or trademark, the specific item shall be understood as establishing type, function and quality desired. Products of other manufacturers may also be considered, provided sufficient information is furnished so as to enable **MVVNL** to determine that the products are equivalent to those named.
- 1.2.11. No amendment or other variation of this Contract shall be valid unless it is in writing, is dated, expressly refers to this Contract, and is signed by a duly authorised representative of both **MVVNL** and the AMISP thereto.
- 1.2.12. An illustration of the methodology for determining the 'Total Meter-Months' as well as 'Operation and Maintenance Period of the AMI system' is provided in **SCC**.

## **2. The Contract**

### **(a) Effectiveness and Term**

#### **2.1. EFFECTIVENESS AND TERM**

- 2.1.1. This Contract shall come into force and effect on the date of execution of the Contract by the Parties;
- 2.1.2. Unless terminated earlier by either Party or extended by the **MVVNL** in accordance with the terms of this Contract, this Contract shall continue in full force and effect until the earlier of (a) 10 (ten) years from the date of execution of the Contract or (b) As soon as the "Meter-Months" exceeds "Total Meter-months" ("Term of the Contract").
- 2.1.3. The **MVVNL**, at its own discretion, may extend the operation and maintenance period of the AMI system at terms mutually agreed upon with the AMISP.

### **3. Obligations of the Selected**

- 3.1 In case an SPV has been formed, Selected Bidder shall ensure that it along with other members of the Consortium,

**Bidder in case an SPV has been formed**

if any, subscribe to 100% (one hundred percent) of the equity share capital of the SPV and continue to hold such shares for a period up to two years after Installation Milestone. In the event Selected Bidder is a consortium then the shareholding pattern indicated in the Consortium Agreement, shall be maintained for a period up to two years after Installation Milestone.

- 3.2 In case a SPV has been formed, the Selected Bidder along with other members of the Consortium, if any, shall continue to hold not less than 51% (fifty-one percent) for the entire term of the AMISP Contract;
- 3.3 In the event the Selected Bidder is a Consortium, the Lead Consortium Member shall hold at least 51% (fifty-one per cent) of the equity of the AMISP at all times until the expiry of two years from the Installation Milestone as per this Contract and 26% (twenty-six) for the remaining term of this Contract.
- 3.4 Subject to the conditions of the contract, any direct and/ or indirect change in shareholding of SPV, if formed, shall require prior approval of the **MVVNL**. Any change in shareholding shall be in compliance with applicable laws including but not limited to the guidelines issued vide Order No. F/No.6/18/2019-PPD by Ministry of Finance, Department of Expenditure, Public Procurement Division dated 23 July 2020 and rules for foreign direct investment in India.

**4. Rights, Title and Interest to AMI System and Equipment**

- 4.1 The ownership, rights and title to the AMI system and other equipment installed by AMISP for operation of the AMI system pursuant to this Contract shall vest with AMISP during the entire Term of Contract.

However, the lenders shall have first right on AMISP's assets subject to the fulfilment of the provisions in this Contract.

- 4.2 Unless extended by mutual consent of the **MVVNL** and AMISP, after the Contract Period the ownership, rights and title of the installed AMI system and other equipment (if any) installed by AMISP for operation of the AMI system pursuant to this Contract shall be transferred to the

**MVVNL** without any cost.

## 5. Contract Price and Payment

### (a) Contract Price

#### 5.1 CONTRACT PRICE

5.1.1 The Contract Price is as indicated in **SCC**

5.1.2 In the event any approval required for imports and/ or use of imported equipment is denied in accordance with all applicable laws including those in relation to testing issued by Ministry of Power (Order No No.9/16/2016-Trans-Part(2) dated 18 November 2020, as amended and/ or modified from time to time), the same shall neither entitle revision of Contract Price nor shall result in revision of the Project Implementation Plan as specified in Article 2.2 of this Contract.

### (b) Payment Mechanism

#### 5.2 PAYMENT MECHANISM

5.2.1 The payment shall be made to the AMISP in Indian Rupees (INR) only.

5.2.2 The payment to the AMISP shall commence only one month after Operational Go-Live as defined in Section 6;

5.2.3 The payments due to the AMISP from the MVVNL shall be paid on monthly basis as per the payment structure specified in **SCC**.

5.2.4 Except in case of Change Order in accordance with Article 14 of this Contract, the sum total of all payments made to the AMISP shall not exceed the Contract Price quoted in Article 5.1.1

5.2.5 The actual payment shall be net of any applicable liquidated damages and/or penalty due to noncompliance of SLAs by the AMISP.

5.2.6 (a) AMISP will issue separate invoices for Smart Pre-paid Metering works (Smart Metering) and LT Auxiliary Components (Meant for Supply and Installation of Armoured cable).

(b) AMISP will raise and deliver the invoice and the Deliverables mentioned above to the utility for the monthly

payments within first 3 (three) working days of every month. AMISP shall also raise a supplementary invoice for the agreed amount towards software change requests/new requirements completed in the previous month, in accordance with Article 14.2 of this Contract. **MVVNL** will review the AMISP invoice raised by the AMISP and the Deliverables including the SLA performance report, in accordance with Article 8, within 5 (five) working days from the invoice and SLA performance report delivered by the AMISP. **MVVNL** may dispute the amount payable and shall pay the undisputed amount of the payment due via **Escrow Account Mechanism** (as specified in Article 5.2.7). The disputed amount, (related to actual number of meters installed, integrated and operationalized, penalty imposed due to non-compliance of SLAs, and liquidated damages), shall be dealt as per Article 13 of this Contract

#### 5.2.7 **Payment mechanism for Smart Pre-Paid Metering Works**

**MVVNL** will open a separate collection account in a scheduled Bank for collection of recharge/payment made by such consumers where prepaid smart meters have been installed.

**MVVNL** will also open an **escrow account** in the same Bank and branch where from the date of receipt of recharge and online payment by such consumers a daily average revenue will be transferred to this escrow account to ensure that 1.25 time of average billing amount of last 3 months is fulfilled by 5th of the following month. In case of any fall/difference from the bills raised by the AMISP by 3rd of every month the same difference is to be either fulfilled or withdrawn latest by 10th of the same month as the case may be so that such escrow built up is not less than the billed amount and the payment will be released on 11th of every month or the next banking day.

#### 5.2.8 **Payment mechanism for LT Auxiliary Components (Armoured Cable Works).**

Payment of armoured service cable will be done after go-live of smart meter.

Separate invoice will be submitted for armoured service cable works along with details of consumer ID, length of armoured cable and smart meter number etc. on monthly basis after Go-live of smart meter.

**First Installment (90%):** Ninety percent (90%) payment against Supply & Erection shall be done on supply and

erection of armoured cable.

**Second and Final Installment (10%):** The balance ten percent (10%) of payment against supply & Erection shall be released on successful completion of the project upon issuance of Completion Certificate of the project.

5.2.9

<DELETED>

5.2.10 In the event the AMISP fails to meet a particular performance criterion as mentioned under the Service Level Agreement (SLA) specified in Clause 7.7 of **Section 6** for cumulatively 3 (three) months in past 6 (six) months, resulting in the maximum penalty for the particular performance criterion, **MVVNL** may issue an SLA Default Notice to the AMISP directing it to take steps within 90 days to comply with the performance criterion specified in the SLA<sup>1</sup>.

5.2.11 In the event a Smart Meter supplied and installed by the AMISP is damaged for reasons not attributable to the AMISP such as theft, vandalism, burning, etc. or as a result of Force Majeure Event, the AMISP shall not be liable for such damage. In such cases, upon receipt of Notice from the **MVVNL**, the AMISP shall repair or replace the damaged Smart Meters. AMISP shall be required to replace the Smart Meter no later than 15 days of notification by the **MVVNL**. Upon replacing the Smart Meter, AMISP shall be entitled to raise a supplementary invoice for the amount mutually agreed between AMISP and the **MVVNL**. The Supplementary Bill shall be paid along with the amount due to be paid towards AMISP Service Charges, for the immediately succeeding month. For the avoidance of doubt: (i) a damaged meter(s) shall be excluded from the total numbers installed and operational smart meters while conducting the SLA audit of the AMI system in accordance with Article 8; and (ii) in the event, AMISP replaces the Meter within 15 days of request by the **MVVNL** or **MVVNL** directs to continue operations without replacing the damaged Meter, the AMISP Service Charge *qua* such meter(s) shall be paid as if such damaged meter complies with the SLA prescribed in this AMISP Contract.

5.2.12. All payments under this AMISP Contract shall be made to the Lead Consortium Member and **MVVNL** shall have no

---

<sup>1</sup> For example, in the event AMISP fails to meet the norm specified for “**Availability of AMI System per month**” for cumulatively 3 (three) months in past 6 (six) months leading to levy of maximum penalty thereof.

role in inter se payments to the Consortium Members.

5.2.14. Payment to the AMISP by the **MVVNL** will be considered as an Operational Expenditure on **MVVNL**'s account

### 5.3 TAXES AND DUTIES

5.3.1 For Goods whether supplied from or outside India, the AMISP shall be entirely responsible for all taxes, duties, stamp duties, license fees, and other such levies imposed outside India.

5.3.2 Any statutory increase or decrease in the taxes and duties including GST and Cess as applicable or in the event of introduction of new tax/cess or cessation of existing tax/cess subsequent to the AMISP's offer on the goods and services explicitly mentioned in financial bid shall be dealt with in accordance with provisions of Change in Law.

**(c) Taxes and Duties**

5.3.3 Notwithstanding anything above or elsewhere in the Contract, in the event that the input tax credit of the GST charged by the AMISP is denied by the tax authorities to the **MVVNL** for reasons attributable to the AMISP, the **MVVNL** shall be entitled to recover such amount from the AMISP by way of adjustment from any of the subsequent invoices submitted by the AMISP to the **MVVNL**.

### 6. Performance Security

6.1 The AMISP has furnished Performance Security in the form of an irrevocable bank guarantee valid up to a period of 6 (six) months beyond the end of the Contract Period or extended thereafter, for the amount indicated in **SCC** on the prescribed format. However, in case of delay in Installation Milestone, the validity of the initial Performance Security shall be extended by the period of such delay. In the event delay is solely due to acts and/ or omission of the **MVVNL** cost of extending the validity of Performance Security shall be reimbursed to the AMISP by the **MVVNL**.

6.2 Upon achievement of Installation Milestone, the value of the Performance Security shall be reduced by AMISP, to the extent indicated in **SCC** as determined in accordance with numbers of meters considered for Installation Milestone.

6.3 Any payments shall be made to the AMISP only after receipt of the initial Performance Security by **MVVNL**.



6.4 Upon Termination of the Contract due to **MVVNL** Event of default or expiry of the Contract Period, the separate Performance Security shall be discharged by **MVVNL** without any interest and returned to the AMISP not later than 14 (fourteen) working days following the date of Termination of the Contract.

Upon Termination of the Contract due to AMISP Event of default, the Performance Security shall be forfeited by **MVVNL**.

6.5 In case of any delay by the AMISP in performing the activities of the scope of work with respect to the Project Implementation Schedule, then upon **MVVNL**'s request, the AMISP shall extend the validity of the separate Performance Security for the period for which the Contract is extended. In the event delay is solely due to acts and/ or omission of the **MVVNL** cost of extending the validity of separate Performance Security shall be reimbursed to the AMISP by the **MVVNL**.

## **7. Liquidated Damages, Penalty and Incentive**

7.1 Except in case of Force Majeure or where the delay in delivery of the Solution is caused due to any delay or default of **MVVNL**, if the Installation Milestone is delayed by more than 30 (thirty) months from the date of execution of the Contract the AMISP shall be liable to pay liquidated damages as per the rates specified in this Article.

7.2 Except in case of Force Majeure or where the delay in delivery of the Solution is caused due to any delay or default of **MVVNL**, if the delivery, site installation, integration and operationalization of:

7.2.1 100% of Feeder Meters each with related hardware, software and equipment is delayed by more than 9 (nine) months from the date of execution of the Contract the AMISP shall be liable to pay liquidated damages as per the rates specified in this Article.

7.2.2 100% of DT Meters each with related hardware, software and equipment is delayed by more than 18 (eighteen) months from the date of execution of the Contract the AMISP shall be liable to pay liquidated damages as per the rates specified in this Article.

7.3 **MVVNL** shall without prejudice to all its other remedies

under the Contract, deduct from the amount due to be paid, as liquidated damages, 50% of AMISP Service Charge for each delayed meter for each completed month of delay for a maximum period of 12 (twelve) months. An illustrative example for arriving at the deductions is given in **SCC**.

7.4 If the AMISP achieves milestone of “Installation Milestone (as provided in Section 6) at least one month in advance than the timelines specified in the Contract, **MVVNL** shall provide an incentive as specified in **SCC**.

7.5 Upon achieving Installation Milestone, in accordance with Article 7.4, AMISP shall be entitled to raise a supplementary invoice for the amount indicated therein. The Supplementary invoice shall be paid along with the amount due to be paid for AMISP Service Charges for the immediately succeeding month.

## 8. SLAs and SLA Audit

8.1 The AMISP shall be liable to penalties in the event of non-compliance of Service Level Agreements as specified in Section 6;

8.2 A designated team/ person from **MVVNL**/MVVNL may review the system generated SLA performance report of AMISP each month. The review/ audit report will form basis of any action relating to imposing penalty on or breach of Contract of the AMISP.

8.3 In case, there is no review/ audit report submitted within 10 (ten) working days of every month, it shall be deemed that all SLAs were met in the previous month.

## 9. Force Majeure (a) Force Majeure Event

9.1 A Force Majeure means any event or circumstance or combination of events and circumstances including those stated below that wholly or partly prevents or unavoidably delays an Affected Party in the performance of its obligations under this AMISP Contract, but only if and to the extent that such events or circumstances are not within the reasonable control, directly or indirectly, of the Affected Party and could not have been avoided if the Affected Party had taken reasonable care or complied with prudent **MVVNL** practices:

### a) Natural Force Majeure Events:

act of God, including, but not limited to drought, fire and explosion (to the extent originating from a source

external to the site), earthquake, epidemic, volcanic eruption, landslide, flood, cyclone, typhoon, tornado, or exceptionally adverse weather conditions,

**b) Non-Natural Force Majeure Events:**

**i) Direct Non-Natural Force Majeure Events**

- a) Nationalization or compulsory acquisition by any Governmental instrumentality of any material assets or rights of the AMISP; or
- b) the unlawful, unreasonable or discriminatory revocation of, or refusal to renew, any Consents, Clearances and Permits required by the AMISP to perform their obligations under the Contract or any unlawful, unreasonable or discriminatory refusal to grant any other Consents, Clearances and permits required for the development/ operation of the Project, provided that a Competent Court of Law declares the revocation or refusal to be unlawful, unreasonable and discriminatory and strikes the same down; or
- c) any other unlawful, unreasonable or discriminatory action on the part of any Governmental instrumentality which is directed against the Project, provided that a competent Court of law declares the action to be unlawful, unreasonable and discriminatory and strikes the same down.
- d) any partial or complete shut-down of the internet services in the Project area
- e) Shortage of labor, materials or utilities where caused by circumstances that are themselves Force Majeure
- f) Restrictions imposed by central or state government that prevent or delay project execution

**ii) Indirect Non - Natural Force Majeure Events:**

- a) an act of war (whether declared or undeclared), invasion, armed conflict or act of foreign enemy, blockade, embargo, riot, insurrection, terrorist or military action, civil commotion or politically motivated sabotage;

- b) radioactive contamination or ionizing radiation originating from a source in India or resulting from any other Indirect Non-Natural Force Majeure Event mentioned above, excluding circumstances where the source or cause of contamination or radiation is brought or has been brought into or near the Site by the Affected Party or those employed or engaged by the Affected Party; or
- c) industry wide strikes and labor disturbances, having a nationwide impact in India.

## 9.2 FORCE MAJEURE EXCLUSIONS

### (b) Force Majeure Exclusions

9.2.1 Force Majeure shall not include (i) any event or circumstance which is within the reasonable control of the Parties and (ii) the following conditions, except to the extent that they are consequences of an event of Force Majeure:

- i. Unavailability, late delivery, or changes in cost of the machinery, equipment, materials, spare parts etc. for the Project;
- ii. Delay in the performance of any Contractors or their agents;
- iii. Non-performance resulting from normal wear and tear typically experienced in transmission materials and equipment;
- iv. Strikes or labour disturbance at the facilities of the Affected Party;
- v. Insufficiency of finances or funds or the AMISP Contract becoming onerous to perform; and
- vi. Non-performance caused by, or connected with, the Affected Party's:
  - a. negligent or intentional acts, errors or omissions;
  - b. failure to comply with an Indian Law; or
  - c. breach of, or default under this AMISP Contract or any Project documents.

## 9.3 NOTIFICATION OF FORCE MAJEURE EVENT

### (c) Notification of Force Majeure Event

9.3.1 The Affected Party shall give notice to the other Party of any event of Force Majeure as soon as reasonably practicable, but not later than 7 (seven) days after the date on which such Party knew or should reasonably have known of the commencement of the event of Force Majeure. If an event of Force Majeure results in a

breakdown of communications rendering it unreasonable to give notice within the applicable time limit specified herein, then the Party claiming Force Majeure shall give such notice as soon as reasonably practicable after reinstatement of communications, but not later than 1(one) day after such reinstatement. Provided that such notice shall be a pre-condition to the Affected Party's entitlement to claim relief under this AMISP Contract. Such notice shall include full particulars of the event of Force Majeure, its effects on the Party claiming relief and the remedial measures proposed. The Affected Party shall give the other Party regular reports on the progress of those remedial measures and such other information as the other Party may reasonably request about the Force Majeure.

- 9.3.2 The Affected Party shall give notice to the other Party of (i) the cessation of the relevant event of Force Majeure; and (ii) the cessation of the effects of such event of Force Majeure on the performance of its rights or obligations under this AMISP Contract, as soon as practicable after becoming aware of each of these cessations.

#### **9.4 DUTY TO PERFORM AND DUTY TO MITIGATE**

- 9.4.1 To the extent not prevented by a Force Majeure Event, the Affected Party shall continue to perform its obligations as provided in this AMISP Contract. The Affected Party shall use its reasonable efforts to mitigate the effect of any event of Force Majeure as soon as practicable.

#### **(d) Duty to Perform and Duty to Mitigate**

#### **9.5 AVAILABLE RELIEF FOR A FORCE MAJEURE EVENT**

- 9.5.1 Subject to this Article 9

#### **(e) Available Relief for a Force Majeure Event**

- a) no Party shall be in breach of its obligations pursuant to this AMISP Contract except to the extent that the performance of its obligations was prevented, hindered or delayed due to a Force Majeure Event;
- b) every Party shall be entitled to claim relief for a Force Majeure Event affecting its performance in relation to its obligations under this AMISP Contract;
- c) in the event on the 10<sup>th</sup> anniversary of the date of execution of this AMISP Contract, the AMISP has not operated the AMI system for 'Total Meter-Months' due to a Force Majeure Event(s) the **MVVNL** shall extend the term of this AMISP Contract by such duration as may enable the operation of AMI system for the 'Total Meter-Months';

- d) The AMISP shall be entitled to receive payment at rates to be mutually agreed between the **MVVNL** and the AMISP for the smart meters replaced or repaired due to an event of force majeure.

## 10. Intellectual Property

- 10.1 All Intellectual Property Rights in all material (including but not limited to all Source code, Object code, records, reports, designs, application configurations, data and written material, products, specifications, reports, drawings and other documents), which have been newly created and developed by the AMISP solely during the performance of Related Services and for the purposes of inter-alia use or sub-license of such services under this Contract, shall be the property of the AMISP. The AMISP undertakes to disclose all such material, which have been newly created and developed by the AMISP solely during the performance of Related Services and for the purposes of inter-alia use or sub-license of such services under this Contract, to the **MVVNL**. The AMISP hereby grants to **MVVNL** a perpetual, non-exclusive, non-transferable, irrevocable, royalty-free license to use all material disclosed to the **MVVNL** under the Contract. Nothing contained herein shall be construed as transferring ownership of any Intellectual Property Right from the AMISP to the **MVVNL**.
- 10.2 The AMISP shall ensure that while it uses any software, hardware, processes, document or material in the course of performing the Services, it does not infringe the Intellectual Property Rights of any person and the AMISP shall keep the **MVVNL** indemnified against all costs, expenses and liabilities howsoever, arising out any illegal or unauthorized use (piracy) or in connection with any claim or proceedings relating to any breach or violation of any permission/license terms or infringement of any Intellectual Property Rights by the AMISP or its personnel during the course of performance of the Related Services. In case of any infringement by the AMISP, the AMISP shall have sole control of the defence and all related settlement negotiations
- 10.3 Subject to Article 10, the AMISP shall retain exclusive ownership of all methods, concepts, algorithms, trade secrets, software documentation, other intellectual property or other information belonging to the AMISP that existed

before the date of execution of the Contract.

## 11. Termination

### (a) AMISP Event of Default

- 11.1.1 AMISP Event of Default means any of the following events arising out of any acts or omission of AMISP, its representative, sub-contracts, employees and which have not occurred solely as a result of any breach of this Contract by the **MVVNL** or due to Force Majeure, and where AMISP has failed to remedy these events within a period of 90 (ninety) days of issuance of a notice by **MVVNL** requiring AMISP to remedy such event.
- a) AMISP has failed to procure and arrange requisite finances for the implementation of the Project;
  - b) AMISP abandons the implementation of the Project or repudiates this Contract or otherwise takes any action, or evidences or conveys an intention not to be bound by the Contract;
  - c) AMISP, in the judgment of **MVVNL**/MVVNL has engaged in corrupt, fraudulent, collusive, or coercive practices, in competing for or in executing the Contract; or
  - d) AMISP is adjudged bankrupt or insolvent, or if a trustee or receiver is appointed for AMISP or for the whole or material part of its assets that has a material bearing on its ability to implement the Project;
  - e) AMISP has been, or is in the process of being liquidated, dissolved, wound-up, amalgamated or reconstituted in a manner that in the reasonable opinion of **MVVNL** would adversely affect AMISP's ability to implement the Project;
  - f) A resolution for winding up of AMISP is passed, or any petition for winding up of AMISP is admitted by a court of competent jurisdiction and a provisional liquidator or receiver is appointed and such order has not been set aside within 90 (Ninety) days of the date thereof or AMISP is ordered to be wound up by a court of competent jurisdiction;
  - g) In the event AMISP fails to cure the default as indicated in the SLA Default Notice within the time period specified therein;
  - h) Failure of AMISP to furnish Performance Security in accordance with the provisions of this Contract;
  - i) Failure or inordinate delay by AMISP to provide Solution as per Contract;
  - j) Any representation or warranty made by the AMISP during the term of the Contract is found to be false and/or

- misleading;
- k) Failure on account of AMISP to abide by Applicable Laws and regulations;
  - l) The shareholding of the AMISP ceases to be in accordance with the provisions of this Contract;
  - m) In the event equipment installed or proposed to be installed by the AMISP is found to have any embedded malware/ trojans/ cyber threat;
  - n) AMISP fails to comply with the local content requirement as specified in the Bid Submission;
  - o) AMISP fails to comply with any of its material obligations under this Contract.
  - p) In the event the Solution supplied do not meet the minimum specifications as per the Contract, and the same is not replaced/ modified by the AMISP to meet the requirements within 14 (fourteen) working days of being informed by **MVVNL**, or as mutually decided between **MVVNL** and AMISP.

11.2.1 **MVVNL** Event of Default means any of the following events, unless such event has occurred as a consequence of the AMISP Event of Default or a Force Majeure event and where **MVVNL** has failed to remedy these events within a period of 90 (ninety) days of issuance of a notice by AMISP requiring **MVVNL** to remedy such event:

**(b) **MVVNL** Event of Default**

- a) Failure of **MVVNL** to establish Direct Debit Facility through online Consumer payments or pay the Monthly amount due to be paid including amount due towards supplementary invoice in accordance with Article 5.2 or any other payment due from **MVVNL** under this Contract and more than 90 (ninety) days have elapsed since such payments became due;
- b) **MVVNL** is adjudged bankrupt or insolvent, or if a trustee or receiver is appointed for **MVVNL** or for the whole or material part of its assets that has a material bearing on its ability to perform its obligations under this Contract;
- c) **MVVNL** has been, or is in the process of being liquidated, dissolved, wound-up, amalgamated or reconstituted in a manner that in the reasonable opinion of AMISP would adversely affect **MVVNL**'s ability to perform its obligations under this Contract;
- d) A resolution for winding up of **MVVNL** is passed, or any petition for winding up of **MVVNL** is admitted by a court of competent jurisdiction and a provisional liquidator or receiver is appointed and such order has not been set aside



within [90 (Ninety)] days of the date thereof or **MVVNL** is ordered to be wound up by a court of competent jurisdiction;

- e) The breach by **MVVNL** of its obligations under this Contract which has an adverse effect on the performance of AMISP's obligations under this Contract.

### 11.3 TERMINATION FOR AMISP EVENT FOR DEFAULT

**(c) Termination for  
AMISP Event for  
Default**

11.3.1 Without prejudice to any other right or remedy which **MVVNL** may have in respect thereof under this Contract, upon the occurrence of AMISP Event of Default, **MVVNL** shall be entitled to terminate this Contract in the manner provided in Article 11.3.2.

11.3.2 **MVVNL** shall issue a Preliminary Notice to AMISP providing 90 (Ninety) Days, or such extended period as the **MVVNL** may allow, to cure the underlying Event of Default. If AMISP fails to cure the underlying Event of Default within such period allowed, **MVVNL** shall be entitled to terminate this Contract by issuing a termination notice to AMISP.

### 11.4 TERMINATION FOR MVVNL EVENT FOR DEFAULT

**(d) Termination for  
MVVNL Event of  
Default**

11.4.1 Without prejudice to any other right or remedy which AMISP may have in respect thereof under this Contract, upon the occurrence of a **MVVNL** Event of Default, AMISP shall be entitled to terminate this Contract in the manner provided in Article 11.4.2.

11.4.2 AMISP shall issue a Preliminary Notice to **MVVNL** providing 90 (Ninety) Days, or such extended period as the AMISP may allow, to cure the underlying Event of Default. If **MVVNL** fails to cure the underlying Event of Default within such period allowed, AMISP shall be entitled to terminate this Contract by issuing a termination notice to **MVVNL**.

### 11.5 CONSEQUENCES OF TERMINATION

Upon Termination of the Contract, the AMISP shall:

**(e) Consequences of  
Termination**

11.5.1 Notwithstanding anything to the contrary contained in this Contract, any termination of this Contract pursuant to its term shall be without prejudice to accrued rights of any Party, including its right to claim and recover damages and other rights and remedies which it may have in law or contract. All accrued rights and obligations of any of the

Parties under this Contract, shall survive the termination of this Contract to the extent such survival is necessary for giving effect to such rights and obligations.

11.5.2 Following issue of the Termination Notice by MVVNL or AMISP, MVVNL take possession and control of AMISP's control room and call centre and the exclusivity granted to AMISP under Article 4 will come to an end.

11.5.3 Upon termination of this Contract by MVVNL or AMISP on account of AMISP's Event of Default (in accordance with Article 11.1), or termination of this Contract on account of MVVNL's event of default (in accordance with Article 11.2), AMISP shall be entitled to a termination payment subject to proper transfer of the installed AMI System, as agreed mutually upon, basis the following criteria:

- a) In case termination of this Contract is on account of AMISP's event of default: Termination payment to AMISP after Installation Milestone has been declared shall be the percentage, specified in SCC, of the termination payment Value as determined in terms of this Contract.
- b) In case termination of this Contract is on account of MVVNL's event of default: Termination payment to AMISP after Installation Milestone has been declared shall be the percentage, specified in SCC, of the termination payment Value as determined in terms of this Contract.
- c) In case termination of this Contract is prior to Installation Milestone the Termination payment shall be equal to:
  - i. the percentage, specified in SCC, of the value of the assets proposed to be handed over to the MVVNL as certified by an independent valuer in the event termination is on account of AMISP event of default—and
  - ii. the percentage, specified in SCC, of the asset values shall be paid to the AMISP in the event termination is on account of MVVNL event of default

For the avoidance of doubt, it is clarified that in the event lumpsum payment in terms of Article 5 has been made then such payment shall be reduced from the amount determined in accordance with this Article 11.5.3.(c)

- d) In case termination of the Contract is prior to the Installation Milestone- The Goods that are complete and ready for shipment within 28 (twenty-eight) days after the AMISP's receipt of the Notice of termination shall be taken into account while determining value of the assets proposed to be handed over to the **MVVNL**.
- e) In the event of termination prior to Installation Milestone, MVVNL may request the AMISP to complete any part of the Solution. The cost of such works shall be agreed between the Parties. In the event Parties deem it appropriate the cost may be determined by the Independent Valuer.

Upon termination of this Contract by **MVVNL** or AMISP on account of AMISP's Event of Default (in accordance with Article 11.1), or termination of this Contract on account of **MVVNL**'s event of default (in accordance with Article 11.2), AMISP shall be entitled to raise a supplementary invoice for an amount which is equal to the termination payment. The Supplementary invoice shall be paid separately by the **MVVNL** within 30 (thirty) days from the date of such invoice.

11.5.4 The Termination payment value would be calculated basis the following mechanism:

- a) The present value of the receivables for the AMI system installed shall be calculated by multiplying the outstanding meter-months of operating the AMI system with percentage of total meters installed, integrated and operationalized as on the date of termination, and AMISP Service Charge, and discounting the same as on date of termination at the percentage specified in **SCC** (“**Present Value**”).
- b) All amounts due, but not paid by the **MVVNL**, including the aggregated amount due to be paid including amount due to be paid towards supplementary invoice, but not paid or recovered from the **MVVNL**, for the AMI system operations and maintenance as defined in the RFP by the AMISP, shall be calculated and factored in to arrive at the net outstanding receivables of the AMISP (“**Outstanding Receivables**”);
- c) All amounts due, but not paid by the AMISP, including the aggregated applicable liquidated damages and/(or) penalties due to non-compliance of SLAs by the AMISP, but not paid or recovered from the AMISP, for

the AMI system operations and maintenance as defined in the RFP by the AMISP, shall be calculated and factored in to arrive at the net outstanding payables by the AMISP (“**Outstanding Payables**”);

- d) Termination Payment Value shall be equal to the sum of Net Present Value and Outstanding Receivables as per Article 11.5.4.(a) and (b); reduced by Outstanding Payables as per Article 11.5.4.(c) and the sum of insurance proceeds received by the AMISP for the AMI system, (if any).

11.5.5 Upon Termination of the Contract or expiry of the contract period, the AMISP shall prepare and present a detailed Exit Management Plan within 5 (five) working days of termination notice receipt to the **MVVNL** (“**Exit Management Plan**”) in accordance with Article 11.6.

11.5.6 The **MVVNL** or its nominated agency will review the Exit Management plan. If approved, AMISP shall start working on the same immediately. If the plan is rejected, AMISP shall prepare alternate plan within 2 (two) working days. If the second plan is also rejected, **MVVNL** will provide a plan for AMISP and it should be adhered by in totality.

11.5.7 The Exit Management Plan should cover at least the following:

- a) Execute all documents that may be necessary to effectively transfer the ownership and title, including OEM warranties in respect of all equipment;
- b) Handover all developed codes, related documentation and other Configurable Items, if any in his possession;
- c) Handover the list of all IT Assets, passwords at all locations to **MVVNL**.

11.5.8 The AMISP and the Authorized personnel from **MVVNL** will sign a completion certificate at the end of successful completion (all points tracked to closure) of the Exit Management Plan.

## 11.6 Exit Management

### 11.6.1 Exit Management

#### (f) Exit Management

In case the Contract with the **MVVNL** ends or is terminated before the expiry date of Contracts, the Parties shall agree at that time whether, and if so during what period, the provisions of this Exit Management Plan shall

apply. The Parties shall ensure that their respective associated entities carry out their respective obligations set out in this Exit Management Plan. The exit management shall be done in such a manner that operations should continue without any restriction on access/usage of any kind of functionality. At the end of the Contract period, AMISP shall provide necessary handholding and transition support to the **MVVNL** or its agency for maintaining the system post the Contract with the AMISP. This includes (but not limited to):

- a) Conducting detailed walkthrough and demonstrations for the AMI Solution;
- b) Handing over of AMI Solution, **MVVNL**'s data and all other relevant documentation including updated detailed bill of quantities for materials and services provided under the Contract;
- c) Addressing the queries/clarifications of the designated staff / new agency with respect to the working / performance levels of the infrastructure;
- d) Conducting training sessions;
- e) Knowledge Transfer;
- f) Any other activity, over and above these, as may be deemed necessary to meet the service levels and requirements specified in the RFP.

#### 11.6.2 Transfer of Assets / AMI Solutions

- a) **MVVNL** shall be entitled to serve notice in writing on the AMISP at any time during the Exit Management Period requiring the AMISP and/or its sub-contractor to provide the **MVVNL** with a complete and up to date list of the Assets within 30 (thirty) days of such notice. **MVVNL** shall also be entitled to serve notice in writing on the AMISP at any time prior to the end of the Exit Management Period requiring the AMISP to transfer to the **MVVNL** or its nominated agencies in accordance with Article 11.
- b) In case of contract being terminated by **MVVNL**, **MVVNL** reserves the right to ask AMISP to continue running the project operations for a period of 3 months after termination orders are issued. In case of contract being terminated by AMISP, **MVVNL** reserves the right to ask the AMISP to continue running the project operations for a period of 6 (six) months after termination notice is served by AMISP. In such case,

payments during the Exit Management Period shall be made in accordance with the Article 5.2 and 10.5 (as the case may be).

- c) Upon service of a notice under this Plan, the following provisions shall apply:
  - i. All title to the assets as per the updated detailed bill of quantities for materials and services provided under the Contract shall be transferred to **MVVNL**, on or before the last day of the Exit Management Period.
  - ii. Payment to the outgoing AMISP shall be made to the tune of last set of completed Services / deliverables, subject to SLA requirements.

#### 11.6.3 Cooperation and provision of information

During the Exit Management Period:

- a) AMISP will facilitate / allow the **MVVNL** or its nominated agency access to information reasonably required to define the then current mode of operation associated with the provision of the services to enable the **MVVNL** to assess the existing services being delivered;
- b) Promptly on reasonable request by the **MVVNL**, the AMISP shall provide access to and copies of all information held or controlled by them which they have prepared or maintained in accordance with this Contract relating to any material aspect of the services (whether provided by the AMISP or sub-contractors appointed by the AMISP) to the **MVVNL** or its nominated agency. Such information shall include details pertaining to the list of assets as per updated detailed bill of quantities for materials and services provided under the Contract, services rendered and other performance data. AMISP shall permit the **MVVNL** or its nominated agencies to have reasonable access to its employees and facilities to understand the methods of delivery of the services employed by the AMISP and to assist appropriate knowledge transfer; and
- c) In the event of Termination prior to Installation Milestone, AMISP and **MVVNL** shall jointly appoint an Independent Valuer to certify the value of assets, as per the updated detailed bill of quantities for materials and services provided under the Contract, proposed to be handed over to the **MVVNL** upon termination. The cost of Independent Valuer shall be paid by the

## AMISP.

## 11.6.4 Confidential information, security and data

AMISP shall promptly on the commencement of the Exit Management Period supply to the **MVVNL** or its nominated agency the following:

- a. information relating to the list of assets as per the updated detailed bill of quantities for materials and services provided under the Contract, current Services rendered and consumer and performance data relating to the performance of sub-contractors in relation to the Services;
- b. documentation relating to the Project's Intellectual Property Rights;
- c. documentation relating to sub-contractors;
- d. all current and updated data as is reasonably required for purposes of **MVVNL** or its nominated agencies transitioning the services in a readily available format;
- e. all other information (including but not limited to documents, records and agreements) relating to the services reasonably necessary to enable **MVVNL** or its nominated agencies, to carry out due diligence in order to transition the provision of the Services to **MVVNL** or its nominated agencies, (as the case may be).

## 11.6.5 Transfer of certain agreements

On request by the **MVVNL** or its nominated agency, the AMISP shall affect such assignments, licenses and sub-licenses as **MVVNL** may require in favor of the **MVVNL** or its nominated agency reasonably necessary for the carrying out of replacement services. These agreements may include equipment lease, maintenance or service provision agreement between selected AMISP and third-party lessors, service providers, and any other agreements related to the Services.

## 11.6.6 General obligations of the AMISP during exit management period

- a. The AMISP shall provide all such information as may reasonably be necessary to effect as seamless a handover as practicable in the circumstances to the **MVVNL** or its nominated agency and which the AMISP has in its possession or control at any time during the Exit Management Period.
- b. For the purposes of this Schedule, anything in the possession or control of the AMISP or associated entity, or sub-contractors is deemed to be in the

- possession or control of the AMISP.
- c. The AMISP shall commit adequate resources to comply with its obligations under this Exit Management Schedule.

#### 11.6.7 Exit management process

The AMISP shall prepare an Exit Management Plan for transfer of operations to the **MVVNL** or its nominated agency, in the event of termination or expiry of the contract with the **MVVNL**, without affecting services to stakeholders adversely. AMISP shall get this process approved by **MVVNL**. The Plan shall include, but not be limited to, the following-

- a. A detailed program of the transfer process including details of the means to be used to ensure continuing provision of the Services throughout the transfer process or until the cessation of the Services and of the management structure to be used during the transfer;
- b. Plans for the communication with such of the AMISP's subcontractors, staff, suppliers, customers and any related third party as are necessary to avoid any material detrimental impact on the **MVVNL**'s project operations and AMI Services to other stakeholders as a result of undertaking the transfer;
- c. Plans for provision of contingent support to **MVVNL** or its nominated Agency for a reasonable period after transfer.
- d. The Exit Management Plan including all updates shall be presented by the AMISP to and approved by the **MVVNL** or its nominated agencies.
- e. During the Exit Management Period, the AMISP shall use its best efforts to deliver the services.
- f. Payments during the Exit Management Period shall be made in accordance with the Articles 5.2 and 11.5 (as the case may be)
- g. The Exit Management plan shall be furnished in writing to the **MVVNL** or its nominated agencies within 90(ninety) days from date of execution this AMISP contract
- h. The AMISP shall re-draft the Exit Management Plan annually thereafter to ensure that it is kept relevant and up to date. The updated plan shall be furnished in writing to the **MVVNL** or its nominated agencies within 15 days from the end of such period.

## 12. Liability/

- 12.1 The AMISP hereby agrees to indemnify **MVVNL**, for all



**Indemnity**

conditions and situations mentioned in this Article, in a form and manner acceptable to MVVNL. The AMISP agrees to indemnify MVVNL and its officers, servants, agents (“MVVNL Indemnified Persons”) from and against any costs, loss, damages, expense, claims including those from third parties or liabilities of any kind howsoever suffered, arising or incurred inter alia during and after the Contract Period out of:

- a) any negligence or wrongful act or omission by the AMISP or its agents or employees or any third Party associated with AMISP in connection with or incidental to this Contract; or
- b) any infringement of patent, trademark/copyright or industrial design rights arising from the use of the supplied Solution or any part thereof.

12.2 The AMISP shall also indemnify MVVNL against any privilege, claim or assertion made by third party with respect to right or interest in, ownership, mortgage or disposal of any asset, property, movable or immovable as mentioned in any Intellectual Property Rights, licenses and permits.

12.3 Without limiting the generality of the provisions of the Article 12.1 and 12.2, the AMISP shall fully indemnify, hold harmless and defend MVVNL Indemnified Persons from and against any and all suits, proceedings, actions, claims, demands, liabilities and damages which MVVNL Indemnified Persons may hereafter suffer, or pay by reason of any demands, claims, suits or proceedings arising out of claims of infringement of any domestic or foreign patent rights, copyrights or other intellectual property, proprietary or confidentiality rights with respect to the Solution, information, design or process supplied or used by the AMISP in performing the AMISP’s obligations or in any way incorporated in or related to the Project. If in any such suit, action, claim or proceedings, a temporary restraint order or preliminary injunction is granted, the AMISP shall make every reasonable effort, by giving a satisfactory bond or otherwise, to secure the suspension of the injunction or restraint order. If, in any such suit, action, claim or proceedings, the Solution or any part thereof or comprised therein, is held to constitute an infringement and its use is permanently enjoined, the AMISP shall promptly make every reasonable effort to secure for the MVVNL a license, at no cost to MVVNL, authorizing continued use of the infringing work. If the AMISP is unable to secure such

license within a reasonable time, the AMISP shall, at its own expense, and without impairing the specifications and standards, either replace the affected work, or part, or process thereof.

**(a) Survival on Termination**

**12.4 SURVIVAL ON TERMINATION**

12.4.1 The provisions of this Article 12 shall survive the Termination of the Contract

**(b) Defence of Claim**

**12.5 DEFENCE OF CLAIMS**

12.5.1 If any proceedings are brought or any claim is made against the **MVVNL** arising out of the matters referred to in Article 12, the **MVVNL** shall promptly give the AMISP a notice thereof, and the AMISP may at its own expense and in the **MVVNL**'s name conduct such proceedings or claim and any negotiations for the settlement of any such proceedings or claims.

12.5.2 If the AMISP fails to notify the **MVVNL** within 28 (twenty-eight) days after receipt of such notice that it intends to conduct any such proceedings or claim, then the **MVVNL** shall be free to conduct the same on its own behalf.

12.5.3 The **MVVNL** shall, at the AMISP's request, afford all available assistance to the AMISP in conducting such proceedings or claim, and shall be reimbursed by the AMISP for all reasonable expenses incurred in so doing.

**12.6 LIMITATION OF LIABILITY**

**(c) Limitation of Liability**

12.6.1 Except in cases of gross negligence or wilful misconduct:

- a) Neither Party shall be liable to the other Party for any indirect or consequential loss or damage, loss of use, loss of production, or loss of profits or interest costs, provided that this exclusion shall not apply to any obligation of the AMISP to pay liquidated damages to the **MVVNL**; and
- b) The aggregate liability of the AMISP to the **MVVNL**, whether under the Contract, in tort, or otherwise, shall not exceed the Contract Price. Provided that this limitation shall not apply to the cost of repairing or replacing defective equipment, or to any obligation of the AMISP to indemnify the **MVVNL** with respect to infringement of any Intellectual Property Rights.

**13. Governing Laws and Settlement of Disputes**

- 13.1 The **MVVNL** and the AMISP shall make every effort to resolve amicably any disagreement or dispute arising between them under or in connection with the Contract, by direct informal negotiation.
- 13.2 If the **MVVNL** and the AMISP fail to resolve such a dispute (the date of commencement of the dispute shall be taken from the date when this Article reference is quoted by either Party in a formal communication clearly mentioning existence of dispute or as mutually agreed) or difference by mutual consultation within 28 (twenty-eight) days from the commencement of such consultation, either Party may require that the dispute be referred for resolution to the formal mechanisms specified in this Article 13.
- 13.3 Specifically, for the resolution of disputed payments, All disputes or differences in respect of which the decision, if any, has not become final or binding as aforesaid in Clause 13.2 shall be referred to a dedicated Conciliation committee for RDSS, formulated by Ministry of Power (MoP) for resolution of any disputes under the scheme. This Conciliation Committee shall be an alternate dispute resolution mechanism being put in the place by the MoP. The process shall be in-line with the notification, as and when published by the MoP. If the successful bidder is not willing to take recourse to this process or has any reluctance in this behalf, there shall be no compulsion to take such a recourse. This Conciliation process shall be conducted under Part III of the Arbitration and Conciliation Act, 1996. In the event of the conciliation proceedings being successful, the parties to the dispute would sign the written settlement agreement and the conciliators would authenticate the same. Such settlement agreement would then be binding on the parties in terms of Section 73 of the Arbitration and Conciliation Act, 1996. After successful conclusion of proceedings, the Parties to the conciliation process, have to undertake and complete all necessary actions for implementation of the terms of settlement within a period of 30 days from execution of settlement agreement, unless a different timeline not exceeding 60 days is agreed upon in settlement agreement. All pending claims of parties, in connection with the dispute, before any other legal forum are to be withdrawn within the said 30 days in pursuance of the settlement agreement. In case of failure of the conciliation process at the level of the Conciliation Committee, the parties may withdraw from conciliation process and take

recourse to the laid down legal process of Courts. However, the option of Arbitration would not be available once the conciliation mechanism has been exercised.

13.4 All disputes or differences in respect of which the decision, if any, has not become final or binding as aforesaid in Clause 13.2 or if the parties are not willing to refer the dispute to the CCIE, then the dispute shall be settled by arbitration in the manner hereinafter provided. The arbitration shall be conducted by three arbitrators, one arbitrator each to be nominated by the AMISP and the **MVVNL** and the third to be appointed as the presiding arbitrator by both the arbitrators in accordance with the Arbitration and Conciliation Act, 1996. If either of the parties fails to appoint its nominee arbitrator within 60 (sixty) days after receipt of a notice from the other party invoking the arbitration, the nominee arbitrator appointed by one of the party invoking the arbitration clause shall act as the sole arbitrator to conduct the arbitration under the Arbitration and Conciliation Act 1996, as amended from time to time.

13.5 The arbitration shall be conducted in accordance with the provisions of the Arbitration and Conciliation Act, 1996 or any statutory modification thereof. The seat of arbitration shall be as specified in **SCC**.

13.6 The Contract shall be governed by and interpreted in accordance with laws of India. The Courts, specified in **SCC**, shall have exclusive jurisdiction in all matters arising under this Contract.

13.7 Parties to Perform Obligations: Notwithstanding the existence of any Dispute and difference referred to the Arbitration Tribunal as provided in Article 13.3 and save as the Arbitration Tribunal may otherwise direct by a final or interim order, the Parties hereto shall continue to perform their respective obligations (which are not in dispute) under this Contract.

**14. Change Order**  
**(a) Change Notes /**  
**Change Order to Alter**  
**Number of Meters to**  
**be Installed**

**14.1 Change Notes / Change Order to Alter Number of Meters to be Installed**

Necessity of Change Notes arise due to change in the number of meters against the numbers agreed for the project. Negative variation is permissible only up to the

“Installation Milestone”. Positive variation is however possible at any time during the Contract Period. The variation allowed cannot be more than the minimum and maximum numbers, as specified in **SCC**.

- 14.1.1 Change Notes shall be generated and maintained by the AMISP based on a written communication from the authorised officer(s) of the **MVVNL**. The AMISP shall receive the AMISP Service Charges for additional meters installed and made operational through the means of Change Notes.
- 14.1.2 To establish the revised Total Meter-Months for the project due to additional meters installed, the **MVVNL** shall convert all such Change Notes to Change Orders any time before the Total Meter-Months are completed.
- 14.1.3 In the event a Smart Meter is shifted from one node to another, AMISP shall be entitled to receive the Monthly AMISP Service Charges for such meters as if such smart meter has not been shifted. In other words, this will not increase the total number of meters installed by the AMISP.
- 14.1.4 In the event a Change Note / Change Order causes an increase or decrease in the time required for, the AMISP's performance of any provisions under the Contract, an equitable adjustment shall be made in the Project Implementation Schedule as provided in Clause 12 of Section 6 and the Contract shall accordingly be amended. Any claims by the AMISP or the **MVVNL** for adjustment under this Article must be asserted within 28 (twenty-eight) days from the date of the AMISP's receipt of the Change Note / Change Order. The Parties agree that any change in the delivery and Project Implementation Schedule shall result in a proportional change in the Term of the Contract.
- 14.1.5 An institutional mechanism will be set up for taking decisions regarding requests for changes or New Requirements. The **MVVNL** will set up a Change Control Committee with members from the **MVVNL** and the AMISP. If it is unable to reach an agreement, the decision of the **MVVNL** will be final.
- 14.1.6 In the case of additional meters installed through Change Notes maintained by the AMISP, the **MVVNL** shall convert all such Change Notes to Change Orders any time before the Total Meter-Months are completed.

14.1.7 The price variation for service

**(b) Change Request/  
Change Order for  
New/Enhancements to  
Software Applications**

**14.2 Change Request/Change Order for New/Enhancements to Software Applications**

Another form of change may arise when the **MVVNL** discovers the need to have enhancements in the delivered software applications and/or entirely new functional requirements in the applications (“New Requirements”), subject to Article 14.2.5 of this Contract.

14.2.1 At any point in time the **MVVNL** may raise a Change Request to include New Requirements in the AMI system application. This Change Request shall include the following:

- Identification and documentation of the need for the change
- Functional details of the change
- Information related to initiator, initiation date and
- Priority of the change

14.2.2 The AMISP will analyse and evaluate the Change Request to come up with the estimate of the effort involved in terms of man-days required (in respective skill areas) and time schedule as per agreed priority and document the same. **MVVNL** will use the estimated effort of the new requirements made by the AMISP and together with the quoted man-month rates arrive at a cost estimate. For all technical resources, the quoted man-month rate shall be used. Efforts of support staff shall not be taken into consideration for this purpose.

14.2.3 Based on the agreed cost estimate, the **MVVNL** shall raise a “Change Order”. The AMISP shall undertake the development of the New Requirements only after securing express consent of the **MVVNL**. If the consent of **MVVNL** is not received, then the change will not be carried out. The change will be implemented in accordance to the agreed cost, effort, and schedule by the AMISP and the change will be verified by the **MVVNL** on completion of implementation.

14.2.4 If the Change Order for New Requirements agreed to herein causes an increase or decrease in cost of, or the time required for, firm’s performance of any provisions under the Agreement, equitable adjustments shall be made in the Agreement Price or Delivery Schedule, or both, and the Agreement shall accordingly be amended. Any claims by

firm for adjustment under this must be asserted within 30 (thirty) days from the date of AMISP receiving the change order.

14.2.5 The following categories of Change Requests shall not be treated as “New Requirements” and the AMISP is expected to deliver these Change Requests as per agreed schedule without any commercial implications.

- All bug fixes
- All upgrades of the licensed platforms
- Changes made to report templates
- New reports not exceeding [x] numbers
- Integration with national level systems like NFMS etc.
- Minor changes not requiring more than 10 man-days
- Aspects already covered under existing scope of work provided in this Contract

14.2.6 In the case of New Requirements in Software Applications, **MVVNL** may at any time, by a written Change Request seek changes to be implemented within the general scope of the Agreement provided this does not constitute unrelated work and that it is technically practicable, taking into account both the state of advancement of the Solution and the technical compatibility of the change envisaged with the nature of the Solution as specified in the Contract.

14.2.7 The Change Request/New Requirement management procedure will follow the following steps: -

- i. Identification and documentation of the need for the Change Request/New Requirement - The information related to initiator, initiation date and details of Change Request/New Requirement and priority of the change/New Requirement will be documented by the **MVVNL**.
- ii. Analysis and evaluation of the Change Request/New Requirement - Impact of the change/new requirement in terms of the estimated effort, changed schedule, cost and the items impacted will be analyzed and documented by the AMISP.
- iii. Approval or disapproval of the Change Request/New Requirement – the **MVVNL** will approve or disapprove the Change Request/New Requirements. Once approved the Change Request is converted into a Change Order which is subject to the conditions laid down in Article 14.2.5.

- iv. Implementation of the change/New Requirement – The Change Order/New Requirement will be implemented in accordance with the agreed cost, effort, and schedule by the AMISP.
- v. Verification of the change/New Requirement - The Change Order/New Requirement will be verified by the **MVVNL** on implementation of the change request.

## 15. Miscellaneous

### (a) Waiver

#### 15.1 WAIVER

15.1.1 Subject to Article 15.1.2, no relaxation, forbearance, delay, or indulgence by either Party in enforcing any of the terms and conditions of the Contract or the granting of time by either Party to the other shall prejudice, affect, or restrict the rights of that Party under the Contract. Neither shall any waiver by either Party of any breach of Contract operate as waiver of any subsequent or continuing breach of Contract.

15.1.2 The waiver by either Party of a breach or default of any of the provisions of this Contract by the other Party shall not be interpreted as:

- a) A waiver of any succeeding breach of the same or other provision, nor shall any delay or omission on the part of the other Party to exercise; or
- b) A way to avail itself of any right, power, or privilege that it has or may have under this contract to operate as waiver of any breach or default by the other Party.
- c) Any waiver of a Party's rights, powers, or remedies under the Contract must be in writing, dated, and signed by an authorized representative of the Party granting such waiver, and must specify the right and the extent to which it is being waived.

### (b) Extension of Time

#### 15.2 EXTENSIONS OF TIME

15.2.1 If at any time during performance of the Contract, the AMISP or its subcontractors should encounter conditions impeding timely delivery of the Goods or completion of Related Services pursuant to this Contract, the AMISP shall promptly notify the **MVVNL** in writing of the delay, its likely duration, and its cause. As soon as practicable



after receipt of the AMISP's notice, the **MVVNL** shall evaluate the situation and may at its discretion extend the AMISP's time for performance, in which case the extension shall be ratified by the Parties by amendment of the Contract.

15.2.2 Except in case of Force Majeure, as provided in Article 9 or where the delay in delivery of the Goods or completion of Related Services is caused due to any delay or default of the **MVVNL**, any extension granted under Article 15.2.1 shall not absolve the AMISP from its liability to the pay of liquidated damages pursuant to Article 7. Time will be the essence of the Contract and no variation shall be permitted in the delivery time/delivery schedule mentioned in the order unless agreed by the **MVVNL**. The AMISP is expected to implement the systems for the project area as per the schedule indicated in the Contract.

### 15.3 INSURANCE

#### (c) Insurance

15.3.1 The Goods supplied under the Contract shall be fully insured by the AMISP against loss or damage incidental to manufacture or acquisition, transportation, storage, and delivery.

15.3.2 The AMISP shall furnish to the **MVVNL** copies of certificates and policies of the Insurances as soon as they are affected and renewed by or on behalf Of the AMISP from time to time in terms of Article 15.

### 15.4 TRANSPORTATION

#### (d) Transportation

15.4.1 The AMISP shall at its own risk and expense transport all the AMISP's equipment to the site by the mode of transport that the AMISP judges most suitable under all the circumstances.

15.4.2 Unless otherwise provided in the Contract, the AMISP shall be entitled to select any safe mode of transport operated by any person to carry the AMISP's equipment.

15.4.3 The AMISP shall be responsible for obtaining, if necessary, approvals from the authorities for transportation of the AMISP's equipment to the Project site. **MVVNL** shall use its best endeavours in a timely and expeditious manner to assist the AMISP in obtaining such approvals, if requested by the AMISP.

### 16. Confidential

16.1 Both AMISP and the **MVVNL** undertake to each other to

**Information**

keep confidential all information (written as well as oral) concerning the business and affairs of the other, which has been obtained or received as a result of the discussions leading up to or the entering of the Contract.

16.2 After the entering of the Contract, the **MVVNL**/MVVNL and the AMISP shall keep confidential and shall not, without the written consent of the other Party hereto, divulge to any third party any documents, data, or other information furnished directly or indirectly by the other Party hereto in connection with the Contract, whether such information has been furnished prior to, during or following completion or termination of the Contract. Notwithstanding the above, the AMISP may furnish to its subcontractors such documents, data, and other information it receives from the **MVVNL** to the extent required for the subcontractors to perform its work under the Contract, in which event the AMISP shall obtain from such subcontractors an undertaking of confidentiality similar to that imposed on the AMISP under this Article 16.

16.3 The **MVVNL** shall not use such documents, data, and other information received from the AMISP for any purposes unrelated to the Contract. Similarly, the AMISP shall not use such documents, data, and other information received from the **MVVNL** for any purpose other than the design, procurement, or other work and services required for the performance of the Contract.

16.3.1 The obligation of a Party under Articles 15.1 and 15.2 above, however, shall not apply to information that:

- a) **MVVNL** or AMISP need to share with the institutions participating in the financing of the Contract;
- b) now or hereafter enters the public domain through no fault of that Party;
- c) can be proven to have been possessed by that Party at the time of disclosure and which was not previously obtained, directly or indirectly, from the other Party; or
- d) Otherwise lawfully becomes available to that Party from a third Party that has no obligation of confidentiality.

16.3.2 The above provisions of this Article 16 shall not in any way modify any undertaking of confidentiality given by either of the Parties hereto prior to the date of execution of the Contract in respect of the Supply or any part thereof.

16.3.3 Each of the Parties to this Contract, undertakes to the other to take all such steps as shall from time to time be necessary to ensure compliance with the provisions of the above Articles by its employees, agents and sub-contractors.

16.3.4 The provisions of this Article 16 survive completion or termination, for whatever reason, of the Contract.

### **17. Subcontracting**

17.1 The AMISP shall be permitted to appoint subcontractor(s) so as to meet its obligations under the Contract with the **MVVNL**, with intimation to the **MVVNL**, provided they ensure that any person engaged by AMISP are not blacklisted by any Government organization or regulatory agencies or Government Undertaking as on the date of intimation to the **MVVNL** (as defined under the Section 2 of this RFP).

17.2 AMISP shall engage only such sub-contractor(s) who satisfy the eligibility requirement in terms of applicable laws including the guidelines issued vide Order No. F/No.6/18/2019-PPD by Ministry of Finance, Department of Expenditure, Public Procurement Division dated 23 July 2020 and as amended from time to time.

### **18. Warranty**

18.1 The AMISP warrants that all the Goods that would be used as part of Solution would be new, unused, and of the most recent or current models, and that they incorporate all recent improvements in design and materials, unless provided otherwise in the Contract.

18.2 The AMISP further warrants that the Goods shall be free from defects arising from any act or omission of the AMISP or arising from design, materials, and workmanship, under normal use in the conditions prevailing in the country of final destination.

18.3 The warranty of the AMI system shall remain valid till expiry of the Contract Period.

18.4 The AMISP shall be responsible for comprehensive maintenance of all the equipment and systems supplied & installed under this Contract during the Operational Period. There may be some variation during detailed engineering. AMISP will have to make their own assessment of the systems and deploy manpower accordingly. However, it is to be ensured that specified manpower of requisite

qualification is deployed.

**18.5** The maintenance of the system supplied & installed by the AMISP shall be comprehensive. The AMISP shall be responsible for providing all the spares as may be required. The spares shall be maintained by the AMISP at no extra cost to the **MVVNL**.

18.6 At the end of the contract or at the time of transfer in case of termination under article 11, the meters shall have a warranty of five years from their installation.

## **19. Change in Laws and Regulations**

19.1 Unless otherwise specified in the Contract, if after the Bid Submission Deadline indicated in **SCC**, any law, regulation, ordinance, order or bylaw having the force of law is enacted, promulgated, abrogated, or changed in India where the sites is located (which shall be deemed to include any change in interpretation or application by the competent authorities) that subsequently affects the project delivery, then such delivery shall be correspondingly amended, to the extent that the AMISP has thereby been affected in the performance of any of its obligations under the Contract.

19.2 The Party affected by a change in law shall give notice giving details of the likely impact of the change in law. The Parties shall negotiate in good faith to place the affected party at the same economic position as if no change in law had occurred. Provided only such change in law events which have financial impact beyond a threshold specified in **SCC**, are to be considered for the purposes of grant of relief to the affected Party.

19.3 Notification of Change In Law: If the AMISP is affected by a Change in Law in accordance with Article 19.1 and wishes to claim relief for such Change in Law under this Article 19, it shall give notice to the **MVVNL** of such Change in Law as soon as reasonably practicable after becoming aware of the same. Any notice served pursuant to Articles 18 shall provide, amongst other things, precise details of the Change in Law and its effect on the AMISP.

## **20. Severability**

20.1 If any provision or condition of the Contract is prohibited or rendered invalid or unenforceable, such prohibition, invalidity or unenforceability shall not affect the validity or enforceability of any other provisions and conditions of the Contract or the

Contract as a whole and the remaining provisions of the Contract shall remain in full force and effect.

## 21. Language

21.1 The official language of the Contract is English. Contract as well as all correspondence and documents relating to the Contract exchanged by the AMISP and MVVNL, shall be written in English. Supporting documents and printed literature that are part of the Contract may be in another language provided they are accompanied by an accurate translation of the relevant passages in English, in which case, for purposes of interpretation of the Contract, the English translation shall govern.

21.2 The AMISP shall bear all costs of translation to English and all risks of the accuracy of such translation. The AMISP shall be bound to the English translation and what has been stated therein.

## 22. Assignment

22.1 The AMISP shall not assign, in whole or in part, their obligations under this Contract without prior permission of the MVVNL.

22.2 The permission for assignment of whole or part of the AMISP's obligations of this contract shall only be requested/permitted at least two years after Installation Milestone.

22.3 However, in case of default by the AMISP in debt repayments or in the event of default by the AMISP as per Clause 11 of Section 7, the MVVNL may, on an application from the Lenders, assign the work under the AMISP contract to the nominee of the Lenders subject to the fulfilment of the qualification requirements and provisions of the Contract.

## 23. Entire Agreement

23.1 This Contract along with all its annexures, schedule and the provisions of the RFP reflect the entire understanding of the Parties.

23.2 No variation or modification of the terms of the Contract shall be made except by written amendment signed by the Parties.

## 24. Disclaimer

24.1 MVVNL reserves the right to share, with any consultant of its choosing, any resultant proposals in order to secure expert opinion.

24.2 MVVNL reserves the right to accept any proposal deemed to be

in the best interest of the **MVVNL**.

## **25. Public Disclosure**

- 25.1 All materials provided to **MVVNL** by the AMISP may be disclosed in accordance with the provisions of applicable law including but not limited to the Right To Information Act, 2005 (RTI), etc.
- 25.2 The AMISP's team shall not make or permit to be made a public announcement or media release about any aspect of this Contract unless **MVVNL** first gives the AMISP its written consent.

## **26. Adherence to Safety Procedures, Rules, Regulations and Restriction**

- 26.1 AMISP shall comply with the provision of all laws including labour laws, rules, regulations and notifications issued there under from time to time. All safety and labour laws enforced by statutory agencies and by **MVVNL** shall be applicable in the performance of this Contract and AMISP's team shall abide by these laws.
- 26.2 Access to the **MVVNL**'s locations shall be strictly restricted. No access to any person except the designated personnel belonging to the AMISP who are genuinely required for execution of work or for carrying out management/maintenance who have been explicitly authorized by **MVVNL** shall be allowed entry to the **MVVNL**'s locations. Even if allowed, access shall be restricted to the pertaining equipment of **MVVNL** only. The AMISP shall maintain a log of all such activities.
- 26.3 The AMISP shall take all measures necessary or proper to protect the personnel, work and facilities and shall observe all reasonable safety rules and instructions. AMISP's team shall adhere to all security requirement/regulations of **MVVNL** during the execution of the work. **MVVNL**'s employees and associates also shall comply with safety procedures/policy.
- 26.4 The AMISP shall report as soon as possible any evidence, which may indicate or is likely to lead to an abnormal or dangerous situation and shall take all necessary emergency control steps to avoid such abnormal situations.
- 26.5 **MVVNL** will be indemnified for all the situations mentioned in this Article in the similar way as defined in Article 12.

## **27. Non- Solicitation of**

- 27.1 The Articles of this contract, which by nature are intended to

- Staff** survive termination of this Contract, shall remain in effect after such termination
- 28. Survival**
- 28.1 The Articles of this contract, which by nature are intended to survive termination of this Contract, shall remain in effect after such termination.
- 28.2 In the event AMISP is a consortium and a Party proposes to cease to be a member of the Consortium it shall send a notice to the **MVVNL** and all other members of the Consortium. In the event no objection is received from the **MVVNL** and/ or other Consortium Member within 15 days of the receipt of notice, the Consortium Member shall be entitled to leave the Project after giving a notice of 7 days.
- 28.3 Notwithstanding that exit of any member of the consortium the Lead Consortium Member shall be responsible for development of the Project and compliance with the terms and conditions of this AMISP Contract.
- 28.4 In the event Lead Consortium Member proposes to bring in a new entity for implementation of the Project, such new entity shall execute a deed of adherence stating that it shall comply with the provisions of the Consortium Agreement and the AMISP Contract. Also, the new entity, as on date of replacement shall, satisfy the qualification requirements as mentioned in section 3: Eligibility and Qualification requirements.
- 29. Notices**
- 29.1 All notices to be given under this Contract shall be in writing and in the English language.
- 29.2 A Notice shall be effective when delivered or on the notice effective date, whichever is later.
- 29.3 All notices must be delivered personally, by registered or certified mail or by facsimile transmission or email.
- 29.4 All notices shall be effective:
- a) If sent by facsimile transmission or email, when sent (on receipt of confirmation of the correct number or address);
  - b) If sent by registered post or certified mail, within 5 (five) days of dispatch;
  - c) If delivered personally, on receipt by intended recipient, provided that all notices given by facsimile transmission

shall be confirmed by registered or certified mail.

29.5 Each party shall forthwith notify the other party of any change in its address to which notices under this Contract are to be delivered, mailed or facsimiled.

### 30. Additional Security

30.1 The AMISP has furnished Additional Security in the form of an irrevocable bank guarantee valid up to a period of 6 (six) months beyond a period of two years after the Installation Milestone or extended thereafter, for the amount indicated in **SCC** on the prescribed format. However, in case of delay in Installation Milestone, the validity of the initial Additional Security shall be extended by the period of such delay. In the event delay is solely due to acts and/ or omission of the **MVVNL** cost of extending the validity of Additional security shall be reimbursed to the AMISP by the **MVVNL**.

30.2 Any payments shall be made to the AMISP only after receipt of the additional security by **MVVNL**.

30.3 Upon achievement of the Installation Milestone, the value of the additional security shall be reduced by AMISP, to the extent indicated in **SCC** as determined in accordance with numbers of meters considered for Installation Milestone.

30.4 Upon Termination of the Contract due to **MVVNL** Event of default or completion of a period of two years after the installation milestone, the additional Security shall be discharged by **MVVNL** without any interest and returned to the AMISP not later than 14 (fourteen) working days following the date of Termination of the Contract or completion of a period of two years after the installation milestone.

30.5 Upon Termination of the Contract due to AMISP Event of default, the additional security shall be forfeited by **MVVNL**.

30.6 In case of any delay by the AMISP in performing the activities of the scope of work with respect to the Project Implementation Schedule, then upon **MVVNL**'s request, the AMISP shall extend the validity of the additional Security for the period for which the installation milestone is extended. In the event delay is solely due to acts and/ or omission of the **MVVNL** cost of extending the validity of additional Security shall be reimbursed to the AMISP by the **MVVNL**.

### 31. ~~Advance Payment security (Optional)~~

~~32.1 **MVVNL**, at its discretion, may provide to the successful bidder an interest-bearing advance payment against an advance payment security furnished by the successful bidder in the form of a bank guarantee for [10] % of the Contract Price.~~

~~32.2 Within 14 (fourteen) Days of the receipt of Letter of Award from the **MVVNL**, the Successful Bidder shall furnish the Advance Payment Security, using for that purpose the format of Advance payment Security given in Form 4 in Section 8.~~



32.3 ~~The MVVNL shall provide an advance payment for [70] % of the advance payment security furnished by the successful bidder, at the time of contract signing.~~

32.4 ~~The amount of the security shall be reduced in proportion to the value of the services executed by and paid to the successful bidder from time to time and shall automatically become null and void when the full amount of the advance payment has been recovered by the MVVNL. The security shall be returned to the successful bidder immediately after its expiration~~

32.5 ~~The interest rate on advance payment shall be Marginal Cost of Funds Based Lending Rate (MCLR) for one year of the State Bank of India, prevailing on the date of advance payment to the Successful Bidder. The interest accrued on interest bearing advance shall be adjusted first before releasing any payment. The interest rate shall be calculated on the daily progressive balances outstanding as on the date of recovery/adjustment i.e., on daily rest basis.]~~

### III. Special Conditions of Contract

GCC Article/ Clause	Amendments of, and Supplements to, Clauses in the General Conditions of Contract																																										
1.1 (j)	<p><del>&lt; Utility to indicate whether if SPV is applicable or SPV is not applicable &gt;</del>            SPV is allowed to Participate in bidding process</p>																																										
1.2.12	<p>The methodology for determining the ‘Total Meter-Months’ as well as ‘Operation and Maintenance Period of the AMI system’ is provided below:</p> <p>Assuming a deployment of 1 million Smart Meters to be installed in Project area A, ‘Total Meter-Months’ is determined as below:  <b>‘Total Meter-Months’</b> = (Total number of smart Meters to be installed in the AMI Project X 90 months) = 1 million meters X 90 months = 90 million meter-months (A)</p> <p>The implementation of the AMI system is aligned to the schedule provided above. This implies the following:</p> <ol style="list-style-type: none"> <li>50,000 Smart Meters (5% of total) are operationalized at the end of 9<sup>th</sup> Month from date of execution of the Contract;</li> <li>From there on, ~40,909 Smart Meters (4.09% of total) are operationalized every month till 500,000 Smart Meters (50% of total) are operationalized at the end of 20<sup>th</sup> Month from date of execution of the Contract;</li> <li>From there on, 50,000 Smart Meters (5 % of total) are operationalized every month till 1,000,000 smart meters (100% of total) are operationalized at the end of 30<sup>th</sup> Month from date of execution of the Contract.</li> </ol> <p>The accrual of meter-months will commence as soon as the first lot of 5% of total Smart Meters are installed and operationalized at the end of 9<sup>th</sup> Month from date of execution of the Contract. Hence, ‘Meter-Months’ of AMI system operated after operational go-live is determined as below:</p> <table border="1" data-bbox="467 1377 1328 1875"> <thead> <tr> <th>Month</th> <th>Total Smart Meters Installed</th> <th>Meter-Months</th> </tr> </thead> <tbody> <tr><td>9</td><td>50,000</td><td>0</td></tr> <tr><td>10</td><td>90,909</td><td>50,000</td></tr> <tr><td>11</td><td>131,818</td><td>90,909</td></tr> <tr><td>12</td><td>172,727</td><td>131,818</td></tr> <tr><td>13</td><td>213,636</td><td>172,727</td></tr> <tr><td>14</td><td>254,545</td><td>213,636</td></tr> <tr><td>15</td><td>295,455</td><td>254,545</td></tr> <tr><td>16</td><td>336,364</td><td>295,455</td></tr> <tr><td>17</td><td>377,273</td><td>336,364</td></tr> <tr><td>18</td><td>418,182</td><td>377,273</td></tr> <tr><td>19</td><td>459,091</td><td>418,182</td></tr> <tr><td>20</td><td>500,000</td><td>459,091</td></tr> <tr><td>21</td><td>550,000</td><td>500,000</td></tr> </tbody> </table>	Month	Total Smart Meters Installed	Meter-Months	9	50,000	0	10	90,909	50,000	11	131,818	90,909	12	172,727	131,818	13	213,636	172,727	14	254,545	213,636	15	295,455	254,545	16	336,364	295,455	17	377,273	336,364	18	418,182	377,273	19	459,091	418,182	20	500,000	459,091	21	550,000	500,000
Month	Total Smart Meters Installed	Meter-Months																																									
9	50,000	0																																									
10	90,909	50,000																																									
11	131,818	90,909																																									
12	172,727	131,818																																									
13	213,636	172,727																																									
14	254,545	213,636																																									
15	295,455	254,545																																									
16	336,364	295,455																																									
17	377,273	336,364																																									
18	418,182	377,273																																									
19	459,091	418,182																																									
20	500,000	459,091																																									
21	550,000	500,000																																									

	<table border="1"> <tr><td>22</td><td>600,000</td><td>550,000</td></tr> <tr><td>23</td><td>650,000</td><td>600,000</td></tr> <tr><td>24</td><td>700,000</td><td>650,000</td></tr> <tr><td>25</td><td>750,000</td><td>700,000</td></tr> <tr><td>26</td><td>800,000</td><td>750,000</td></tr> <tr><td>27</td><td>850,000</td><td>800,000</td></tr> <tr><td>28</td><td>900,000</td><td>850,000</td></tr> <tr><td>29</td><td>950,000</td><td>900,000</td></tr> <tr><td>30</td><td>1,000,000</td><td>950,000</td></tr> <tr><td><b>Total</b></td><td><b>1,000,000</b></td><td><b>10,050,000</b></td></tr> </table> <p>Basis the above table, the AMI System would have been already operational for 10,050,000 meter-months prior to Installation Milestone (B)  Hence, AMI system will remain operational for the remaining Contract period, i.e.,  = [‘Total Meter-Months’ (A) – ‘Meter-Months’ of prior to Installation Milestone (B)] (C)  = (90,000,000 – 10,050,000) meter-months  = 79,950,000 meter-months (C)  Time period (in months) for operating AMI system after Installation Milestone is,  = [Remaining ‘Meter-Months’ / (Total number of Smart Meters installed in the AMI Project)] (D)  = 79,950,000 / 1,000,000  = ~79.95 months  Hence the Total <b>‘Operation and Maintenance period of the AMI system’</b>  = (Months of operating Smart meters prior to Installation Milestone + ‘Months’ of operating AMI system after Installation Milestone) = 21 months + 79.95 months = 100.95 months</p> <p>The above methodology has been illustrated in the graphic at <b>Annexure I (SCC)</b></p>	22	600,000	550,000	23	650,000	600,000	24	700,000	650,000	25	750,000	700,000	26	800,000	750,000	27	850,000	800,000	28	900,000	850,000	29	950,000	900,000	30	1,000,000	950,000	<b>Total</b>	<b>1,000,000</b>	<b>10,050,000</b>
22	600,000	550,000																													
23	650,000	600,000																													
24	700,000	650,000																													
25	750,000	700,000																													
26	800,000	750,000																													
27	850,000	800,000																													
28	900,000	850,000																													
29	950,000	900,000																													
30	1,000,000	950,000																													
<b>Total</b>	<b>1,000,000</b>	<b>10,050,000</b>																													
<b>5.1.1</b>	Contract Price is INR [X] <MVVNL to insert to figure based on the total project cost as provided in Form 1 given in Section 5>																														
<b>5.2.3</b>	<table border="1"> <thead> <tr> <th>S. No.</th> <th>Deliverable</th> <th>Payment</th> </tr> </thead> <tbody> <tr> <td>1.</td> <td> <ul style="list-style-type: none"> <li>i. Monthly documentation/ records/ test certificates/ etc. during Post-Operational Go-Live Phase</li> <li>a. Monthly progress report briefing the status of installation of meters, meter boxes and service cables on pro-rata basis,</li> </ul> </td> <td>= AMISP Service Charge (as per Table- Bill of Materials and Services for Smart Meters in Form 1 given in Section 5) X total number of meters in operation and maintenance phase at the end of each month Post-Operational Go-Live</td> </tr> </tbody> </table>	S. No.	Deliverable	Payment	1.	<ul style="list-style-type: none"> <li>i. Monthly documentation/ records/ test certificates/ etc. during Post-Operational Go-Live Phase</li> <li>a. Monthly progress report briefing the status of installation of meters, meter boxes and service cables on pro-rata basis,</li> </ul>	= AMISP Service Charge (as per Table- Bill of Materials and Services for Smart Meters in Form 1 given in Section 5) X total number of meters in operation and maintenance phase at the end of each month Post-Operational Go-Live																								
S. No.	Deliverable	Payment																													
1.	<ul style="list-style-type: none"> <li>i. Monthly documentation/ records/ test certificates/ etc. during Post-Operational Go-Live Phase</li> <li>a. Monthly progress report briefing the status of installation of meters, meter boxes and service cables on pro-rata basis,</li> </ul>	= AMISP Service Charge (as per Table- Bill of Materials and Services for Smart Meters in Form 1 given in Section 5) X total number of meters in operation and maintenance phase at the end of each month Post-Operational Go-Live																													

		<p>including problems that arise with the installed AMI system (if any) as well any cyber security related issues and corrective action taken by AMISP for the same;</p> <p>b. Change Notes</p> <p>c. Reports as mentioned in this Contract which includes but not limited to the following:</p> <p>i. Service Level Agreement (SLA) performance report;</p> <p>ii. Energy Audit report;</p> <p>iii. Other reports as per mentioned in Clause 6.2.2 of the Section 6;</p>	<p>Plus</p> <p>Lumpsum (Rs. 900/- each type meter) payment rate per meter (as per Table-Bill of Materials and Services for Smart Meters in Form 1 given in Section 5) X total number of new smart meters installed and integrated for which Lumpsum payment has not been made earlier, if any</p> <p>Plus</p> <p>Lumpsum payment towards installation and commissioning of auxiliary components (e.g. service cable, <del>DT cable</del> etc.) on pro-rata basis (based on unit rate X quantity installed and commissioned) related to each meter (as per Table-Bill of Materials and Services for Smart Meters in Form 1 given in Section 5)</p> <p>Plus</p> <p>Payment towards change request/new requirement completed, if any (as per Table- Bill of Materials and Services for Smart Meters in Form 1 given in Section 5)</p> <p>Plus</p> <p>Agreed rate for replacement of meters X</p>
--	--	---	---

			<p>Number of meters replaced due to vandalism, theft, etc.</p>
2.		<p>Quarterly documentation/ records/ test certificates/ etc. during Post-Operational Go-Live Phase</p> <ul style="list-style-type: none"> <li>a. As-Built Drawings;</li> <li>b. Updated consumer indexing as per the implemented AMI system;</li> </ul>	<p>&lt;To be made on every third month of each quarter of the Contract Period as defined by the <b>MVVNL</b>&gt;</p> <p>= AMISP Service Charge X total number of meters in operation and maintenance phase at the end of each month Post-Operational Go-Live</p> <p>Plus</p> <p>Lumpsum payment rate per meter X total number of new smart meters installed and integrated for which Lumpsum payment has not been made earlier, if any</p> <p>Plus</p> <p>Payment towards change request/new requirement completed, if any</p> <p>Plus</p> <p>Agreed rate for replacement of meters X Number of meters replaced due to vandalism, theft, etc.</p>

	3.	<p>Annual documentation/ records/ test certificates/ etc. during Post-Operational Go-Live Phase</p> <ol style="list-style-type: none"> <li>a. Cyber Security Audit;</li> <li>b. Data Privacy Audit report;</li> <li>c. Updated Exit Management Plan</li> </ol>	<p><i>&lt;To be made on every last month of each year of the Contract Period as defined by the <b>MVVNL</b>&gt;</i></p> <p>= AMISP Service Charge X total number of meters in operation and maintenance phase at the end of each month Post-Operational Go-Live</p> <p>Plus</p> <p>Lumpsum payment rate per meter X total number of new smart meters installed and integrated for which Lumpsum payment has not been made earlier, if any</p> <p>Plus</p> <p>Payment towards change request/new requirement completed, if any</p> <p>Plus</p> <p>Agreed rate for replacement of meters X Number of meters replaced due to vandalism, theft, etc.</p>
<b>6.1</b>	[3% of the Contract Price or as per the prevalent GoI guidelines/ Orders], if the selected bidder is a consortium or a Sole Bidder		
<b>6.2</b>	[1.5] % of the Contract Price, if the selected bidder is a consortium or a Sole Bidder		
<b>7.3</b>	An illustrative example for arriving at the deductions is given in <b>Annexure III(SCC)</b>		
<b>7.4</b>	A sum equivalent to [1]% of the Contract Price		
<b>11.5.3 (a)</b>	[60] %		

<b>11.5.3 (b)</b>	[100]%
<b>11.5.3 (c) i</b>	[60]%
<b>11.5.3 (c) ii</b>	[100]%
<b>11.5.4 (a)</b>	[10.5]%
<b>13.4</b>	UPPCL at Lucknow and MVVNL at Lucknow
<b>13.5</b>	UPPCL at Lucknow and MVVNL at Lucknow
<b>14.1</b>	[-20%] to [+30%]
<b>19.1</b>	<indicate the Bid Submission Deadline date>
<b>19.2</b>	[0.2 % of the Contract Price]
<b>30.1</b>	<p>[2.5] % of the Contract Price, in case the share of equity participation in the SPV of any consortium member is less than 10% or if any consortium member is not willing to be a part of the SPV to be formed, except in the case when the said consortium member is a CPSE/ PSU or a subsidiary/ Joint venture of a CPSE/ PSU.</p> <p>If a Central Public Sector Enterprise (CPSE) / Public Sector Undertaking (PSU) or Subsidiary/ Joint Venture of a CPSE/ PSU is either the sole Bidder or a lead member of a Bidding Consortium, the bidder shall be exempted from providing an additional security.</p>
<b>30.3</b>	[1.25] % of the Contract Price, in case the share of equity participation in the SPV of any consortium member is less than 10% or if any consortium member is not willing to be a part of the SPV to be formed, except in the case when the said consortium member is a CPSE/ PSU or a subsidiary/ Joint venture of a CPSE/ PSU.

# Annexure I (SCC)

## Graphic Illustration

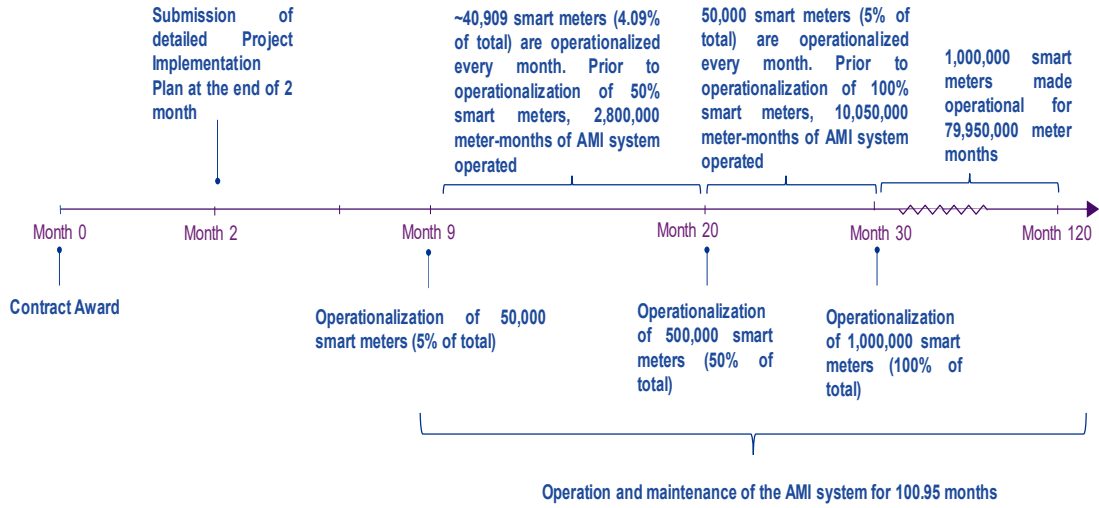



**Annexure III (SCC)**

< For example, in case AMISP delays installation of say 100 similar type of meters by say 5.5 months out of a total meter installation of 1000 meters assuming AMISP Service Charges as Rs. 50 /meter/month for such meter. Liquidated Damages would be worked as  $5 \times 50 \times 100 \times 50\% = \text{Rs. } 12,500$ . Maximum Liquidated Damages that can be deducted in case of delay of say 13 months is limited to 12 months i.e.,  $12 \times 50 \times 100 \times 50\% = \text{Rs. } 30,000$ . Further, Liquidated Damages will be levied as per the delay of Goods i.e., if 80 meters are implemented after 5 months of delay and rest 20 meters are implemented after 12 months of delay, then LD would be  $5 \times 80 \times 50 \times 50\% + 12 \times 20 \times 50 \times 50\% = \text{Rs. } 16,000$ . In the event more than one type of meter are delayed, the LD would be calculated for each category of the meter on basis of their respective AMISP Service Charge >

**Appendix A – Project Requirements (AMI System Requirements and Service Level Agreement)**

*[This Appendix shall include Section 6 of the RFP Document including all amendments/clarification etc. thereto]*

**Appendix B - AMISP Charges including AMISP Service Charges**

*[This Appendix shall include Bill of Material given in Section 5 of the RFP Document and the charges agreed therefor]*

## **PART III**

### **Contract Related Forms**

## Section 8. Contract Related Forms

Form No.	Document
1	Performance Security as per the format prescribed in Form 1
2	Letter of Award as per the format prescribed in Form 2
3	Additional security as per the format prescribed in Form 3
4	Format for Bank Guarantee for Advance payment in Form 4 ( <i>Optional</i> )
5	Format for Direct Debit Facility

## Form 1: Format of Performance Security

*[To be on non-judicial stamp paper of Rupees One Hundred Only (INR 100/-) or appropriate value as per Stamp Act relevant to place of execution, duly signed on each page.]*

Reference No. .... Bank Guarantee No. .... Dated: .....

To:

[MVVNL]

[Address]

Dear Sir/ Madam,

WHEREAS..... *[Insert name of the Lead Consortium Member/ Sole Bidder]* with address ..... *[Insert address of the Lead Consortium Member/ Sole Bidder]* having its registered office at ..... *[Insert address of the Lead Consortium Member/ Sole Bidder]* (hereinafter, the “Contractor”), subsequent to participation in Tender No. [Tender Details] (the “RFP”) issued by [MVVNL] (hereinafter, the “Beneficiary”) for Appointment of AMI Service Provider for Implementation of AMI Project in pre-paid mode, have been issued the Letter of Award as the Selected Bidder. The Selected Bidder was required to incorporate the AMISP. Further the AMISP was required to furnish a Performance Security in the form of a Bank Guarantee

And WHEREAS a Bank Guarantee for Rupees ..... *[Insert amount in words equivalent]* (.....) *[Insert amount in figures]* valid till..... *[Insert Contract Period]* is required to be submitted by the AMISP as per the terms and conditions of the RFP.

We,.....*[Insert name of the Bank and address of the Branch giving the Bank Guarantee]* having our registered office at .....*[Insert address of the registered office of the Bank]* hereby give this Bank Guarantee No. ....*[Insert Bank Guarantee number]* dated .....*[Insert the date of the Bank Guarantee]*, and hereby agree unequivocally and unconditionally to pay immediately on demand in writing from the Beneficiary any officer authorized by it in this behalf any amount not exceeding Rupees ..... *[Insert amount in words]* (.....) *[Insert amount in figures]* to the said Beneficiary on behalf of the Contractor.

We ..... *[Insert name of the Bank]* also agree that non-performance, delayed performance or violation of any of the terms and conditions of the contract by AMISP would constitute a default on the part of the Bidder and that this Bank Guarantee is liable to be invoked and encashed within its validity by the Beneficiary in case of any occurrence of a default on the part of the AMISP or the Selected Bidder and that the encashed amount is liable to be forfeited by the Beneficiary.

This agreement shall be valid and binding on this Bank up to and inclusive of ..... *[Insert the date of validity of the Bank]* and shall not be terminable by notice or by Guarantor change in the constitution of the Bank or the firm of the Bidder Or by any reason whatsoever and our liability hereunder shall not be impaired or discharged by any extension of time or variations or

alternations made, given, conceded with or without our knowledge or consent by or between the Bidder and the Beneficiary.

NOTWITHSTANDING anything contained hereinbefore, our liability under this guarantee is restricted to Rupees ..... [Insert amount in words equivalent]. Our Guarantee shall remain in force till ..... [Insert the contract period]. Unless demands or claims under this Bank Guarantee are made to us in writing on or before..... [Insert contract period], all rights of the Beneficiary under this Bank Guarantee shall be forfeited, and we shall be released and discharged from all liabilities there under.

[Insert the address of the Bank with complete postal branch code, telephone and fax numbers, and official round seal of the Bank]

[Insert signature of the Bank's Authorized Signatory]

Attested:

..... [Signature] (Notary Public)

Place: ..... Date: .....

---

**INSTRUCTIONS FOR SUBMITTING BANK GUARANTEE**

1. Bank Guarantee to be executed on non-judicial stamp paper of appropriate value as per Stamp Act relevant to place of execution.
2. The Bank Guarantee by Bidder shall be given from the Scheduled Commercial Banks.

## Form 2: Format of Letter of Award

Sub: Bid for Appointment of AMISP for Smart Prepaid Metering on DBFOOT basis

REF: - 1. Request for Proposal for selection of AMISP dated [•] (“RFP”)  
 2. Your proposal dated [•] (“Proposal”)  
 3. Your clarification [•]

Dear Sir,

1. This is in reference to your Proposal in relation to the RFP.
2. Pursuant to the evaluations of the Bid, your bid has been found to be most suited.
3. *< applicable in the event the Selected Bidder is a sole bidder or a bidding Consortium with the lead consortium member not being a CPSE/ PSU or subsidiary/ Joint venture of a CPSE/ PSU >* You are requested to please take steps for incorporation of the SPV in terms of the RFP for execution of the AMISP Contract. The execution of the AMISP Contract shall happen only after you have furnished the performance security in terms of the RFP.
4. A draft of the AMISP Contract was provided to you along with the RFP. Please note that there shall be no change whatsoever in the terms and conditions as set out in the draft Contract.
5. Please note that in the event of failure to comply with any terms and conditions of this Letter of Award, the entire Bid Security may be forfeited.
6. Any further correspondence in connection with the Project should be addressed to the [insert details of the appropriate authority •]” with a copy to Chairman/ Managing Director, till further instructions are issued.
7. The terms and conditions as set out in this Letter of Award shall stand valid until execution of the AMISP Contract.
8. Please acknowledge the receipt and return the duplicate copy of this Letter of Award after signing and stamping it in all the pages to the undersigned as a token of acceptance.

Thanking You

Yours truly  
 [insert details of the **MVVNL**]

Reference No. .... Bank Guarantee No. .... Dated: .....

### Form 3: Format of Additional Security

*[To be on non-judicial stamp paper of Rupees One Hundred Only (INR 100/-) or appropriate value as per Stamp Act relevant to place of execution, duly signed on each page.]*

Reference No. .... Bank Guarantee No. .... Dated: .....

To:

[MVVNL]

[Address]

Dear Sir/ Madam,

WHEREAS..... *[Insert name of the Lead Consortium Member/ Sole Bidder]* with address ..... *[Insert address of the Lead Consortium Member/ Sole Bidder]* having its registered office at ..... *[Insert address of the Lead Consortium Member/ Sole Bidder]* (hereinafter, the “Contractor”), subsequent to participation in Tender No. [Tender Details] (the “RFP”) issued by [MVVNL] (hereinafter, the “Beneficiary”) for Appointment of AMI Service Provider for Implementation of AMI Project in pre-paid mode, have been issued the Letter of Award as the Selected Bidder. The Selected Bidder was required to incorporate the AMISP. Further the AMISP was required to furnish an additional Security in the form of a Bank Guarantee on behalf of ..... *[Insert names of the Consortium Members]* with address ..... *[Insert addresses of the Consortium Members]* having its registered office at ..... *[Insert address of the Consortium Members]* (hereinafter, the “Consortium Member”), [whose % of equity participation in the SPV to be formed is less than 10%] (OR) [who is not going to be a part of the SPV to be formed]

And WHEREAS a Bank Guarantee for Rupees ..... *[Insert amount in words equivalent]* (.....) *[Insert amount in figures]* valid till..... *[Insert Additional security validity period]* is required to be submitted by the AMISP as per the terms and conditions of the RFP.

We,.....*[Insert name of the Bank and address of the Branch giving the Bank Guarantee]* having our registered office at .....*[Insert address of the registered office of the Bank]* hereby give this Bank Guarantee No. ....*[Insert Bank Guarantee number]* dated .....*[Insert the date of the Bank Guarantee]*, and hereby agree unequivocally and unconditionally to pay immediately on demand in writing from the Beneficiary any officer authorized by it in this behalf any amount not exceeding Rupees ..... *[Insert amount in words]* (.....) *[Insert amount in figures]* to the said Beneficiary on behalf of the Contractor.

We ..... *[Insert name of the Bank]* also agree that non-performance, delayed performance or violation of any of the terms and conditions of the contract by AMISP would constitute a default on the part of the Bidder and that this Bank Guarantee is liable to be invoked and encashed within its validity by the Beneficiary in case of any occurrence of a default on the part of the



AMISP or the Selected Bidder and that the encashed amount is liable to be forfeited by the Beneficiary.

This agreement shall be valid and binding on this Bank up to and inclusive of ..... [Insert the date of validity of the Bank] and shall not be terminable by notice or by Guarantor change in the constitution of the Bank or the firm of the Bidder Or by any reason whatsoever and our liability hereunder shall not be impaired or discharged by any extension of time or variations or alternations made, given, conceded with or without our knowledge or consent by or between the Bidder and the Beneficiary.

NOTWITHSTANDING anything contained hereinbefore, our liability under this guarantee is restricted to Rupees ..... [Insert amount in words equivalent]. Our Guarantee shall remain in force till ..... [Insert the contract period]. Unless demands or claims under this Bank Guarantee are made to us in writing on or before..... [Insert contract period], all rights of the Beneficiary under this Bank Guarantee shall be forfeited, and we shall be released and discharged from all liabilities there under.

*[Insert the address of the Bank with complete postal branch code, telephone and fax numbers, and official round seal of the Bank]*

*[Insert signature of the Bank's Authorized Signatory]*

Attested:

..... [Signature] (Notary Public)

Place: ..... Date: .....

**INSTRUCTIONS FOR SUBMITTING BANK GUARANTEE**

1. Bank Guarantee to be executed on non-judicial stamp paper of appropriate value as per Stamp Act relevant to place of execution.
2. The Bank Guarantee by Bidder shall be given from the Scheduled Commercial Banks.
3. Lead bidder shall execute separate bank guarantees for each of the consortium members, on behalf of whom, the additional security is being provided.

### **Form 4: Format of Bank Guarantee for Advance payment (Optional)**

Bank Guarantee No. ....

Date.....

Contract No.....

.....[Name of Contract].....

To: [Name and address of the Employer]

Dear Ladies and/or Gentlemen,

We refer to the Contract ("the Contract") signed on .....(insert date of the Contract)..... between you and M/s ..... (Name of Contractor) ....., having its Principal place of business at .....(Address of Contractor) ..... and Registered Office at .....(Registered address of Contractor) ..... ("the Contractor") concerning ..... (Indicate brief scope of work) ..... for the complete execution of the ..... (insert name of Package alongwith name of the Project).....

Whereas, in accordance with the terms of the said Contract, the Employer has agreed to pay or cause to be paid to the Contractor an Advance Payment in the amount of .....(Amount in figures and words).....

By this letter we, the undersigned, .....(insert name & address of the issuing bank) ....., a Bank (which expression shall include its successors, administrators, executors and assigns) organized under the laws of ..... and having its Registered/Head Office at .....(insert address of registered office of the bank)..... do hereby irrevocably guarantee repayment of the said amounts upon the first demand of the Employer without cavil or argument in the event that the Contractor fails to commence or fulfill its obligations under the terms of the said Contract, and in the event of such failure, refuses to repay all or part (as the case may be) of the said advance payment to the Employer.

Provided always that the Bank's obligation shall be limited to an amount equal to the outstanding balance of the advance payment, taking into account such amounts, which have been repaid by the Contractor from time to time in accordance with the terms of payment of the said Contract as evidenced by appropriate payment certificates.

This Guarantee shall remain in full force from the date upon which the said advance payment is received by the Contractor upto thirty (30) days beyond the date on which the entire advance so advanced alongwith the interest if any due thereon has been fully adjusted in terms of the Contract i.e., upto of thirty (30) days beyond the date of Completion of the Facilities under the Contract. This Guarantee may be extended from time to time, as may be desired by M/s. .... on whose behalf this Guarantee has been issued.

Any claims to be made under this Guarantee must be received by the Bank during its period of validity, i.e. upto thirty (30) days beyond the date of Completion of the Facilities by the Employer i.e. upto and inclusive of ..... (dd/mm/yy).

For and on behalf of the Bank

[Signature of the authorised signatory(ies)]

Signature \_\_\_\_\_

Name \_\_\_\_\_

Designation \_\_\_\_\_

POA Number \_\_\_\_\_

Contact Number(s): Tel. \_\_\_\_\_ Mobile \_\_\_\_\_

Fax Number \_\_\_\_\_

email \_\_\_\_\_

Common Seal of the Bank \_\_\_\_\_

Witness:

Signature \_\_\_\_\_

Name \_\_\_\_\_

Address \_\_\_\_\_

Contact Number(s): Tel. \_\_\_\_\_ Mobile \_\_\_\_\_

email \_\_\_\_\_

**Note:**

1. For the purpose of executing the Bank Guarantee, the non-judicial stamp papers of appropriate value shall be purchased in the name of Bank who issues the 'Bank Guarantee'.
2. The Bank Guarantee shall be signed on all the pages by the Bank Authorities indicating their POA nos. and should invariably be witnessed.
3. The Bank Guarantee should be in accordance with the proforma as provided. However, in case the issuing bank insists for additional paragraph for limitation of liability, the following may be added at the end of the proforma of the Bank Guarantee [*i.e., end paragraph of the Bank Guarantee preceding the signature(s) of the issuing authority(ies) of the Bank Guarantee*]:

Quote

“Notwithstanding anything contained herein:

1. Our liability under this Bank Guarantee shall not exceed \_\_\_\_\_ (*value in figures*) \_\_\_\_\_ [*value in words*] \_\_\_\_\_].
2. This Bank Guarantee shall be valid upto \_\_\_\_\_ (*validity date*) \_\_\_\_\_.
3. We are liable to pay the guaranteed amount or any part thereof under this Bank Guarantee only & only if we receive a written claim or demand on or before \_\_\_\_\_ (*validity date*) \_\_\_\_\_.”

Unquote

**Form 5: Format for Direct Debit Facility**

<MVVNL shall establish the Direct Debit facility and sign an agreement with the Bank and AMISP to formally institutionalize the Direct debit facility>

### Exhibit-1

#### Section A: Meters (each with related hardware, software and equipment)

Sr.No	Head	Item Description (A)	MVVNL	Quantity in Nos. (B)	Rate per Unit including all taxes and duties other than GST	GST applicable in @ 18%	AMISP Service Charge (in INR/month/meter) (E = C x (1+D%))	Lumpsum (Rs. 900/-) payment per Unit (in INR/meter) (F)	Total cost for each category of meter (G = BX ((E X 90 months) +F))
		Meters (each with related hardware, software and equipment)							
1	Consumer Metering	Single phase Whole current Meter Consumer Metering	MVVNL	71,29,682					
		Three Phase Whole current Meter-Consumer Metering		3,50,994					
		Three Phase LT/CT Meter-Consumer Metering		48,061					
		Three Phase HT/CT Meter-Consumer Metering		0					
		<b>Total(I)</b>		<b>75,28,737</b>					
	System Metering	Single phase Whole current Meter System Metering-Feeder/DT/Boundary	MVVNL	0					
		Three Phase LT-TVM Meter-System Metering-Feeder/DT/Boundary		3,83,158					
		Three Phase HT-TVM System-Metering-Feeder/DT/Boundary		4,800					
		<b>Total(II)</b>		<b>3,87,958</b>					
		<b>Grand Total(I+II)</b>		<b>79,16,695</b>					

**\*Note-** The quantity mentioned is subject to approval, (sanction quantity is 1745 Nos. for feeder metering). Bid would be evaluated on the quantity is mentioned.

**Section B: Auxiliary LT items: Service Cable Supply, Installation, Commissioning & other services**

S. No.	MVVNL	Item Description (H)	Quantity in Kms. (I)	Rate per Unit including all taxes and duties other than GST (in INR) (J)	GST applicable in % (K)	Total cost (L = I X J X (1+K))
<b>Service Cable Supply, Installation, Commissioning &amp; other services</b>						
2	MVVNL	single phase (2CX6sqmm)	31,709.00			
		single phase (2CX10sqmm)	0			
		Three phase (4CX10sqmm)	0			
		Three phase (4CX16sqmm)	9,618.00			
		Three phase (4CX25sqmm)	0			
		<b>Total</b>	<b>41,327.00</b>			

**Section C: New requirement for Software Components**

S.No.	Item Description (H)	Total Estimated Person Days Required (I)	Person Day Rate (J)	Total Cost (K= I X J)
<b>New requirement for software components</b>				
1	Architecture Specialists (Experience- 10+ years)	1X365		
2	Security Specialists (Experience- 10+ years)	1X365		
3	Integration Specialists (Experience- 10+ years)	1X365		

<b>S.No.</b>	<b>Item Description (H)</b>	<b>Total Estimated Person Days Required (I)</b>	<b>Person Day Rate (J)</b>	<b>Total Cost (K= I X J)</b>
4	Data Base Developer- Sr. (Experience- 5+ years)	1X365		
5	Web/ Mobile Application Developer- Sr. (Experience- 5+ years)	1X365		
6	Core Application Developer- Sr. (Experience- 5+ years)	1X365		
7	Data Base Developer- Jr. (Experience- Less than 5 years)	1X365		
8	Web/ Mobile Application Developer- Jr. (Experience- Less than 5 years)	1X365		
9	Core Application Developer- Jr. (Experience- Less than 5 years)	1X365		
	<b>Total</b>			



<b>Exhibit-2</b>			
<b>Discom wise-Phase wise Detail of Divisions</b>			
<b>Discom</b>	<b>Zone</b>	<b>NAME OF DIVISION</b>	
		<b>PHASE-1</b>	<b>PHASE-2</b>
MVVNL	BAREILLY	EDDAWALA	EDDBISAULI
		EDDBAHERI	EDDI BAREILLY
		EDDI BADAUN	EDDISHAHJAHANPUR
		EDDIISHAHJAHANPUR	EDDII BADAUN
		EDDIV UJHANI	EDDII BAREILLY
		EDDJALALABAD	EDDIIIBISALPUR
		EDDPUWAYA	EDDPILIBHIT
		EDDTILHAR	EDDPURANPUR
			EUDDIBAREILLY
			EUDDIIBAREILLY
			EUDDIIBAREILLY
			EUDDIVBAREILLY
	LUCKNOW	EDDBISHWA	EDDBANGARMAU
		EDDGOLA	EDDDALMAU
		EDDHASANGANJ	EDDIHARDOI
		EDDI LAKHIMPUR	EDDISITAPUR
		EDDIRAIBAREILI	EDDIIHARDOI
		EDDIUNNAO	EDDII RAIBAREILI
		EDDII LAKHIMPUR	EDDII SITAPUR
		EDDMAHAMOODABAD	EDDII UNNAO
		EDDMOHAMADI	EDDLALGANJ
		EDDNIGHASAN	EDDMAHRAJGAJ
		EDDPURWA	EDDPALIA
		EDDSALON	EDDSANDILA
		EDDSHAHABAD	

	GONDA	EDDUNCHA HAR	
		EDDBAHRAICH	
		EDDBALRAMPUR	
		EDDI GONDA	
		EDDIIKARNAILGANJ	
		EDDIVMANKAPUR	
		EDDKESERGANJ	
		EDDNANPARA	
		EDDNAWABGANJ	
		EDDSRAVASTI	
		EDDTULSIPUR	
	L.E.S.A. CIS GOMTI	AMINABAD	AISHBAGH
		CHOWK	ALAMBAGH
		EDDII CESS	EDDI CESS
		EDDIV CESS	EDDIIICESS
		KANPURROAD	HUSAINGANJ
		RAJAJI PURAM	RAJBHAWAN
		THAKURGANJ	RESIDENCY
		UPTRON	VRINDAWAN
	L.E.S.A. TRANS GOMTI	BAKSHI KA TALAB	CHINHAT
		DALIGANJ	GOMTINAGAR
		MAHANAGAR	INDIRANAGAR
		UNIVERSITY	MUNSHIPULIYA
			RAHIMNAGAR
			SITAPURROAD
	AYODHYA	EDDAALAPUR	EDDAMETHI
		EDDAKBARPUR	EDDI AYODHYA
		EDDFATEHPUR	EDDIBARABANKI
		EDDGAURAIGANJ	EDDIV AYODHYA
		EDDHAIDERGARH	EDDJAGDISHPUR

---

		EDDISULTANPUR	EDDRAMSENHIGHAT
		EDDII AYODHYA	
		EDDII BARABANKI	
		EDDIISULTANPUR	
		EDDIIIAYODHYA	
		EDDJAISINGHPUR	
		EDDJALALPUR	
		EDDKADIPUR	
		EDDLUMBHUA	

**EXHIBIT-3****No. Of Consumers (As per approved DPR)%&**

<b>MVVNL</b>	<b>Phase-1</b>	<b>Phase-2</b>	<b>Grand Total</b>
MVVNL	56,46,552	18,82,185	75,28,737

**No. Of 11 KV Feeders and DTs (As per approved DPR)%&**

<b>MVVNL wise Feeder</b>
1,745
<b>MVVNL wise DT</b>
3,83,158

**EXHIBIT-4****Estimated Project Cost (sanctioned)**

<b>Sr. No</b>	<b>MVVNL</b>	<b>Estimated Project COST IN Cr.</b>
1	MVVNL	5009.35+445.51= <b>5454.86</b>

## Exhibit-5

रजिस्ट्री सं. डी.एल.-33004/99

REGD. No. D. L.-33004/99



**भारत का राजपत्र**  
**The Gazette of India**

सी.जी.-डी.एल.-अ.-19082021-229126  
CG-DL-E-19082021-229126

असाधारण  
EXTRAORDINARY

भाग I—खण्ड 1  
PART I—Section 1

प्राधिकार से प्रकाशित  
PUBLISHED BY AUTHORITY

सं. 230]  
No. 230]

नई दिल्ली, बृहस्पतिवार, अगस्त 19, 2021/श्रावण 28, 1943  
NEW DELHI, THURSDAY, AUGUST 19, 2021/SRAVANA 28, 1943

विद्युत मंत्रालय

अधिसूचना

नई दिल्ली, 17 अगस्त, 2021

**फा.सं. 23/35/2019-आरएण्डआर.**—विद्युत अधिनियम, 2003 की धारा 177 की उप धारा (2) के खंड (ग) के साथ पठित धारा 55 की उप धारा (1) के अंतर्गत बनाए गए केंद्रीय विद्युत प्राधिकरण (मीटरों का अधिग्रहण और प्रचालन) (संशोधन) विनियम, 2019 के खंड 4(1)(ख) के प्रावधानों के अनुसरण में, केंद्र सरकार एतद्वारा मौजूदा मीटरों को पूर्व भुगतान सुविधा वाले स्मार्ट मीटरों से प्रतिस्थापित करने के लिए निम्नलिखित समय-सीमा अधिसूचित करती है:

1. संचार नेटवर्क युक्त क्षेत्रों के सभी उपभोक्ताओं (कृषि उपभोक्ताओं को छोड़कर) को, नीचे विनिर्दिष्ट समय-सीमा के भीतर, पूर्व भुगतान मोड में कार्य कर रहे स्मार्ट मीटरों से विद्युत की आपूर्ति, प्रासंगिक आईएस के अनुरूप, की जाएगी:
  - (i) सभी संघ राज्य क्षेत्रों, वित्तीय वर्ष 2019-20 में 15% से अधिक एटी एंड सी हानियों के साथ शहरी क्षेत्रों में 50% अधिक से उपभोक्ता वाले विद्युत मंडलों, वित्तीय वर्ष 2019-20 में 25% से अधिक एटी एंड सी हानियों वाले अन्य विद्युत मंडलों, ब्लॉक स्तर या उससे ऊपर के सभी सरकारी कार्यालयों और सभी औद्योगिक तथा वाणिज्यिक उपभोक्ताओं को दिसंबर, 2023 तक पूर्व भुगतान मोड वाले स्मार्ट मीटरों से मीटरीकृत किया जाएगा:

परंतु कि राज्य विनियामक आयोग, अधिसूचना के माध्यम से, उस अधिसूचना में यथा विनिर्दिष्ट उपभोक्ताओं के एक वर्ग या वर्गों के लिए या ऐसे क्षेत्रों के लिए कारण बताते हुए, कार्यान्वयन की उक्त अवधि को केवल दो बार, लेकिन एक बार में छह माह से अधिक बढ़ाया नहीं बढ़ा सकेगा।

- (ii) अन्य सभी क्षेत्रों को मार्च, 2025 तक पूर्व भुगतान मोड वाले स्मार्ट मीटरों से मीटरीकृत किया जाएगा:

परंतु कि ऐसे क्षेत्रों में जहां संचार नेटवर्क उपलब्ध नहीं हैं, संबंधित राज्य विद्युत विनियामक आयोग द्वारा, प्रासंगिक आईएस के अनुरूप, पूर्व भुगतान मीटरों के अधिष्ठापन की अनुमति दी जा सकेगी:

- (iii) सभी उपभोक्ता कनेक्शनों, जिनकी वर्तमान वहन क्षमता प्रासंगिक आई एस में विनिर्दिष्ट क्षमता से अधिक है, को ऐसे मीटर उपलब्ध कराए जाएंगे जो एएमआर सुविधा युक्त स्मार्ट मीटर हैं।

2. सभी फीडरों और वितरण ट्रांसफार्मरों (डीटीज) को नीचे विनिर्दिष्ट समय-सीमा के अनुसार एएमआर सुविधा युक्त या एएमआई के अंतर्गत शामिल मीटर उपलब्ध कराए जाएंगे:

- (i) सभी फीडरों को दिसंबर, 2022 तक मीटरीकृत कर दिया जाएगा।

- (ii) वित्तीय वर्ष 2019-20 में 15% से अधिक एटी एंड सी हानियों वाले शहरी क्षेत्रों में 50% से अधिक उपभोक्ता वाले विद्युत मंडलों और वित्तीय वर्ष 2019-20 में 25% से अधिक एटी एंड सी हानियों वाले सभी अन्य विद्युत मंडलों में सभी डीटीज को दिसंबर, 2023 तक मीटरीकृत किया जाएगा।

- (iii) उपरोक्त (ii) में उल्लिखित क्षेत्रों के अतिरिक्त अन्य सभी डीटीज को मार्च, 2025 तक मीटरीकृत किया जाएगा।

- (iv) 25 केवीए से कम क्षमता वाले डीटीज और एचवीडीएस ट्रांसफार्मरों को उपरोक्त समय-सीमा से बाहर रखा जाएगा।

3. यह अधिसूचना भारत के राजपत्र में प्रकाशित होने की तारीख से प्रभावी होगी।

घनश्याम प्रसाद, संयुक्त सचिव

#### MINISTRY OF POWER

#### NOTIFICATION

New Delhi, the 17th August, 2021

**F.No. 23/35/2019-R&R.**—In pursuance to the provisions made in clause 4(1) (b) of the Central Electricity Authority (Installation and Operation of Meters) (Amendment) Regulations, 2019 framed under sub-section (1) of section 55 read with clause(c) of sub-section (2) of section 177 of the Electricity Act, 2003, the Central Government hereby notifies the following timelines for the replacement of existing meters with smart meters with prepayment feature:

1. All consumers (other than agricultural consumers) in areas with communication network, shall be supplied electricity with Smart Meters working in prepayment mode, conforming to relevant IS, within the timelines specified below:

(i) All Union Territories, electrical divisions having more than 50% consumers in urban areas with AT&C losses more than 15% in financial year 2019-20, other electrical divisions with AT&C losses more than 25% in financial year 2019-20, all Government offices at Block level and above, and all industrial and commercial consumers, shall be metered with smart meters with prepayment mode by December, 2023:

Provided that the State Regulatory Commission may, by notification, extend the said period of implementation, giving reasons to do so, only twice but not more than six months at a time, for a class or classes of consumers or for such areas as may be specified in that notification;

- (ii) All other areas shall be metered with smart meters with prepayment mode by March, 2025:  
Provided that in areas which do not have communication network, installation of prepayment meters, conforming to relevant IS, may be allowed by the respective State Electricity Regulatory Commission:
- (iii) All consumer connections having current carrying capacity beyond that specified in relevant IS, may be provided with meters with smart meters having AMR facility.
2. All feeders and distribution transformers (DTs) shall be provided with meters having AMR facility or covered under AMI, as per the timelines specified below:
- (i) All feeders shall be metered by December, 2022.
- (ii) All DTs in electrical divisions having more than 50% consumers in urban areas with AT&C losses more than 15% in financial year 2019-20, and in all other electrical divisions with AT&C losses more than 25% in financial year 2019-20, shall be metered by December, 2023.
- (iii) All DTs in areas other than those mentioned in (ii) above, shall be metered by March, 2025.
- (iv) DTs and HVDS transformers having capacity less than 25 kVA may be excluded from the above timelines.
3. This notification shall be effective from the date of publishing in the Gazette of India.

GHANSHYAM PRASAD, Jt. Secy.